

7 6 5 4 3 2 1

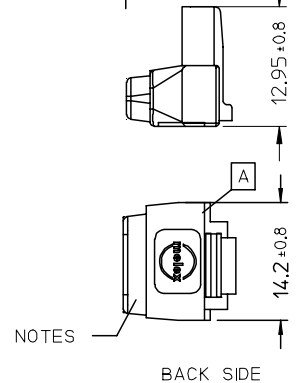
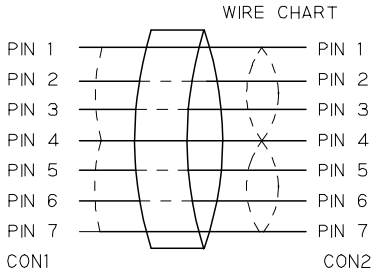
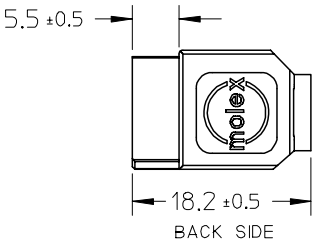
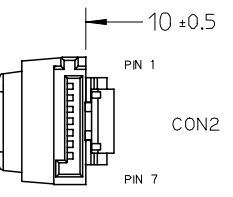
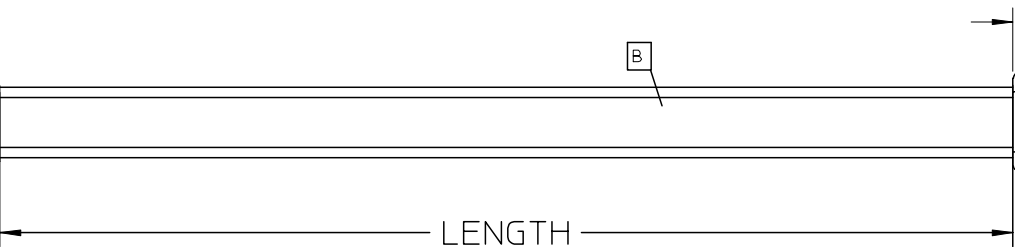
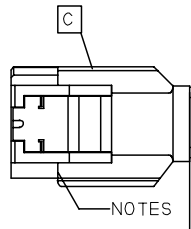
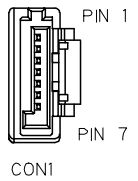

NOTE:
 PHYSICAL
 1. OUTER MOLD WITH BLACK PVC RESIN 887800042.
 INNER MOLD WITH PE RESIN 887800008.
 ELECTRICAL PERFORMANCE:
 2. DIELECTRONIC STRENGTH:500V DC/0.01S.
 3. INSULATION RESISTANCE:100M OHMS MIN.
 4. CONDUCTIVE RESISTOR: 2 OHMS MAX.

MOLEX P/N	LENGTH (mm)	LENGTH (inch)	DESCRIPTION
68561-0017	1000+/-20	40.0+/-0.8	S-ATA LATCHING STRAIGHT TO R/A CABLE. RED
68561-0016	500+/-10	20.0+/-0.4	S-ATA LATCHING STRAIGHT TO R/A CABLE. RED

ITEM	DESCRIPTION	QTY.
C	S-ATA STRAIGHT CONN. 674899002	1
B	2PX26AWG S-ATA CABLE RED 887808052	1
A	S-ATA R/A CONN. 674890002	1

ENTER DESCRIPTION EC NO: DG2005-0125 DRWN: JLIU13 CHKD: TEDDY APPR: TKAN	2005/04/04 2005/04/04 2005/04/04	DESCRIPTION REV	QUALITY SYMBOLS	GENERAL TOLERANCES (UNLESS SPECIFIED)	DIMENSION STYLE	SCALE	DESIGN UNITS	THIRD ANGLE PROJECTION
			▼=0 □=0	mm INCH	MM ONLY	---	METRIC	
			4 PLACES ±--- ±--- 3 PLACES ±--- ±--- 2 PLACES ±--- ±--- 1 PLACE ±--- ±---	DRAWN BY: JLIU13 DATE: 2005/04/04 CHECKED BY: TEDDY DATE: 2005/04/04 APPROVED BY: BORON DATE: 2005/04/04	TITLE			
			ANGULAR ±---° DRAFT WHERE APPLICABLE MUST REMAIN WITHIN DIMENSIONS	MATERIAL NO. 685610017 DOCUMENT NO. SD-68561-0017 SHEET NO. 1 OF 1	S-ATA STRAIGHT LATCHING TO R/A LATCHING SIGNAL CBL RED,0.5M,1.0M MOLEX INCORPORATED			

6 5 4 3 2 1

THIS DRAWING CONTAINS INFORMATION THAT IS PROPRIETARY TO MOLEX INCORPORATED AND SHOULD NOT BE USED WITHOUT WRITTEN PERMISSION

7 6 5 4 3 2 1

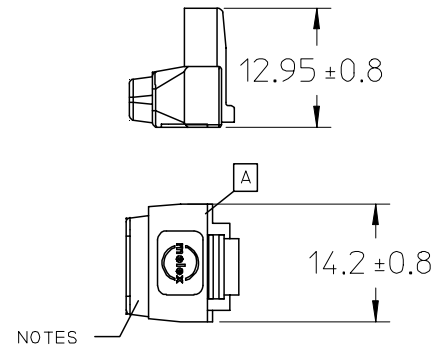
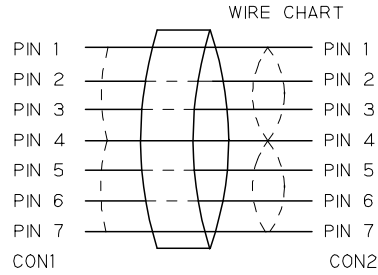
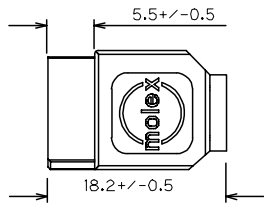
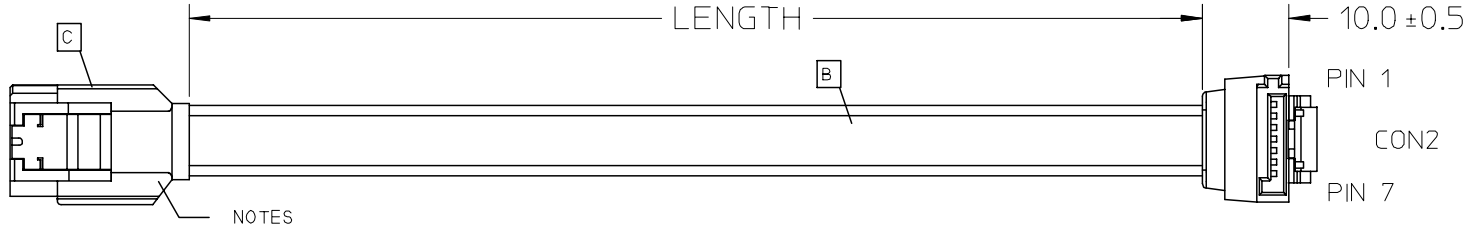
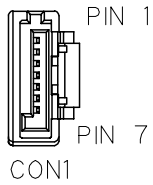

NOTE:
PHYSICAL

1. OUTER MOLD WITH BLACK PVC RESIN 887800042

ELECTRICAL PERFORMANCE:
2. DIELECTRONIC STRENGTH:500V DC
3. INSULATION RESISTANCE:100M OHMS
4. CONDUCTIVE RESISTOR: 2 OHMS

MOLEX P/N	LENGTH (mm)	LENGTH (inch)	DESCRIPTION
68561-0017	1000+/-20	40.0+/-0.8	S-ATA LATCHING STRAIGHT TO R/A CABLE. RED
68561-0016	500+/-10	20.0+/-0.4	S-ATA LATCHING STRAIGHT TO R/A CABLE. RED

ITEM	DESCRIPTION	L	QTY.
C	S-ATA STRAIGHT CONN. 674899002		1
B	2PX26AWG S-ATA CABLE RED 887808052	N/A	1
A	S-ATA R/A CONN. 674890002		1

ENTER DESCRIPTION EC NO: DG2005-0009 DRWN:GXYANG CHKD: APPR:BOCHEN	2004/08/11 2004/08/18 2004/08/18	QUALITY SYMBOLS ▽=0 ◻=0	GENERAL TOLERANCES (UNLESS SPECIFIED)		DIMENSION STYLE MM ONLY		SCALE ---	DESIGN UNITS METRIC	THIRD ANGLE PROJECTION			
				mm	INCH	DRAWN BY GX YANG	DATE 04/08/10	TITLE S-ATA STRAIGHT LATCHING TO R/A LATCHING SIGNAL CBL RED,0.5M,1.0M				
			4 PLACES	±---	±---	CHECKED BY TEDDY	DATE 04/08/10					
			3 PLACES	±---	±---	APPROVED BY BORON	DATE 04/08/10	MOLEX INCORPORATED DOCUMENT NO. SD-68561-002 SHEET NO. 1 OF 1				
2 PLACES	±---	±---	MATERIAL NO. 685610016/7									
1 PLACE	±---	±---	DRAFT WHERE APPLICABLE MUST REMAIN WITHIN DIMENSIONS		SIZE A/4		THIS DRAWING CONTAINS INFORMATION THAT IS PROPRIETARY TO MOLEX INCORPORATED AND SHOULD NOT BE USED WITHOUT WRITTEN PERMISSION					
ANGULAR ±---°												

6 5 4 3 2 1