

The ET Series of Thermoelectric Modules (TEMs) are designed to operate in high temperature environments.

This product line is available in multiple configurations and is ideal for applications that operate in temperatures above 80°C. Assembled with Bismuth Telluride semiconductor material, thermally conductive Aluminum Oxide ceramics and high temp solder construction, the ET Series is designed for higher current and larger heat-pumping applications.

Americas: +1.919.597.7300
Europe: +46.31.420530
Asia: +86.755.2714.1166
ets.sales@lairdtech.com
www.lairdtech.com

FEATURES

- High temperature operation
- Reliable solid-state
- No sound or vibration
- Environmentally friendly
- RoHS compliant

APPLICATIONS

- Automotive Cooling
- Telecom Cooling
- Outdoor Environments
- Medical Heating/Cooling

SPECIFICATIONS

TECHNICAL		
Hot Side Temperature (°C)	85°C	110°C
Qmax (Watts)	62.5W	64W
Delta Tmax (°C)	87°C	94°C
I _{max} (Amps)	6.0A	6.0A
V _{max} (Volts)	16.9V	18.2 V
Module Resistance (Ohms)	2.88 Ohms	3.19 Ohms

SUFFIX	THICKNESS (PRIOR TO TINNING)	FLATNESS & PARALLELISM	HOT FACE	COLD FACE	LEAD LENGTH
TA	0.150"±0.010"	0.001"/0.001"	Lapped	Lapped	6"
TB	0.150"±0.0005"	0.0005"/0.0005"	Lapped	Lapped	6"

SEALING OPTIONS

SUFFIX	SEALANT	COLOR	TEMP RANGE	DESCRIPTION
RT	RTV	Clear	-60 to 204 °C	Non-corrosive, silicone adhesive
EP	Epoxy	Black	-55 to 150 °C	Low density syntactic foam epoxy encapsulant
RL	RTV	Clear	-45 to 200 °C	silicone adhesive ,Low outgassing application

Performance Curves at Th = 85°C

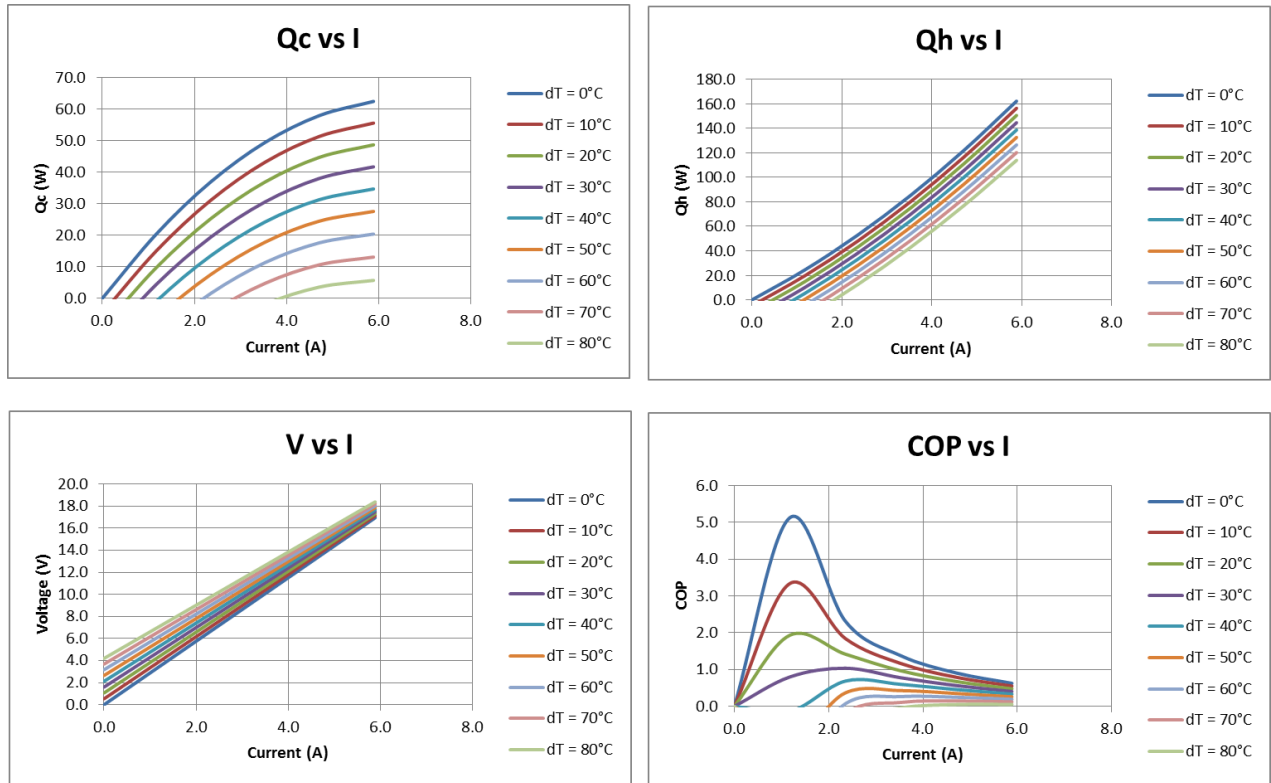

Mechanical Drawing

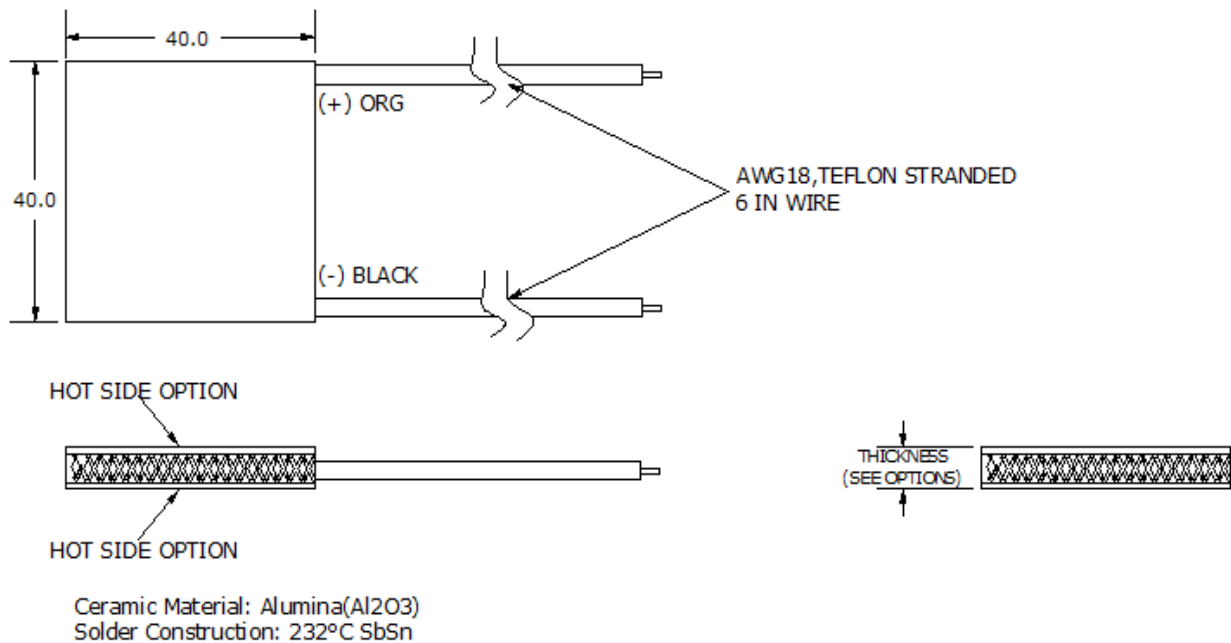

NOTES

1. Max Operating Temperature: 150°C
2. Do not exceed I_{max} or V_{max} when operating module
3. Reference assembly guidelines for recommended installation

LAIRD-ETS-ET6,127,F1,4040 DATA-SHEET-101416

Any information furnished by Laird Technologies, Inc. and its agents is believed to be accurate and reliable. All specifications are subject to change without notice. Responsibility for the use and application of Laird Technologies materials rests with the end user. Laird Technologies makes no warranties as to the fitness, merchantability, suitability or non- infringement of any Laird Technologies materials or products for any specific or general uses. Laird Technologies shall not be liable for incidental or consequential damages of any kind. All Laird Technologies products are sold pursuant to the Laird Technologies' Terms and Conditions of sale in effect from time to time, a copy of which will be furnished upon request. © Copyright 2016 Laird Technologies, Inc. All Rights Reserved. Laird, Laird Technologies, the Laird Technologies Logo, and other marks are trademarks or registered trademarks of Laird Technologies, Inc. or an affiliate company thereof. Other product or service names may be the property of third parties. Nothing herein provides a license under any Laird Technologies or any third party intellectual property rights.