

**ARM[®] Cortex[®]-M
32-bit Microcontroller**

**NuMicro[®] Family
NuTiny-SDK-MINI57
User Manual**

The information described in this document is the exclusive intellectual property of Nuvoton Technology Corporation and shall not be reproduced without permission from Nuvoton.

Nuvoton is providing this document only for reference purposes of NuMicro[®] microcontroller based system design. Nuvoton assumes no responsibility for errors or omissions.

All data and specifications are subject to change without notice.

For additional information or questions, please contact: Nuvoton Technology Corporation.

www.nuvoton.com

Table of Contents

1 OVERVIEW 4

2 NUTINY-SDK-MINI57 INTRODUCTION 5

 2.1 NuTiny-SDK-MINI57 Jumper Description 6

 2.1.1 Power Setting..... 6

 2.1.2 Debug Connector 6

 2.1.3 USB Connector..... 6

 2.1.4 Extended Connector 6

 2.1.5 Reset Button..... 6

 2.1.6 Power Connector 6

 2.1.7 VCOM Enable 6

 2.2 Pin Assignment for Extended Connector 8

 2.3 NuTiny-SDK-MINI57 PCB Placement 9

3 How to Start NuTiny-SDK-MINI57 on the Keil μ Vision[®] IDE 10

 3.1 Downloading and Installing Keil uVision[®] IDE Software 10

 3.2 Downloading and Installing Nuvoton Nu-Link Driver 10

 3.3 Hardware Setup..... 10

 3.4 Example Program..... 10

4 How to Start NuTiny-SDK-MINI57 on the IAR Embedded Workbench 12

 4.1 Downloading and Installing IAR Embedded Workbench Software 12

 4.2 Downloading and Installing Nuvoton Nu-Link Driver 12

 4.3 Hardware Setup..... 12

 4.4 Example Program..... 12

5 Starting to Use Nu-Link-Me 3.0 VCOM Function..... 14

 5.1 Downloading and Installing VCOM Driver 14

 5.2 VCOM Mode Setting on NuTiny-SDK-MINI57 15

 5.3 Development Tool Setup 15

 5.3.1 Check the Using UART on the Keil μ Vision[®] IDE..... 15

 5.3.2 Check the Target Device and Debug Setting 16

 5.3.3 Build and Download Code to NuTiny-SDK-MINI57..... 18

 5.3.4 Open the Serial Port Terminal 18

 5.3.5 Reset Chip 18

6 NuTiny-SDK-MINI57 Schematics 20

 6.1 NuTiny-EVB-MINI57 Schematic 20

6.2 GPIO for 28 pin Schematic21

6.3 SDK Circuit Schematic.....22

6.4 Nu-Link-Me V3.0 Schematic23

7 REVISION HISTORY 24

1 OVERVIEW

NuTiny-SDK-Mini57 is a specific development tool for NuMicro® Mini57 series. With the NuTiny-SDK-Mini57, user can develop and verify the application program easily.

The NuTiny-SDK-Mini57 includes two portions. One is NuTiny-EVB-Mini57 and the other is Nu-Link-Me. NuTiny-EVB-Mini57 is the evaluation board and Nu-Link-Me is its Debug Adaptor. Thus, user does not need other additional ICE or debug equipment.

The Mini57 series can bridge the gap and replace the cost equivalent to traditional 8- and 16-bit microcontroller by 32-bit performance and rich functions. The Mini57 series supports a wide range of applications from low-end, price sensitive designs to computing-intensive ones and provides advanced high-end features in economical products.

The Mini57 series can run up to 48 MHz and operate at 2.1V ~ 5.5V, -40°C ~ 105°C, and thus can support a variety of industrial control applications which need high CPU performance. The Mini57 offers 29.5 Kbytes embedded program Flash, size configurable Data Flash (shared with program flash), 2 Kbytes Flash for the ISP, 1.5 Kbytes SPROM for security, and 4 Kbytes SRAM.

The Mini57 series has many high-performance peripheral functions, such as 48 MHz internal RC oscillator ($\pm 1\%$ accuracy), I/O port with up to 22 pins, three 32-bit timers, two USCI can configure this controller as UART, SPI, or I²C functional protocol, up to four 16-bit PWM generators providing eight channels, an 8-channel 12-bit ADC, Watchdog Timer, two Analog Comparators and a Brown-out Detector. All these peripherals have been incorporated into the Mini57 series to reduce component count, board space and system cost.

Additionally, the Mini57 series is equipped with ISP (In-System Programming) and ICP (In-Circuit Programming) functions, which allow the user to update the program memory without removing the chip from the actual end product. The Mini57 series also supports In-Application-Programming (IAP) function, user switches the code executing without the chip reset after the embedded flash updated.

2 NUTINY-SDK-MINI57 INTRODUCTION

The NuTiny-SDK-MINI57 uses the MINI57EDE as the target microcontroller. Figure 2-1 is NuTiny-SDK-MINI57 for the Mini57 series, the left portion is called NuTiny-EVB-MINI57 and the right portion is Debug Adaptor called Nu-Link-Me.

The NuTiny-EVB-MINI57 is similar to other development boards. Users can use it to develop and verify applications to emulate the real behavior. The on board chip covers MINI57 series features. The NuTiny-EVB-Mini57 can be a real system controller to design user's target systems.

Nu-Link-Me is a Debug Adaptor. The Nu-Link-Me Debug Adaptor connects your PC's USB port to your target system (via Serial Wired Debug Port) and allows you to program and debug embedded programs on the target hardware. The Nu-Link-Me V3.0 also supports VCOM function, which gives users more flexibility when debugging. To use the Nu-Link-Me Debug adaptor with IAR or Keil, please refer to "Nuvoton NuMicro® IAR ICE driver user manual" or Nuvoton NuMicro® Keil ICE driver user manual" in detail. These two documents will be stored in the local hard disk when the user installs each driver. To use Nu-Link-Me 3.0 VCOM function, please refer to Chapter 5.

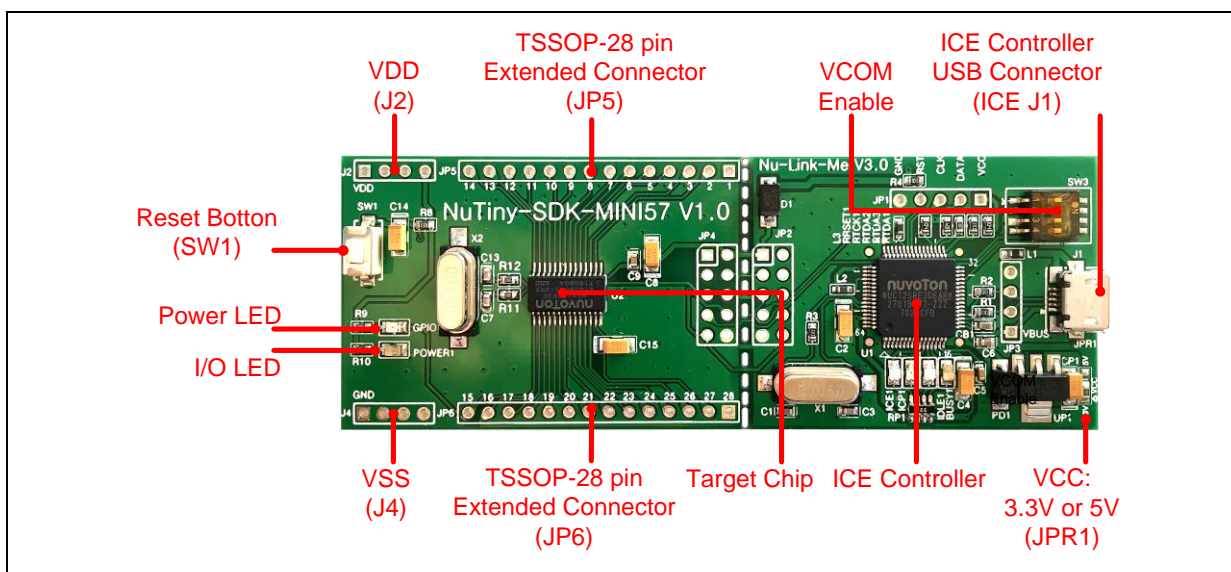

Figure 2-1 NuTiny-SDK-MINI57 (PCB Board)

2.1 NuTiny-SDK-MINI57 Jumper Description

2.1.1 Power Setting

- J1: USB port in Nu-Link-Me
- J2: V_{DD} Voltage connector in NuTiny-EVB-MINI57

Model	JPR1	J1 USB port	J2 V_{DD}	MCU Voltage
Model 1	Select VCC33 (default)	Connect to PC	DC 3.3V output	DC 3.3V
Model 2	X	X	DC 2.1 V ~ 5.5 V Input	Voltage by J2 input

X: Unused.

2.1.2 Debug Connector

- **JP4:** Connector in target board (NuTiny-EVB-MINI57) for connecting with Nuvoton ICE adaptor (Nu-Link-Me V3.0)
- **JP2:** Connector in ICE adaptor (Nu-Link-Me V3.0) for connecting with a target board (for example NuTiny-EVB-MINI57)

2.1.3 USB Connector

- **J1:** Micro USB Connector in Nu-Link-Me V3.0 connected to a PC USB port

2.1.4 Extended Connector

- **JP5, JP6:** Show all chip pins in NuTiny-EVB-MINI57

2.1.5 Reset Button

- **SW1:** Reset button in NuTiny-EVB-MINI57

2.1.6 Power Connector

- **J2:** V_{DD} connector in NuTiny-EVB-MINI57
- **J4:** V_{SS} connector in NuTiny-EVB-MINI57

2.1.7 VCOM Enable

- **SW3:** VCOM function enable for the NuTiny-SDK-MINI57. Switch SW3 on before power on to enable VCOM function. SW3 connects pin 2(PD.6/RXD) and pin 19(PD.5/TXD) in NuTiny-EVB-MINI57 with pin 22(PB.1/TXD) and pin 21(PB.0/RXD) in Nuvoton ICE adaptor (Nu-Link-Me V3.0). SW3 connects pin 29(VCOM) in Nuvoton ICE adaptor (Nu-Link-Me V3.0) to GND to enable VCOM function.

Switch Pin Number	Function Name	UART0 Mode	VCOM Mode
1	ICE_TX	Off	On
2	ICE_RX	Off	On
3	VCOM_EN	Off	On
4	X	X	X

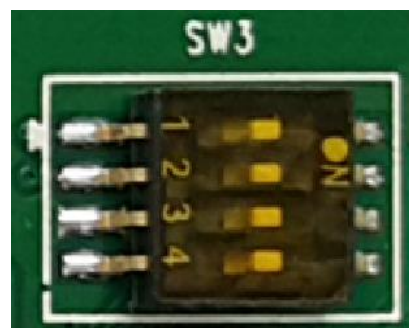

X: Unused.

2.2 Pin Assignment for Extended Connector

The NuTiny-EVB-MINI57 provides MINI57EDE on board and the extended connector (**JP5** and **JP6**) for TSSOP-28 pin. Table 2-1 is the pin assignment for MINI57EDE.

Pin No	Pin Function
1	V _{DD}
2	PD.6/UART0_RXD
3	PB.0/ADC0_CH0/ACMP0_P0/ECAP_P0
4	PB.1/ADC0_CH1/ACMP0_P1/ECAP_P1
5	PB.2/ADC0_CH2/BPWM_CH1/ACMP0_P2/ECAP_P2
6	PB.4/ADC1_CH0/ACMP0_N/TM1
7	PC.1/ADC0_CH4/STADC/ACMP0_P3/ACMP1_P1/SPI0_MOSI/SPI1_MISO
8	nRESET
9	PB.3/ACMP1_N/PGA_I/TM0
10	PC.2/ADC1_CH2/BRAKE/CCAP_P1/I2C1_SDA/SPI0_MISO/SPI1_MOSI/UART1_RXD
11	PD.2/ICE_DAT/ADC1_CH1/CCAP_P0/I2C0_SDA/SPI0_MOSI/SPI1_MISO/UART0_RXD
12	PD.3/BPWM_CH1/UART1_TXD
13	NC
14	NC
15	PC.0/ADC0_CH3/BPWM_CH0/ACMP1_P0/I2C1_SCL/SPI0_SS/SPI1_CLK/UART1_TXD
16	PD.4/BPWM_CH0/UART1_RXD
17	PD.1/ICE_CLK/ACMP1_P2/I2C0_SCL/SPI0_CLK/SPI1_SS/UART0_TXD
18	PC.3/ACMP1_O/PGA_O/SPI0_CLK/SPI1_SS
19	PD.5/UART0_TXD
20	PA.5/XT_OUT/EPWM_CH5/ACMP0_O
21	PA.4/XT_IN/EPWM_CH4
22	PA.3/EPWM_CH3/I2C0_SCL/SPI0_CLK/SPI1_SS/UART0_TXD
23	PA.2/EPWM_CH2/I2C0_SDA/SPI0_MOSI/SPI1_MISO/UART0_RXD
24	PA.1/EPWM_CH1/I2C1_SDA/SPI0_MISO/SPI1_MOSI/UART1_RXD
25	PA.0/CLKO/EPWM_CH0/I2C1_SCL/SPI0_SS/SPI1_CLK/UART1_TXD
26	LDO_CAP
27	P2.6,PWM0_CH4,ACMP1_O
28	V _{SS}

Table 2-1 Pin Assignment for MINI57EDE

2.3 NuTiny-SDK-MINI57 PCB Placement

Figure 2-2 shows the NuTiny-SDK-MINI57 PCB placement.

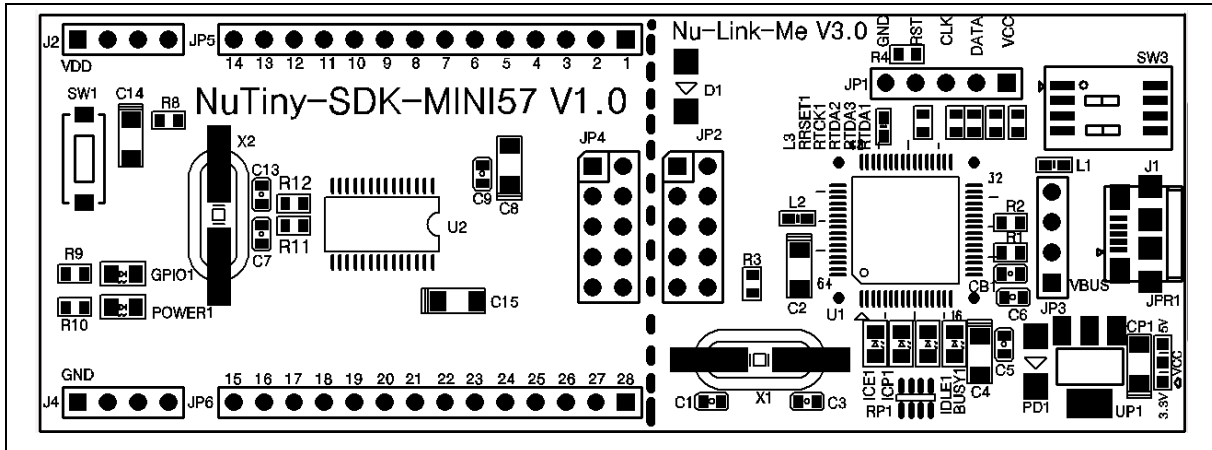

Figure 2-2 NuTiny-SDK-MINI57 PCB Placement

3 HOW TO START NUTINY-SDK-MINI57 ON THE KEIL MVISION® IDE

3.1 Downloading and Installing Keil uVision® IDE Software

Please visit the Keil company website (<http://www.keil.com>) to download the Keil μ Vision® IDE and install the RVMDK

3.2 Downloading and Installing Nuvoton Nu-Link Driver

Please visit the official Nuvoton NuMicro® website (<http://www.nuvoton.com/NuMicro>) to download “NuMicro® Keil μ Vision® IDE driver” file. When the Nu-Link driver has been well downloaded, please unzip the file and execute the “Nu-Link_Keil_Driver.exe” to install the driver.

3.3 Hardware Setup

The hardware setup is shown as Figure 3-1.

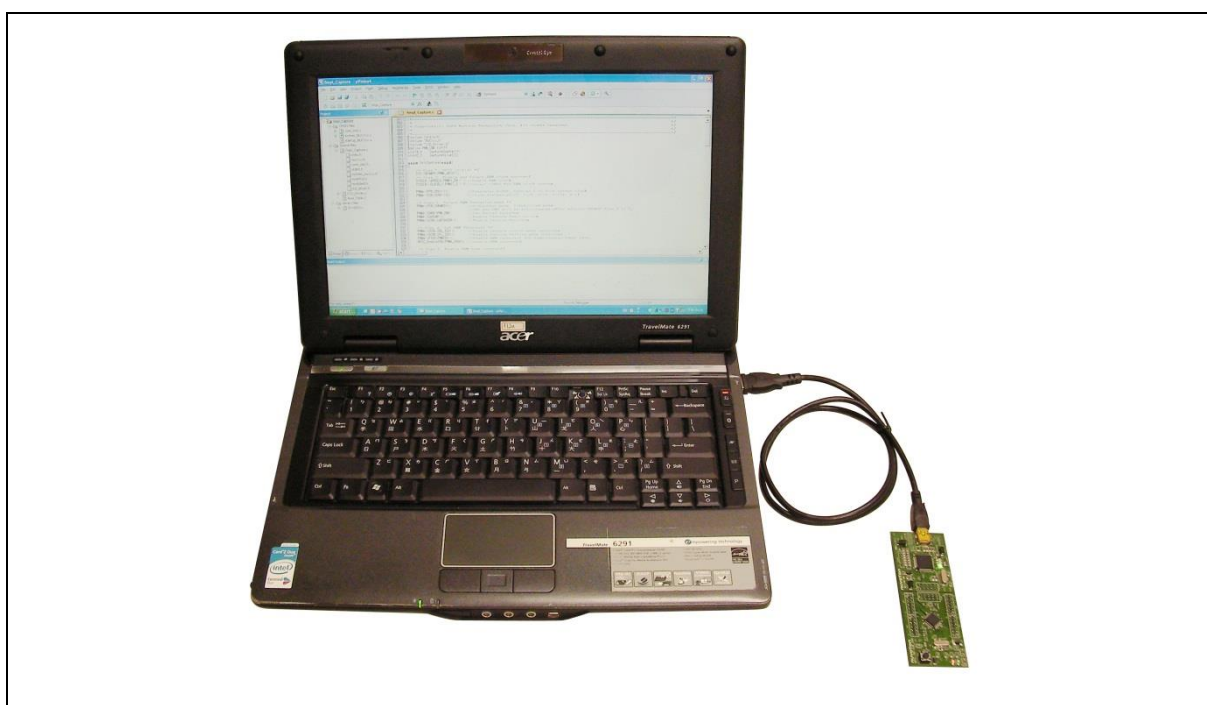

Figure 3-1 NuTiny-SDK-MINI57 Hardware Setup

3.4 Example Program

This example demonstrates downloading and debugging an application on a NuTiny-SDK-MINI57 board. It can be found on Figure 3-2 list directory and downloaded from Nuvoton NuMicro® website.

The example file can be found in the directory list shown in Figure 3-2.

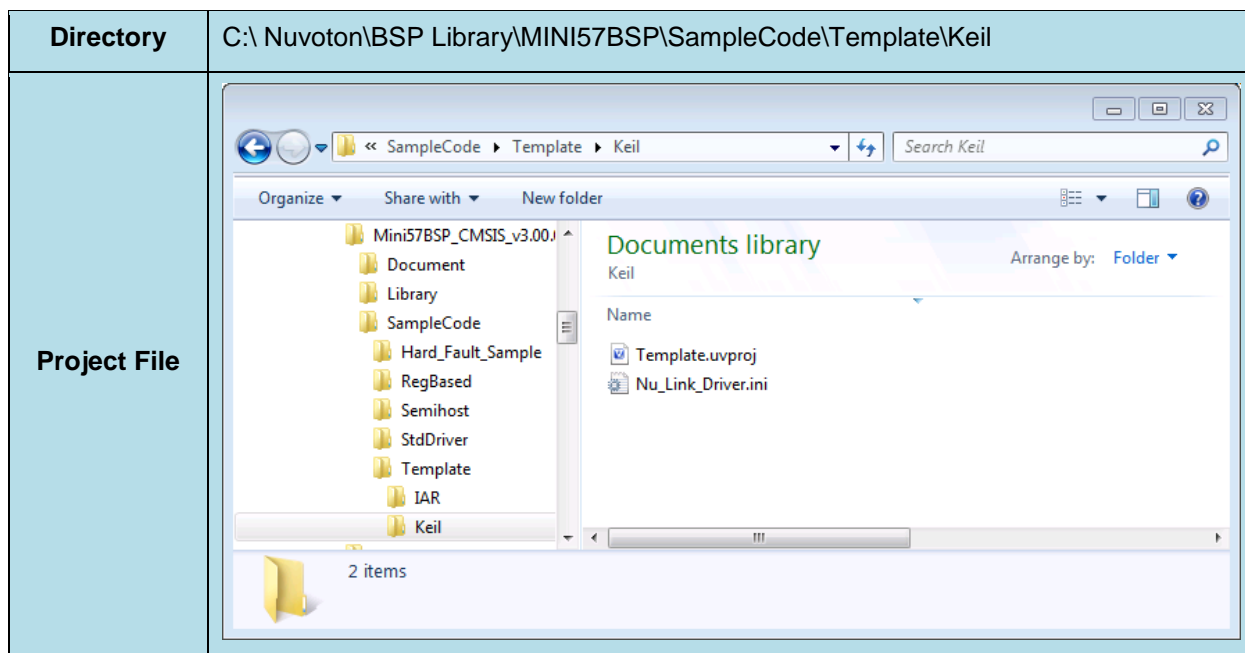









Figure 3-2 Example Directory

This sample code will show some functions about system manager controller and clock controller.

-  Start uVision®
- Project – Open
Open the SYS.uvproj project file
-  Project – Build
Compile and link the SYS application
-  Flash – Download
Program the application code into on-chip Flash ROM
-  Start debug mode
When using the debugger commands, you may:
 - ◆  Review variables in the watch window
 - ◆  Single step through code
 - ◆  Reset the device
 - ◆  Run the application

4 HOW TO START NUTINY-SDK-MINI57 ON THE IAR EMBEDDED WORKBENCH

4.1 Downloading and Installing IAR Embedded Workbench Software

Please connect to IAR company website (<http://www.iar.com>) to download the IAR Embedded Workbench and install the EWARM.

4.2 Downloading and Installing Nuvoton Nu-Link Driver

Please visit the official Nuvoton NuMicro® website (<http://www.nuvoton.com/NuMicro>) to download the “NuMicro® IAR EWARM Driver” file. When the Nu-Link driver has been well downloaded, please unzip the file and execute the “Nu-Link_Keil_Driver.exe” to install the driver.

4.3 Hardware Setup

The hardware setup is shown as Figure 4-1.

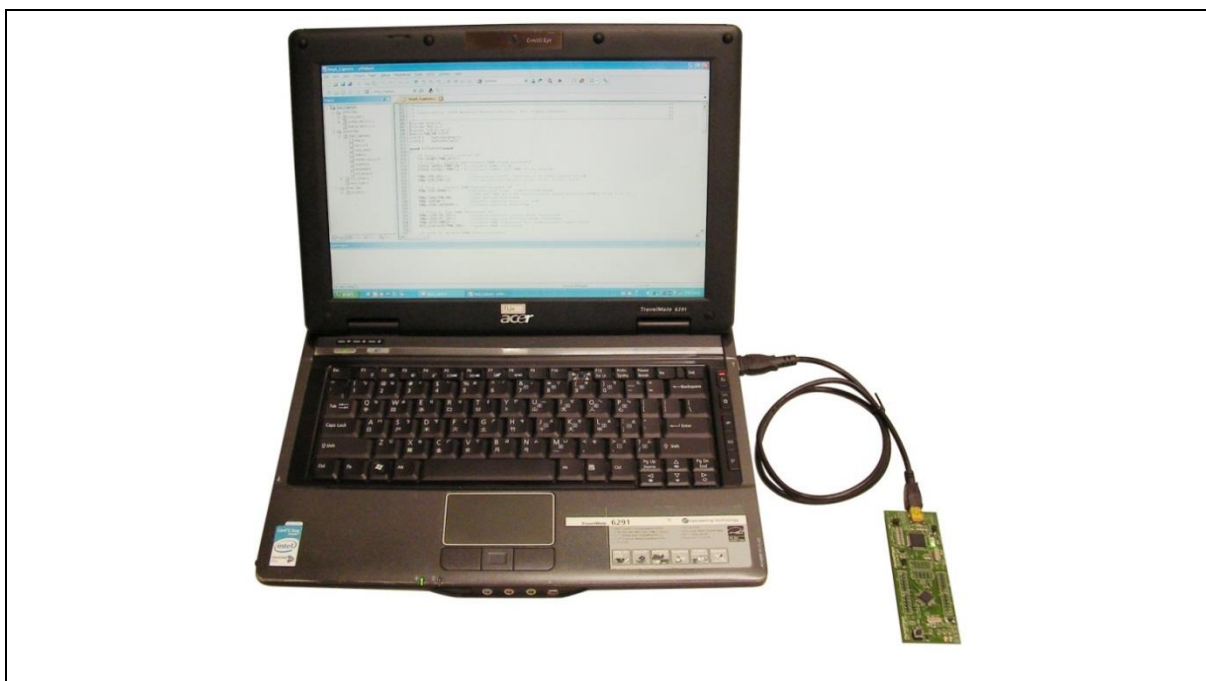

Figure 4-1 NuTiny-SDK-MINI57 Hardware Setup

4.4 Example Program

This example demonstrates downloading and debugging an application on a NuTiny-SDK-MINI57 board. It can be found on Figure 4-2 list directory and downloaded from Nuvoton NuMicro® website.

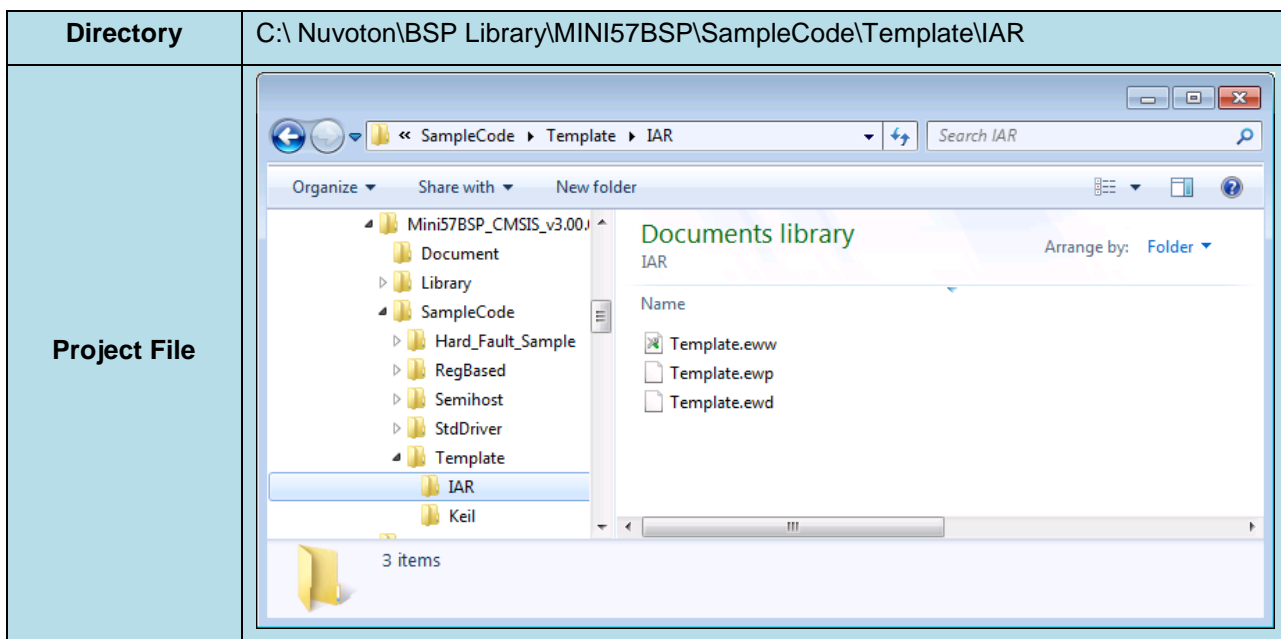







Figure 4-2 Example Directory

This sample code will show some functions about system manager controller and clock controller.

-  Start IAR Embedded Workbench
 - File-Open-Workspace
Open the SYS.eww workspace file
 -  Project - Make
Compile and link the SYS application
-  Project – Download and Debug
Program the application code into on-chip Flash ROM
 -  Single step through code
 -  Reset the device
 -  Run the application

5 STARTING TO USE NU-LINK-ME 3.0 VCOM FUNCTION

5.1 Downloading and Installing VCOM Driver

Please connect to Nuvoton NuMicro® website (<http://www.nuvoton.com/NuMicro>) to download the “NuMicro® ICP Programming Tool” file. After the ICP Programming Tool driver is downloaded, please unzip the file and execute the “ICP Programming Tool.exe”. Simply follow the installation and optional steps to install ICP Programming Tool and Nu-Link USB Driver, which included VCOM driver.

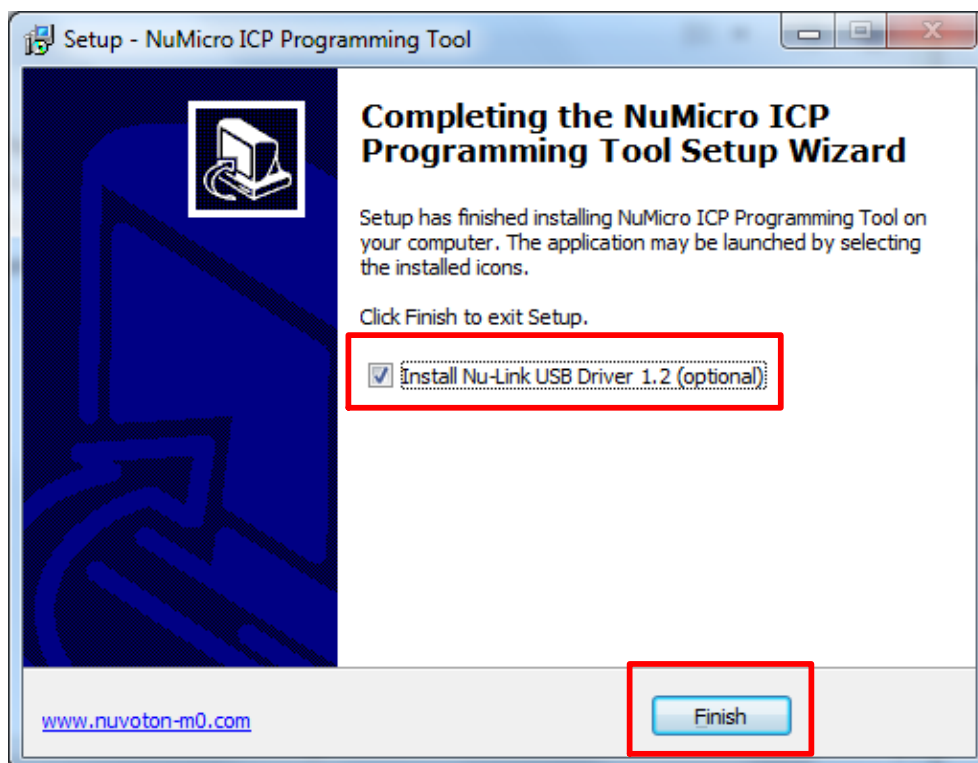

Figure 5-1 Optional Step after ICP Programming Tool Installation

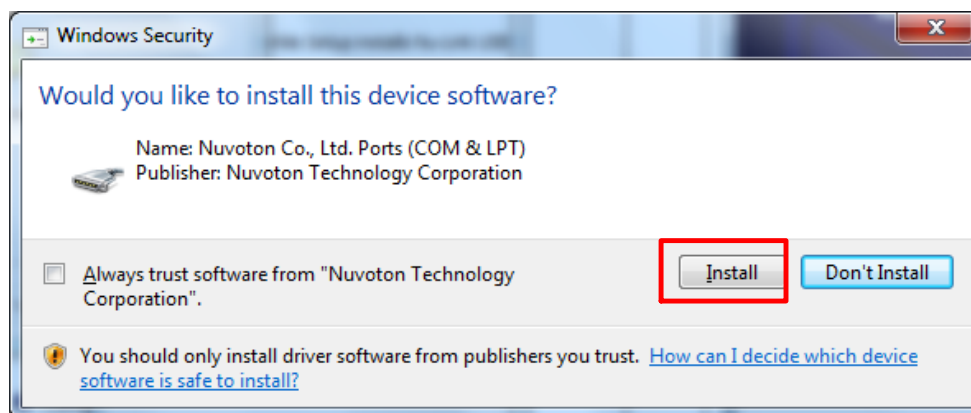

Figure 5-2 Install Nuvoton COM&LPT Driver

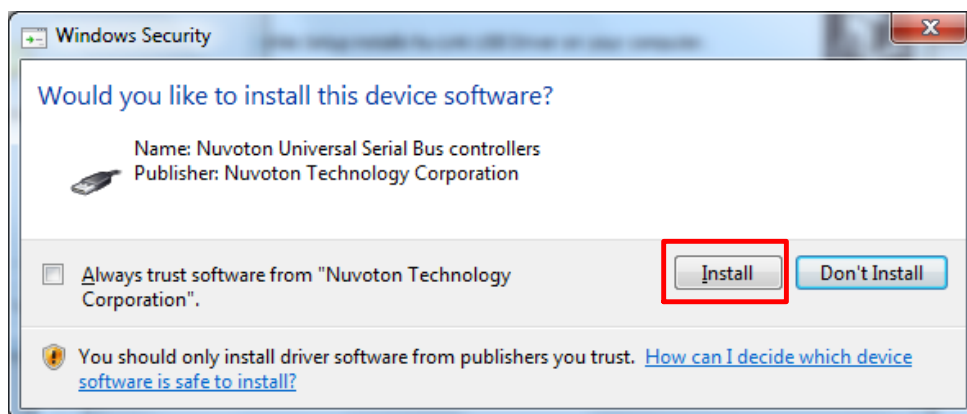

Figure 5-3 Install Nuvoton Universal Serial Bus Controllers

5.2 VCOM Mode Setting on NuTiny-SDK-MINI57

Before the NuTiny-SDK-MINI57 is connected to the PC, please enable SW3 VCOM function by switching on SW3. The NuTiny-EVB-MINI57 transmits through UART0 to VCOM to send out data. Switch SW3 off when using UART0 function without VCOM function.

5.3 Development Tool Setup

The example is demonstrated on the Keil μ Vision[®] IDE.

5.3.1 Check the Using UART on the Keil μ Vision[®] IDE

Please open the project and find system_Mini57Series.h to check the using UART in DEBUG_PORT, which has to be the same as the using UART in the NuTiny-EVB-MINI57.

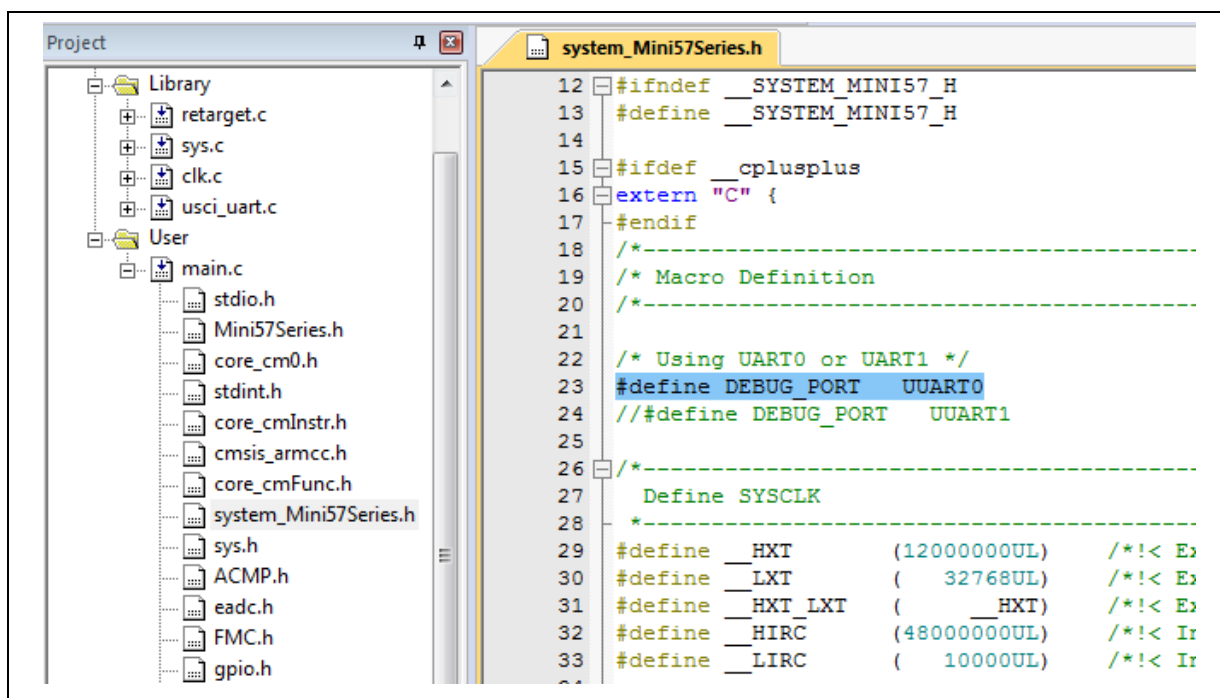
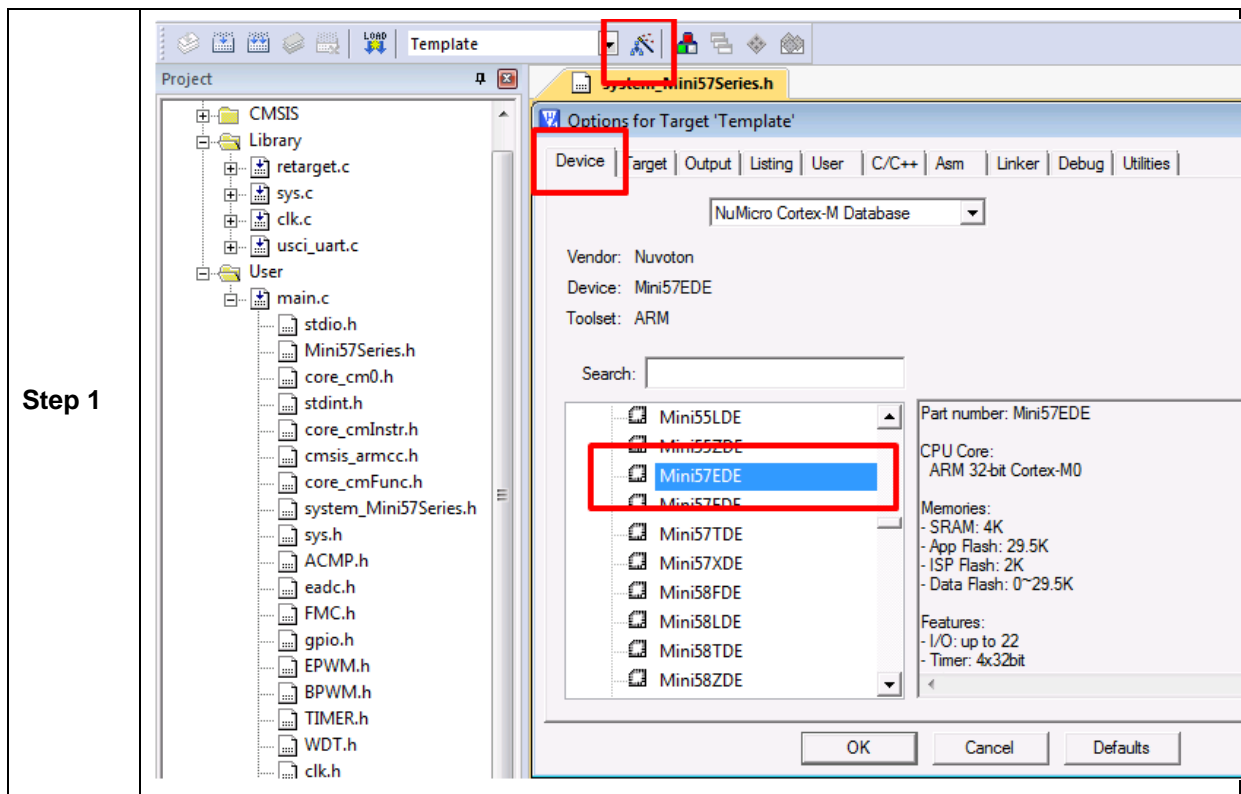

Figure 5-4 Using UART on Keil μ Vision[®] IDE

5.3.2 Check the Target Device and Debug Setting

The target device has to be the same as the setting in Debug. Please click “Target Option” to open the Option windows, and find the setting in “Device”, “Debug”, and “Utilities” page. Please follow the steps below to check the setting.



Step 1

Step 2

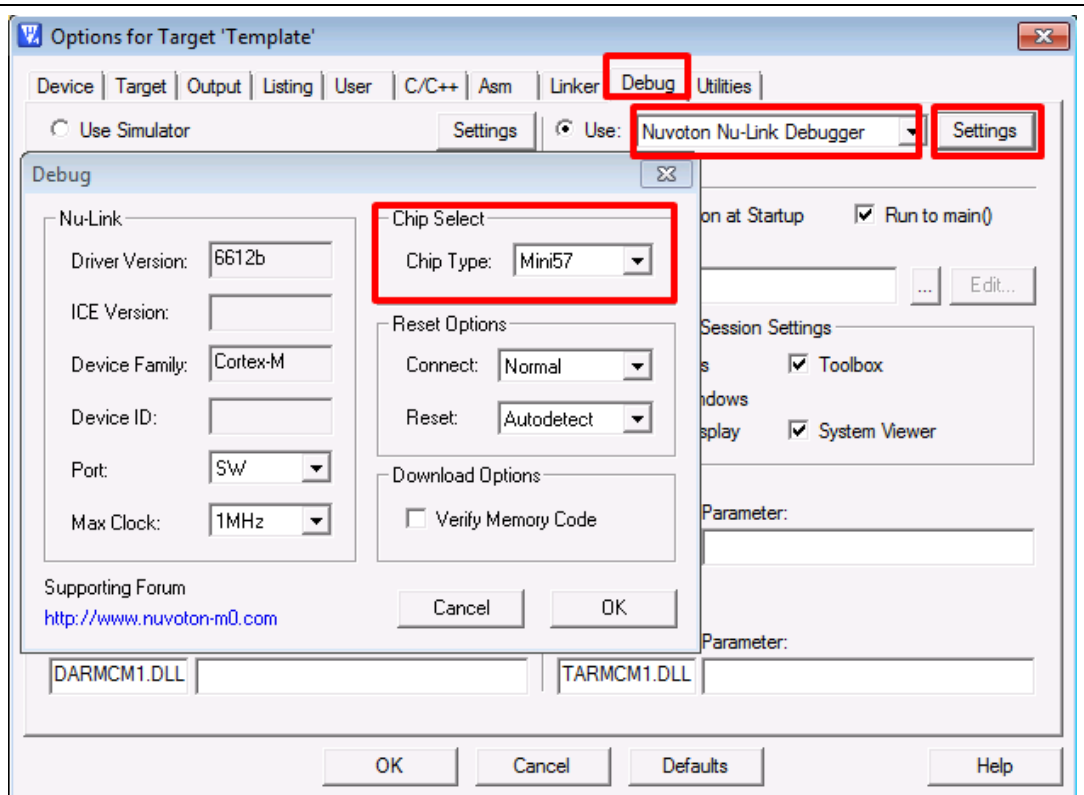

Step 3

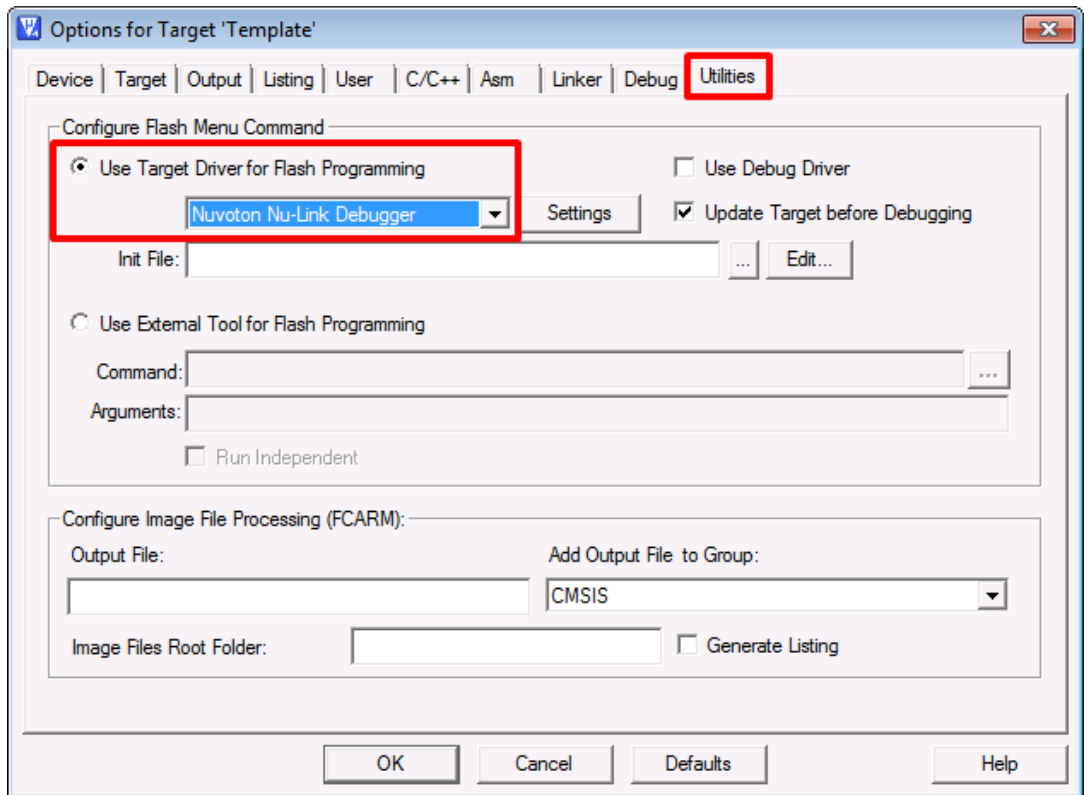

5.3.3 Build and Download Code to NuTiny-SDK-MINI57

Please build the project and download code to the NuTiny-SDK-MINI57.

5.3.4 Open the Serial Port Terminal

User can use serial port terminal, PuTTY for example, to print out debug message.

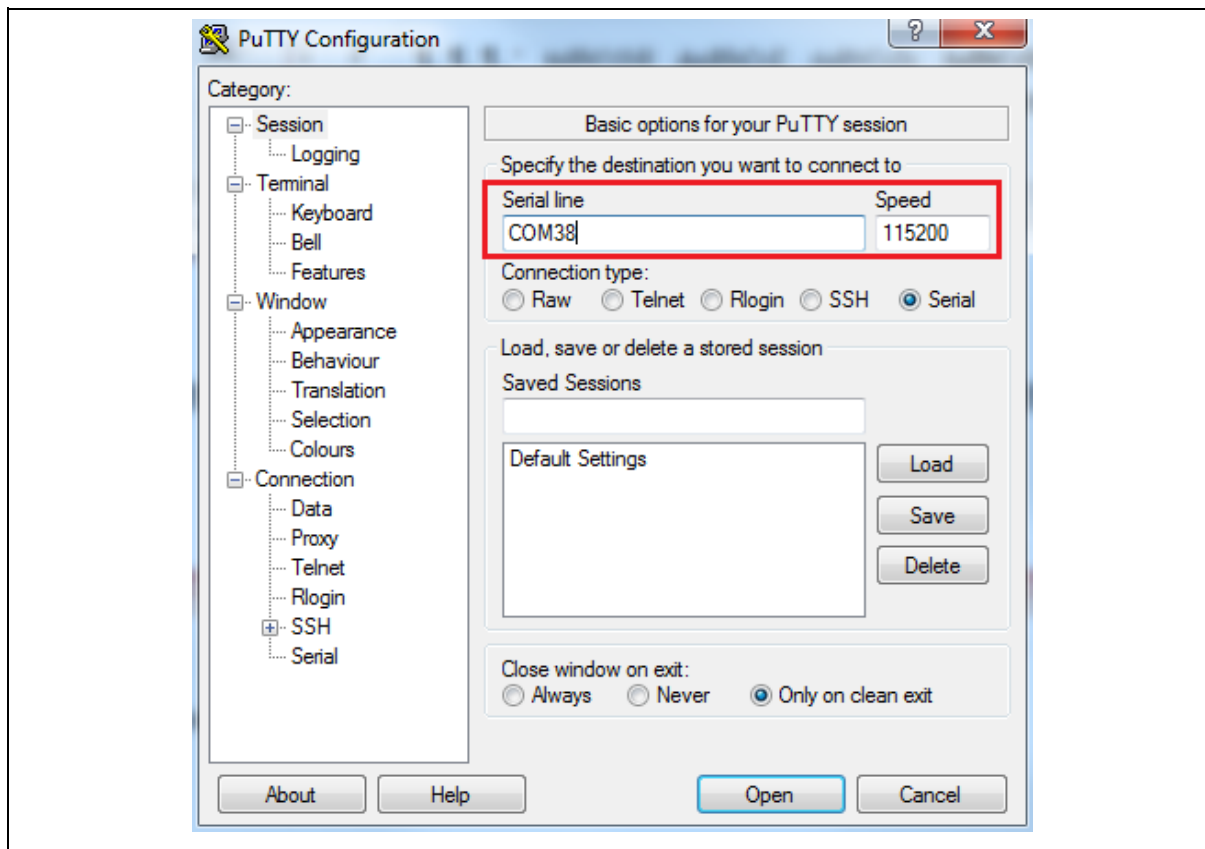

Figure 5-5 Set Baud Rate

5.3.5 Reset Chip

After pushing the reset button, the chip will reprogram application and print out debug message.

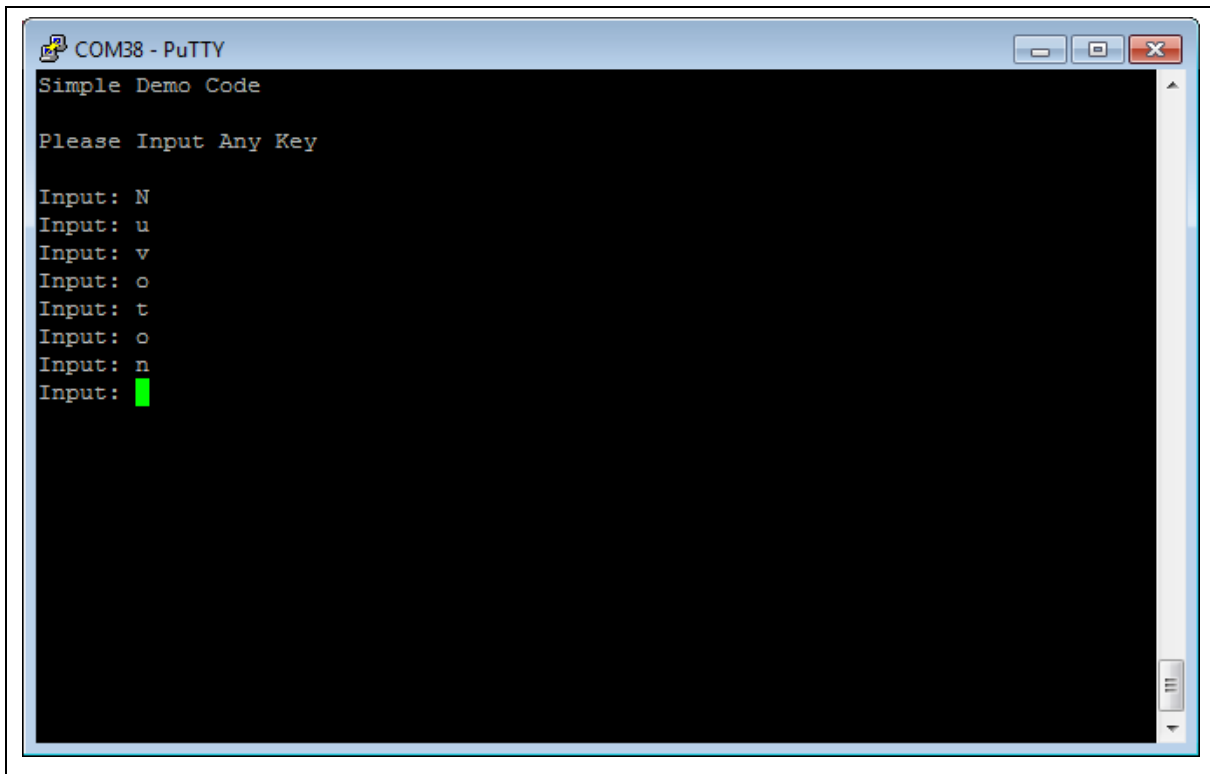
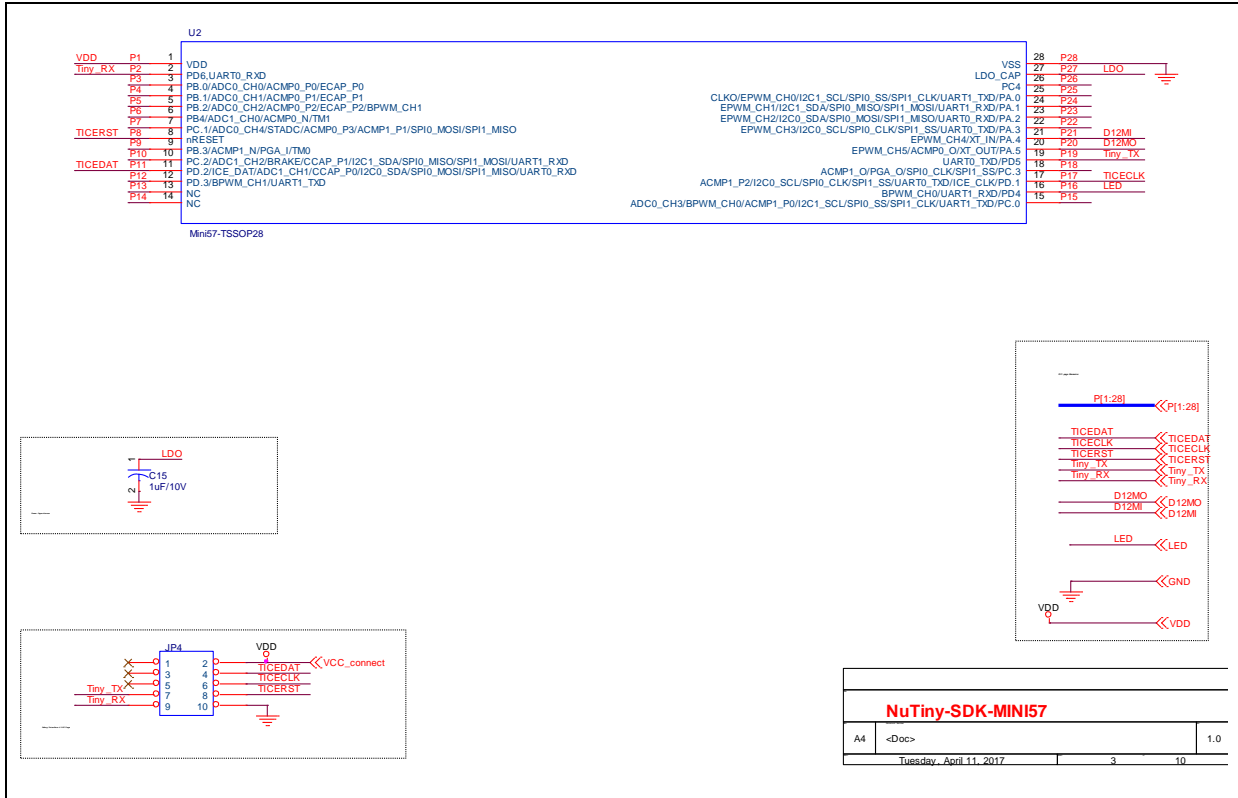

Figure 5-6 Serial Port Terminal Windows

Note: Please switch SW3 on before the NuTiny-SDK-MINI57 is connected to the PC. When the NuTiny-SDK-MINI57 is connected to the PC with SW3 switch on, PC will detect VCOM as a USB device and the detection will only be processed once. VCOM will not function if SW3 switched on after the connection.

6 NUTINY-SDK-MINI57 SCHEMATICS

6.1 NuTiny-EVB-MINI57 Schematic



6.2 GPIO for 28 pin Schematic

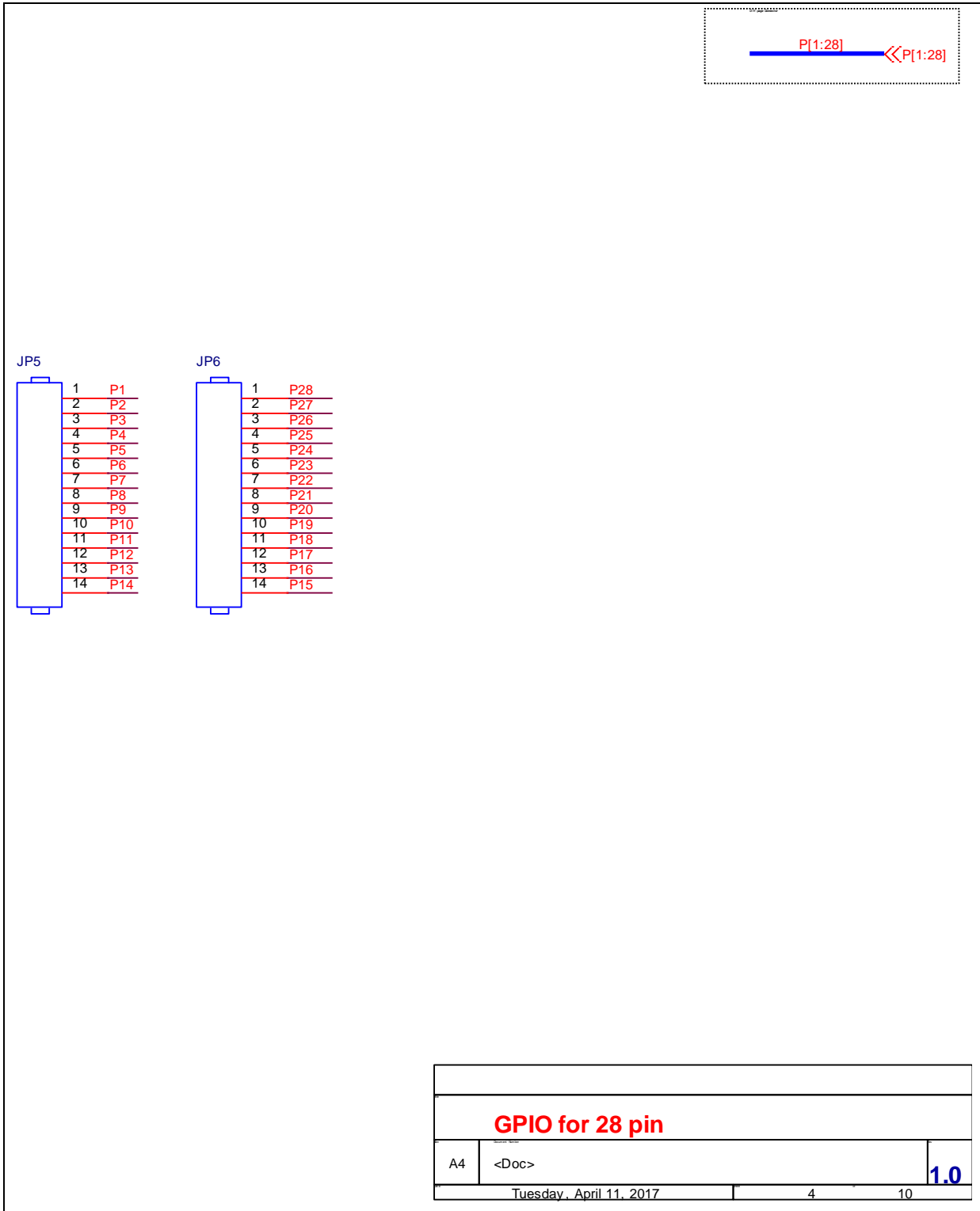

6.3 SDK Circuit Schematic

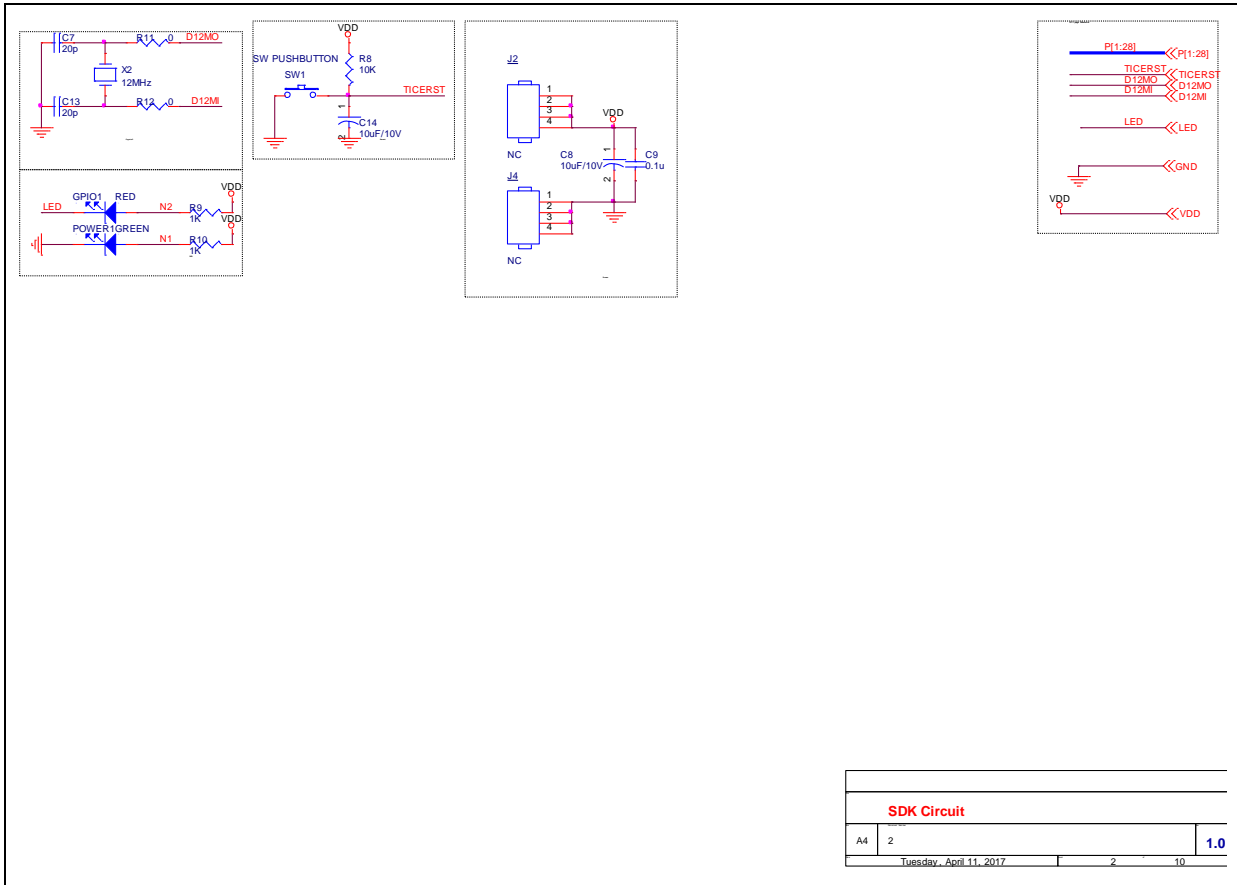

6.4 Nu-Link-Me V3.0 Schematic

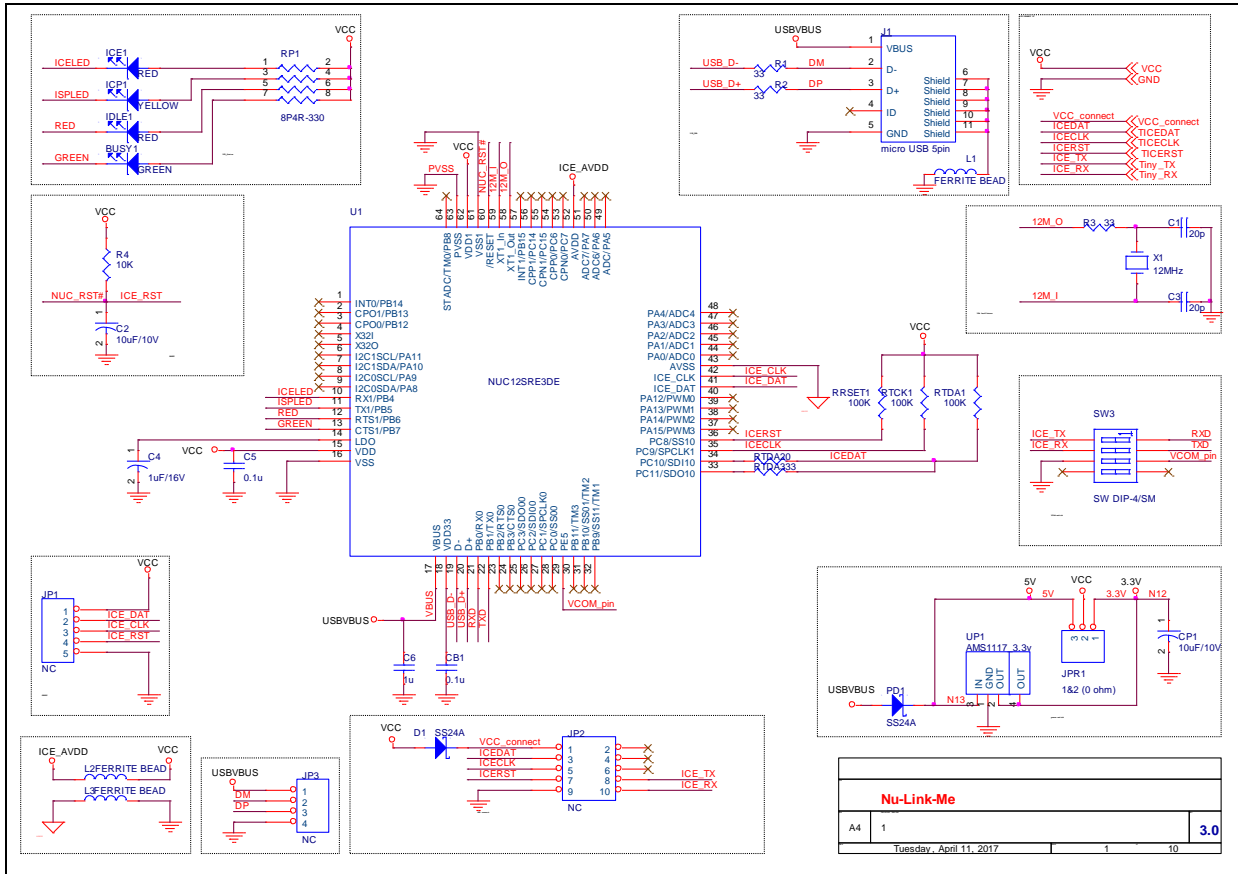

7 REVISION HISTORY

Date	Revision	Description
2017.04.06	1.00	1. Initially issued.

Important Notice

Nuvoton Products are neither intended nor warranted for usage in systems or equipment, any malfunction or failure of which may cause loss of human life, bodily injury or severe property damage. Such applications are deemed, "Insecure Usage".

Insecure usage includes, but is not limited to: equipment for surgical implementation, atomic energy control instruments, airplane or spaceship instruments, the control or operation of dynamic, brake or safety systems designed for vehicular use, traffic signal instruments, all types of safety devices, and other applications intended to support or sustain life.

All Insecure Usage shall be made at customer's risk, and in the event that third parties lay claims to Nuvoton as a result of customer's Insecure Usage, customer shall indemnify the damages and liabilities thus incurred by Nuvoton.

*Please note that all data and specifications are subject to change without notice.
All the trademarks of products and companies mentioned in this datasheet belong to their respective owners.*