

A-A(20:1)

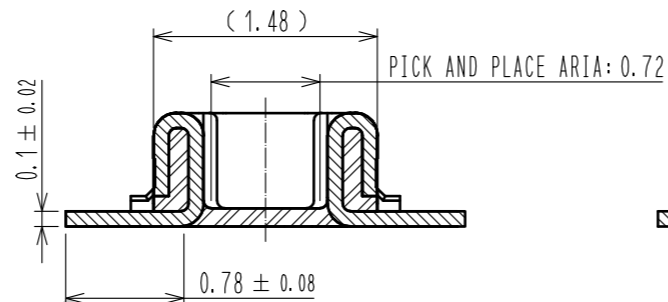

B-B(20:1)

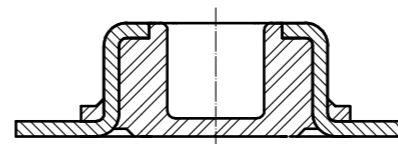

C-C(20:1)

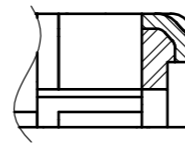

ENGAGEMENT FIGURE (20:1)

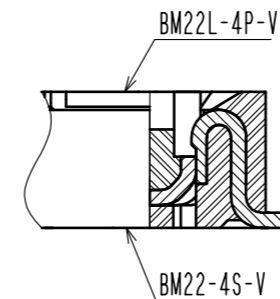
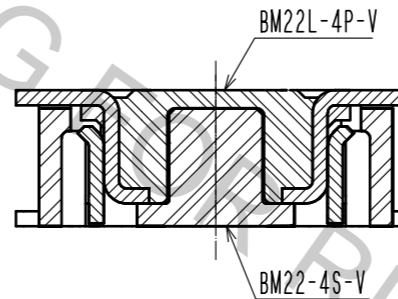
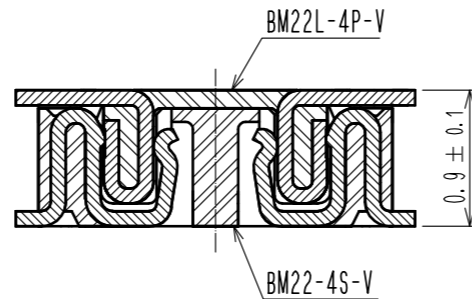

4 RECOMMENDED REFLOW TEMPERATURE PROFILE USING LEAD-FREE SOLDER PASTE.

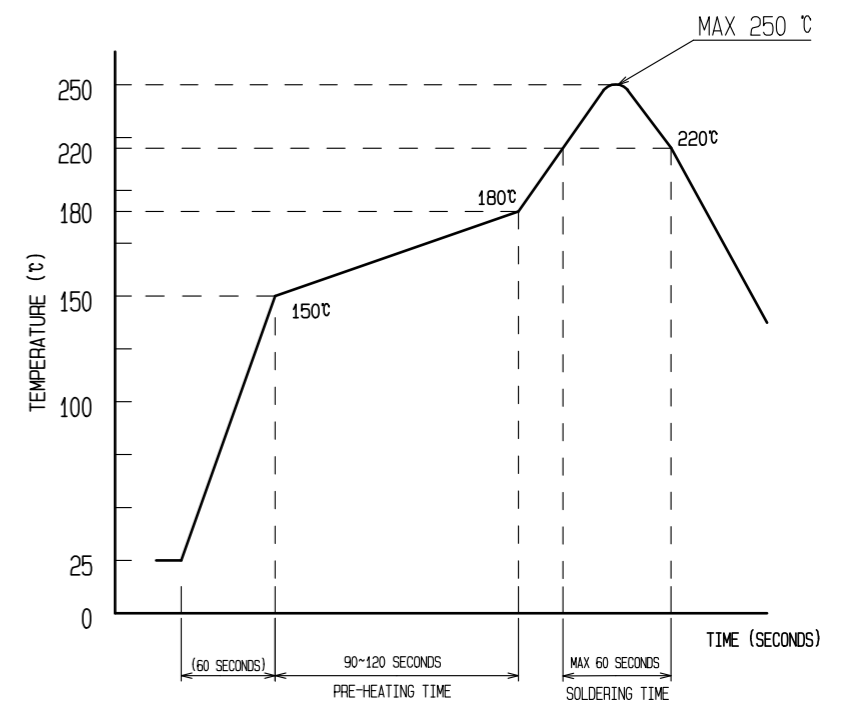

REFLOW METHOD: IR REFLOW
 NUMBER OF REFLOW CYCLES: 2 CYCLES MAX.
 1) REFLOW TIME
 DURATION ABOVE 220°C, 60 SEC MAX.
 (PEAK TEMPERATURE: 250°C MAX)
 2) PRE-HEAT TIME
 PRE-HEAT TEMPERATURE (MIN): 150°C
 PRE-HEAT TEMPERATURE (MAX): 180°C
 PRE-HEAT TIME: 90-120 SEC.

4 THIS TEMPERATURE PROFILE IS PER THE CONDITIONS SHOWN ABOVE. ADDITIONAL FACTORS, SUCH AS SOLDER PASTE TYPE, PCB SIZE AND OTHER MOUNTED COMPONENTS COULD AFFECT THE PROFILE. THEREFORE, A THOROUGH EVALUATION OF MOUNTING COONDITION IS REQUIRED PRIOR TO PRODUCTION. TEPEERATURE IS MEASURED AT CONTACT LEAD.

- NOTE 1. ALL LEAD CO-PLANARITY SHALL BE 0.08mm MAX
- 2 CONTACT PLATING SPECIFICATIONS
 CONTACT AREA : GOLD 0.05 μm MIN
 SMT LEAD : GOLD 0.01 μm MIN
 UNDER PLATING : NICKEL 1 μm MIN
 (SURFACE : SEALING)
- 3 HRS MARK AND CAV No. ARE INDICATED IN APPROX POSITION SHOWN.

◆ RECOMMENDED PCB LAYOUT(5:1)

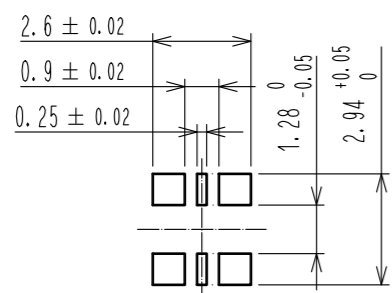

◆ RECOMMENDED METAL MASK DIMENSIONS(5:1)

METAL MASK THICKNESS : 100 μm

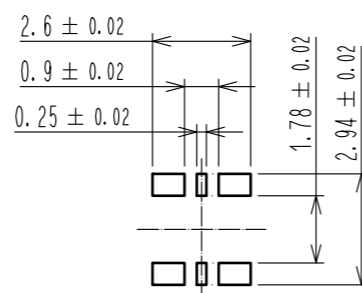

NO.	MATERIAL	FINISH . REMARKS	NO.	MATERIAL	FINISH . REMARKS
4	PS	CLEAR (EMBOSSD CARRIER TAPE)	7	PS	CLEAR (REINFORCEMENT COLLAR)
3	COPPER ALLOY	2	6	PS	BLACK (PLASTIC REEL)
2	COPPER ALLOY	2	5	POLYESTER	CLEAR (COVER TAPE)
1	LCP	UL94 V-0, BLACK			

UNITS	SCALE	COUNT	DESCRIPTION OF REVISIONS	DESIGNED	CHECKED	DATE
mm	10 : 1	1	DIS-H-0000053	NY. YAMASHIRO	TS. MIYAZAKI	15. 01. 27

APPROVED	CHECKED	DESIGNED	DRAWN	DRAWING NO.	PART NO.	CODE NO.
MO. ISHIDA	TS. MIYAZAKI	NY. YAMASHIRO	KR. AJITO	EDC-354825-53-04	BM22L-4P-V(53)	CL677-1006-7-53

EMBOSSED CARRIER TAPE PACKAGING

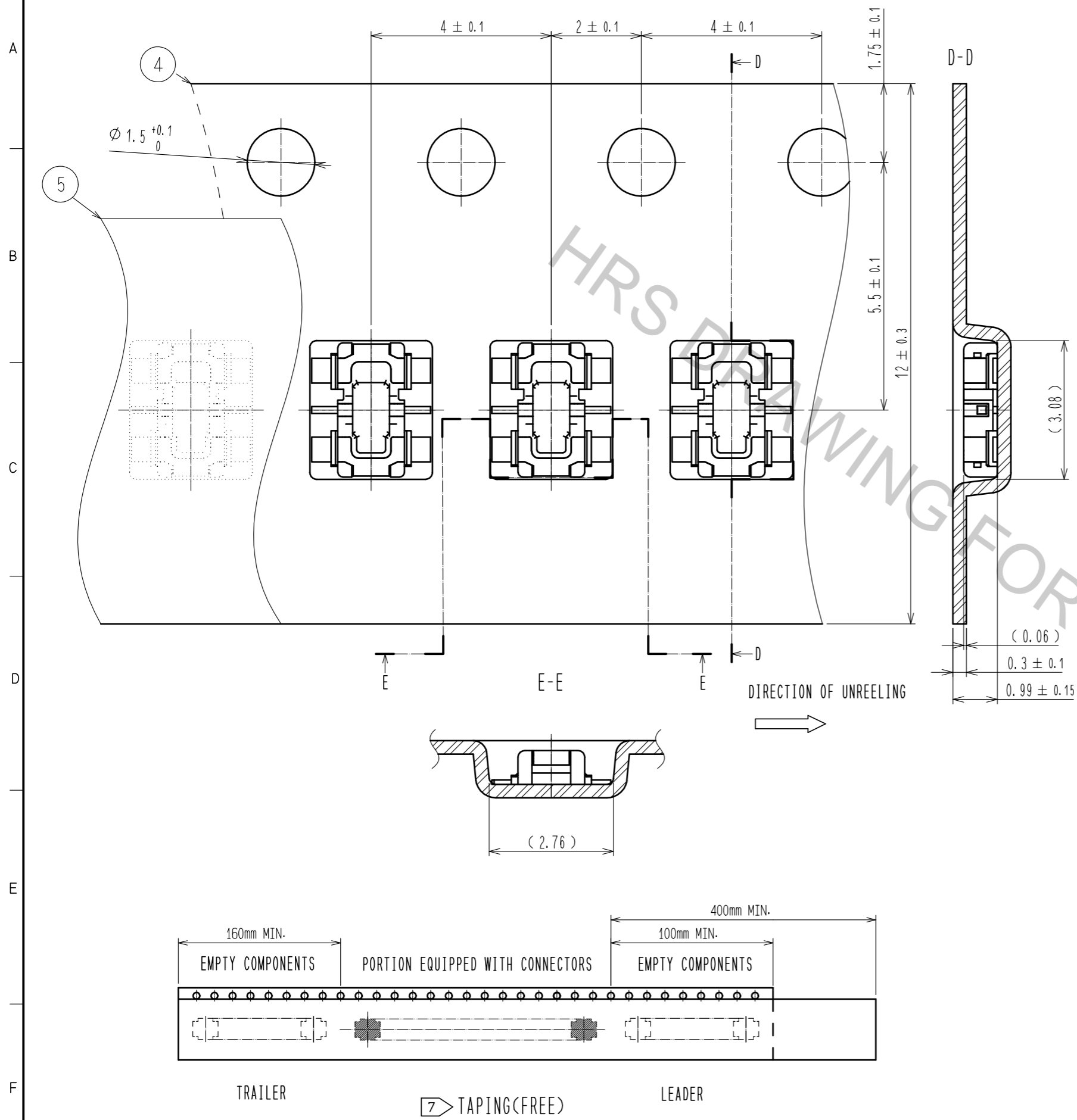

STYLE AND DIMENTION OF REEL (FREE)

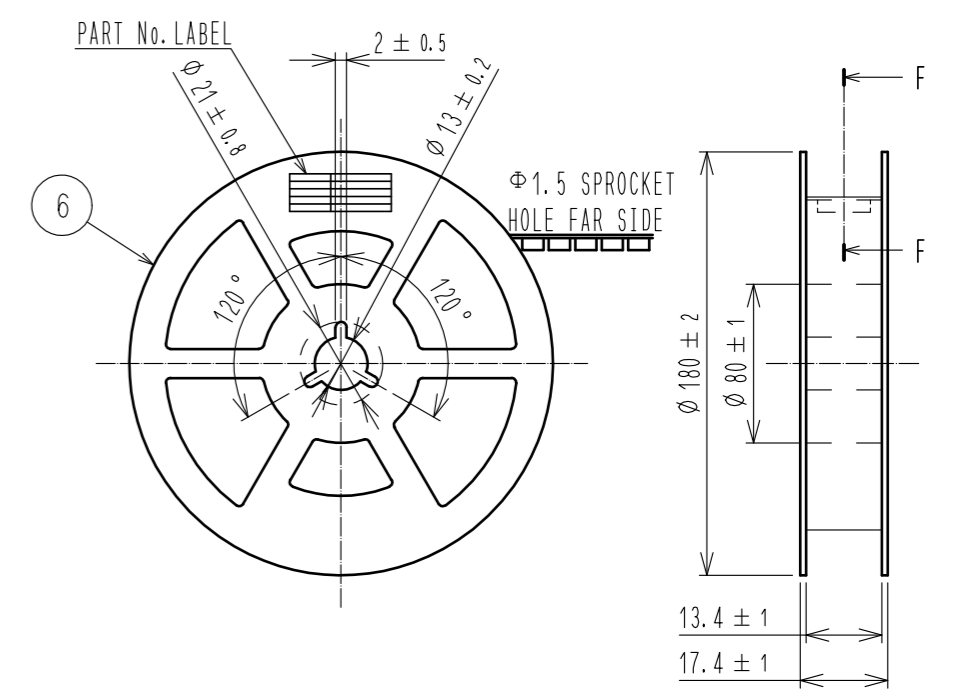

F-F (FREE)

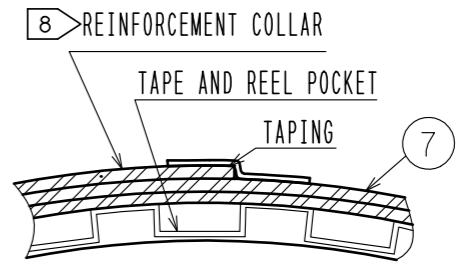

DETAIL OF PART No. LABEL

製造年月日	** ** *	DATE OF MANUFACTURED
製品コード	CL0677-1006-7-53	CODE No.
製品名	BM22L-4P-V(53)	PART No.
数量	1,000	QUANTITY
納入者	ヒロセ電機(株)	SUPPLIER

- 5. PER REEL 1,000 CONNECTORS.
- 6. THE DIMENTIONS IN PARENTHESSES ARE FOR REFERENCE.
- 7. REFER TO JIS C 0806-3(IEC 60286-3)(PACKAGING OF COMPONENTS FOR AUTOMATIC HANDLING)
- 8. AFTER PACKAGING, ROLL 2 METERS OF THE REINFORCEMENT COLLAR TO OUTER CIRCUMFERENCE OF TAPE AND REEL POCKET. AND TAPE DOWN AT THE END THE COLLAR.

HRS	DRAWING NO.	EDC-354825-53-04
	PART NO.	BM22L-4P-V(53)
	CODE NO.	CL677-1006-7-53

How to draw the FPC

BM22 series connector is intended to carry 3A to 4A electrical current for battery application. FPC may have less flexibility than usual, since the copper foil becomes wider and thicker to carry current of 3A.

Please design the FPC to have a flexibility to absorb the displacement* of the connector case by fixing PCB and battery.

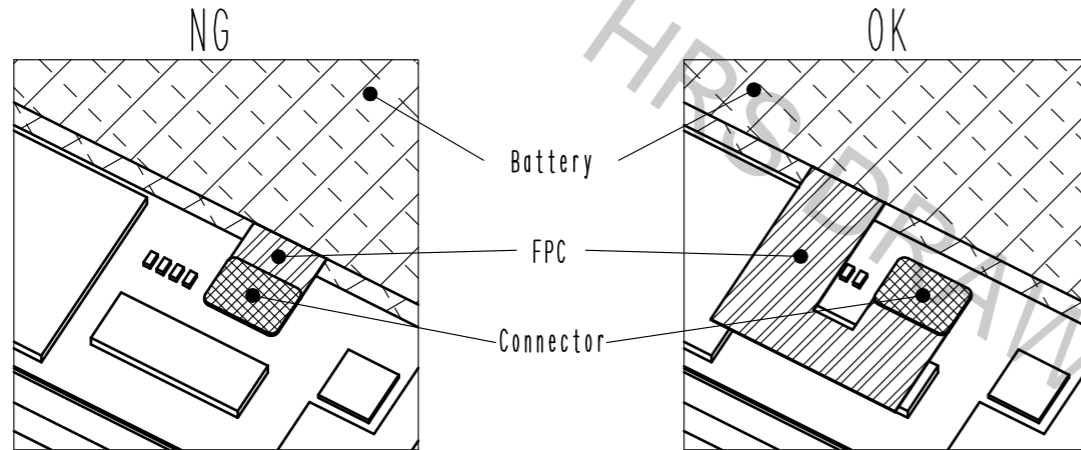

*Possible problems caused by connector mating in incorrect positioning.
Mating the connector in incorrect positioning could lose the function of the connector.

① Insulator could be broken.

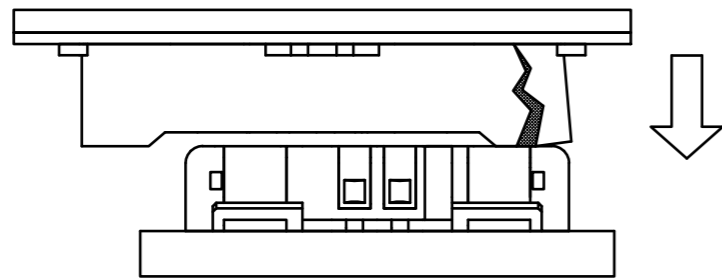

② It could apply excessive mechanical stress to single side of the contact.

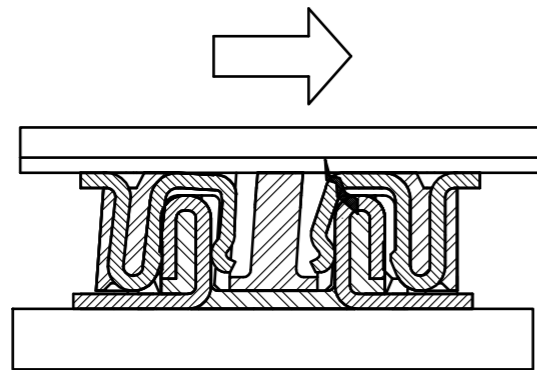

Electric shock hazard

Since power contact of header side is exposed, the battery may short out if you touch the contact with finger during mating operation. To avoid this accident, mounting a header on main PWB and mounting a receptacle on battery side is recommended.

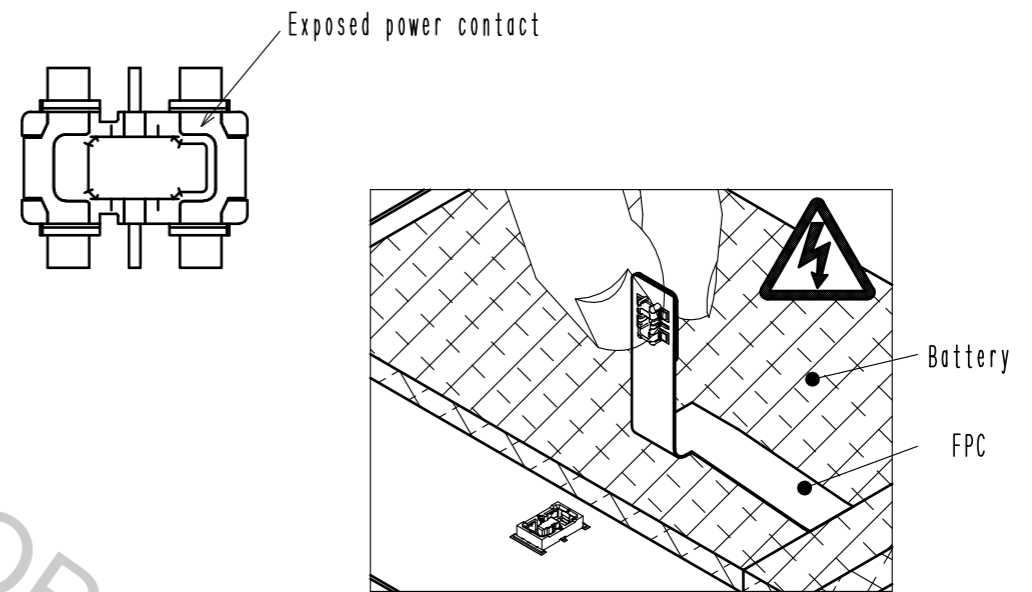

HRS	DRAWING NO.	EDC-354825-53-04	3/3
	PART NO.	BM22L-4P-V(53)	
	CODE NO.	CL677-1006-7-53	