

RECEIVER-612-2-SC

2403 260 00051

Contents

1. Theory of operation.....	3
2. Mechanical Layout and Dimensions.....	4
2.1. Main Dimensions.....	4
2.2. PWB Layout	5
2.3. Spring Force.....	5
2.4. Force on component	6
2.5. Part Marking/Labeling.....	7
2.6. Material List.....	8
3. Electrical and Acoustical Specifications.....	9
3.1. Frequency response	9
3.2. Electro-Acoustic Parameters	10
3.3. Power handling.....	10
3.4. Measurement setup	11
3.5. Measured Parameters.....	11
3.6. Measurement adapter	12
4. Environmental Conditions.....	13
4.1. Storage.....	13
4.2. Transportation.....	13
4.3. Functionality.....	13
5. Environmental tests	14
5.1. Qualification tests.....	14
5.2. Reliability tests	14
5.3. Sample Size, Sequence	14
5.4. Period of Shelf-Life	14
5.5. Testing Procedures.....	14
6. Related Documents	18
7. Change History	19
8. Disclaimer	19



2403 260 00051

1. Theory of operation

Receiver 612-2-SC is a high end micro size receiver specifically designed for mobile phone and other applications where high quality sound is needed and only very little space for components is available.

2403 260 00051

2. Mechanical Layout and Dimensions

2.1. Main Dimensions

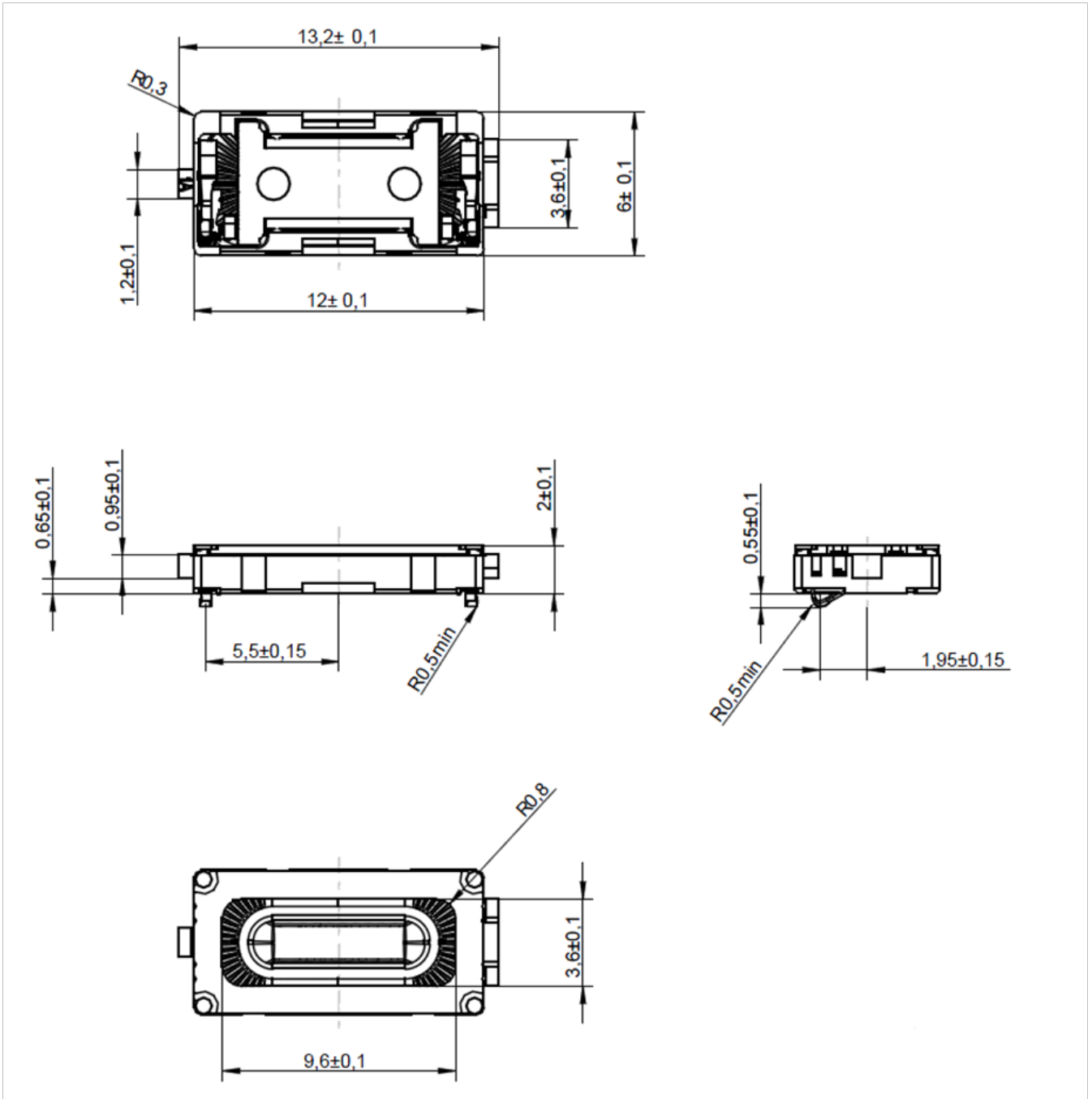

2403 260 00051

2.2. PWB Layout

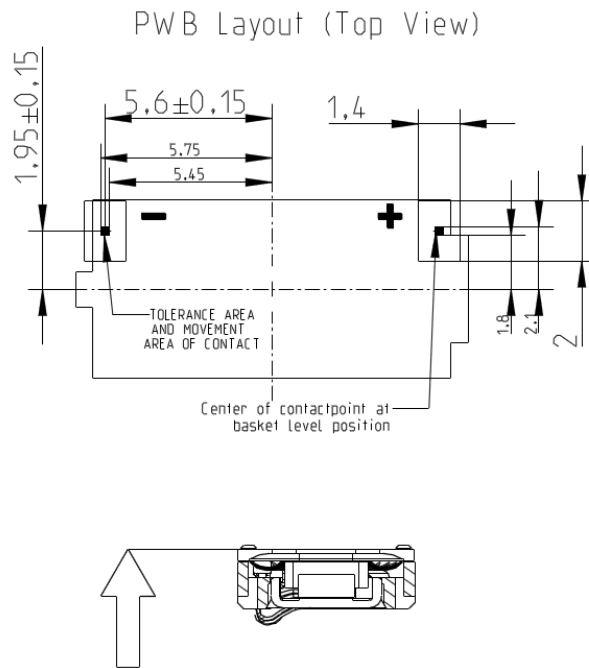

POSITIVE VOLTAGE ON PIN+
MOVES MEMBRANE IN DIRECTION OF ARROW

2.3. Spring Force

RA 6x12x2 springforces

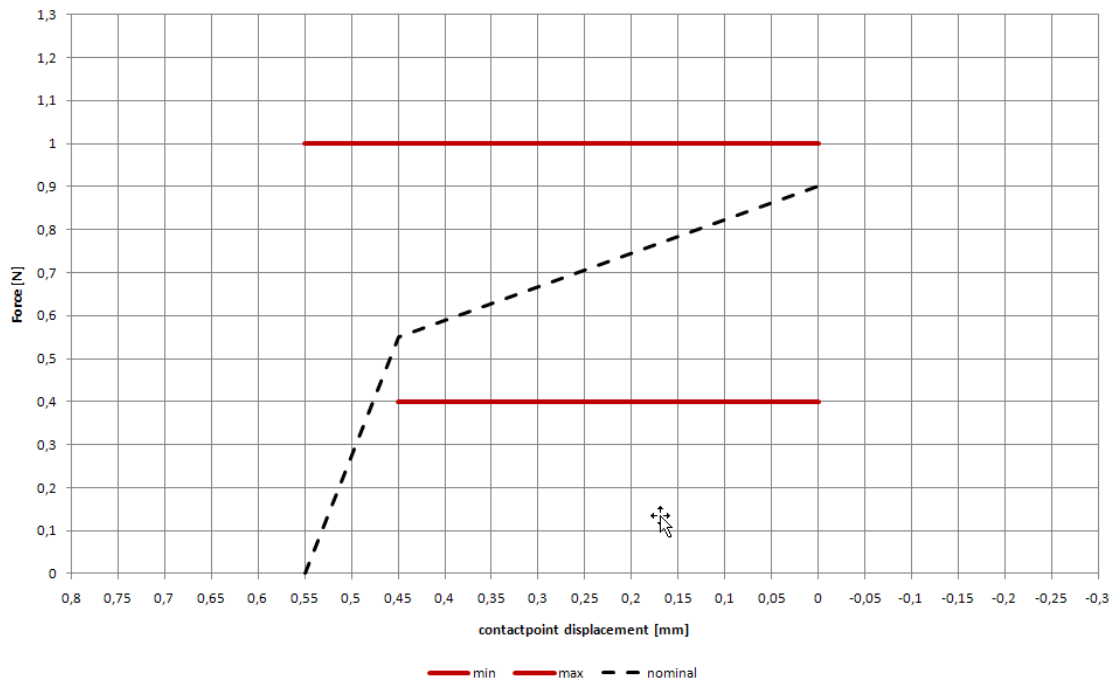

2403 260 00051

2.4. Force on component

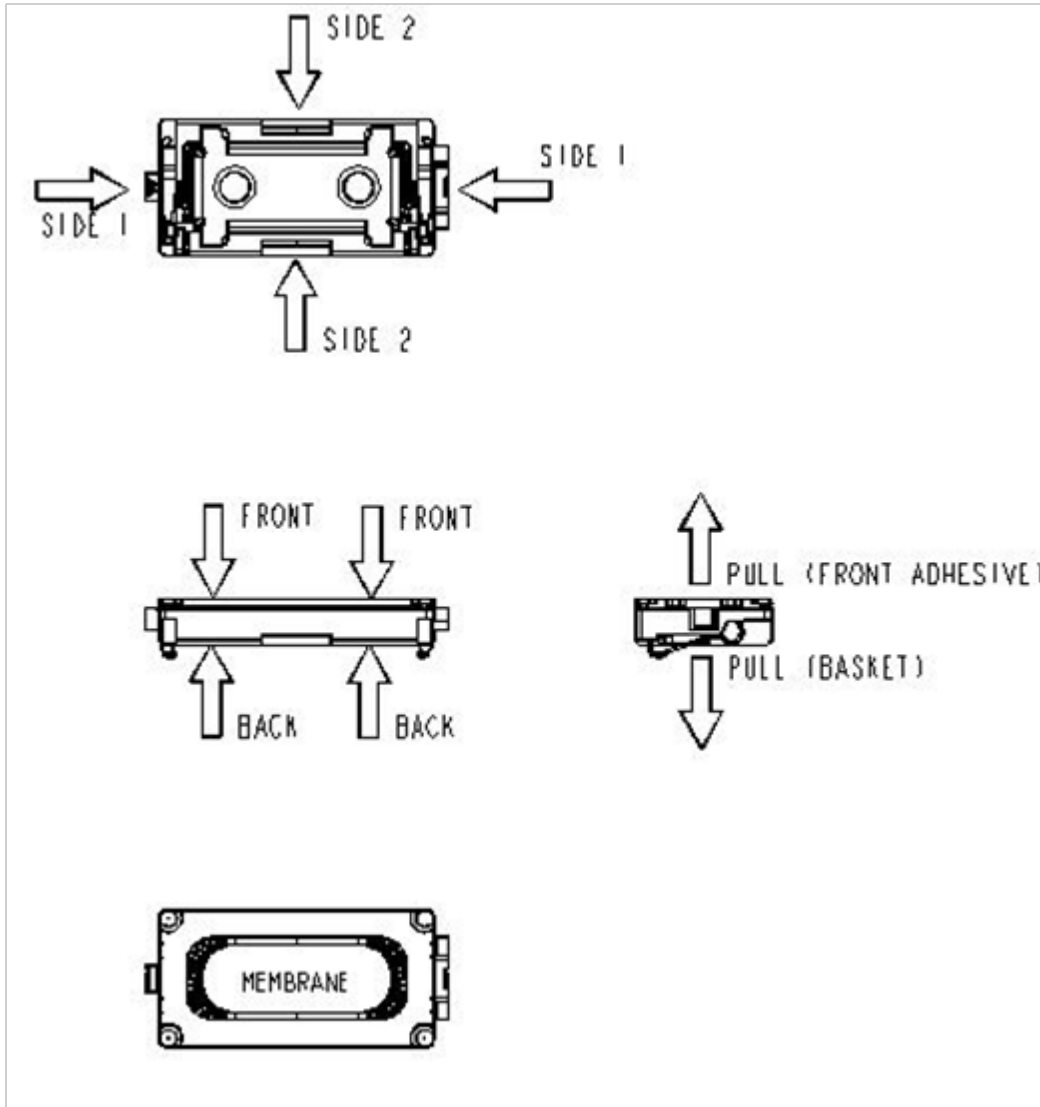

FORCES ON DIFFERENT STATE OF COMPONENT			
STATE	MIN. SURFACE OF PREASURE [mm ²]	MAX PERMANENT FORCE [N]	MAX HANDLING FORCE [N]
FROM FRONT TO BACK	-	10	15
FROM SIDE 1 TO SIDE 1	3	10	15
FROM SIDE 2 TO SIDE 2	10	10	15
POT	-	0	10
MEMBRANE	-	0	0
PULL OF FORCE (Cover)	-	0	5

2403 260 00051

2.5. Part Marking/Labeling

The samples have a serial number on bottom (pot) side

VARIANT A - Laser Printing

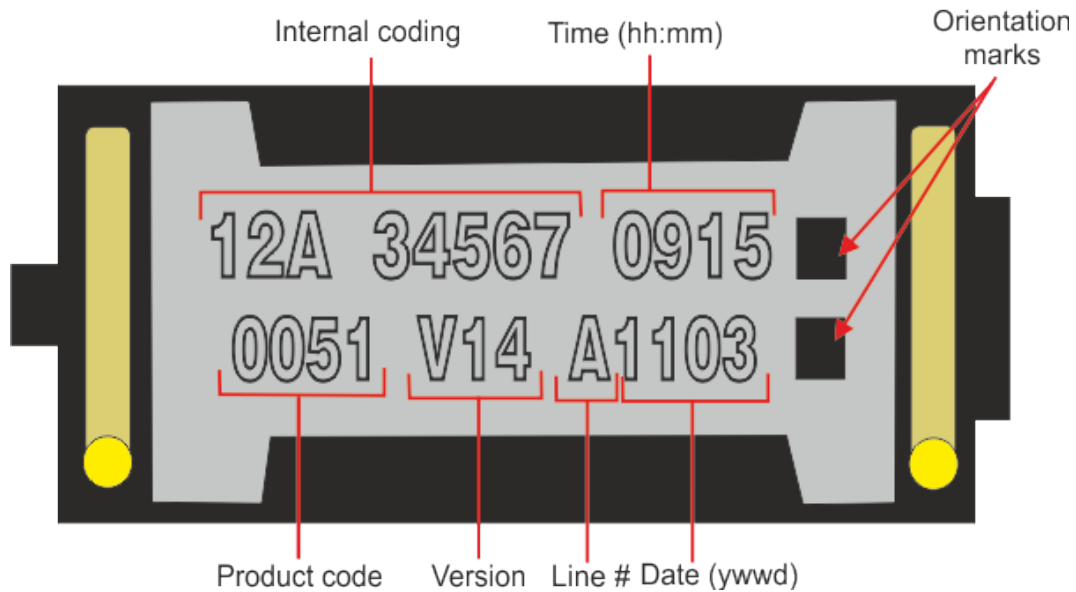

VARIANT B - Inkjet Printing

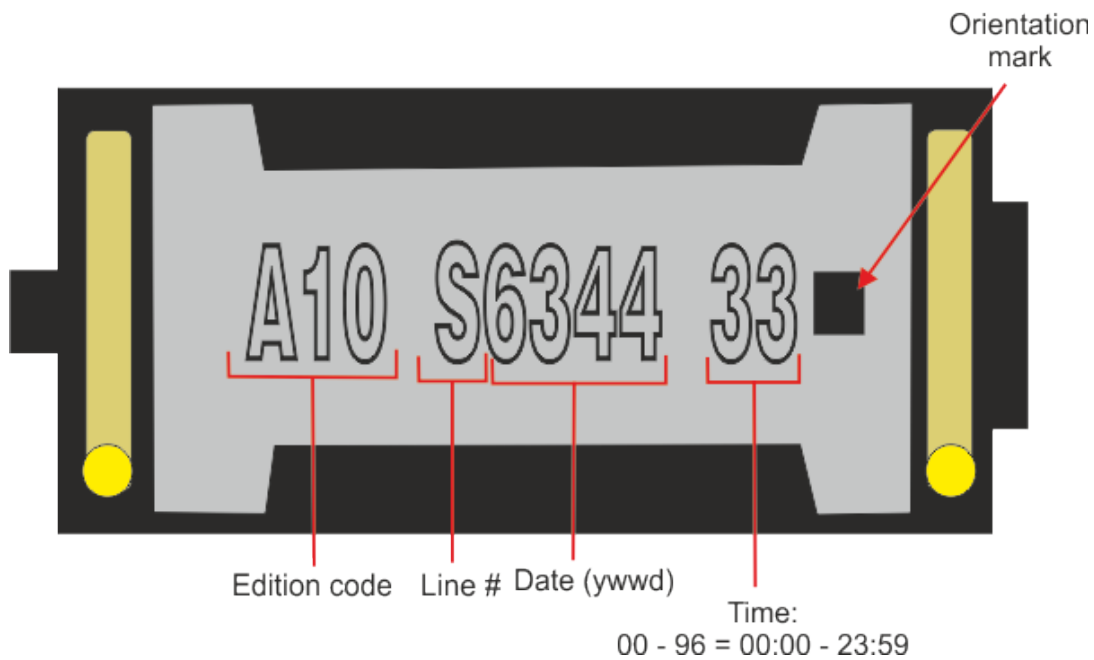

2403 260 00051

2.6. Material List

- | | |
|--------------------------|------------------------------|
| 1. Material of basket: | Polycarbonate (Halogen free) |
| 2. Material of membrane: | Polyarylate-Compound |
| 3. Material of pot: | soft magnetic Iron |
| 4. Material of magnet: | Nd Fe B |
| 5. Material of contact | CrNi Steel gold plated |
| 6. Material of cover: | Brass |
| 7. Dimensions: | 6x12x2 mm |
| 8. Mass: | 0,35 g |

2403 260 00051

3. Electrical and Acoustical Specifications

3.1. Frequency response

Typical frequency response measured on baffle according to chapter 2.4
(distance $d = 1\text{cm}$, $p = 10\text{mW}$, without back cavity)

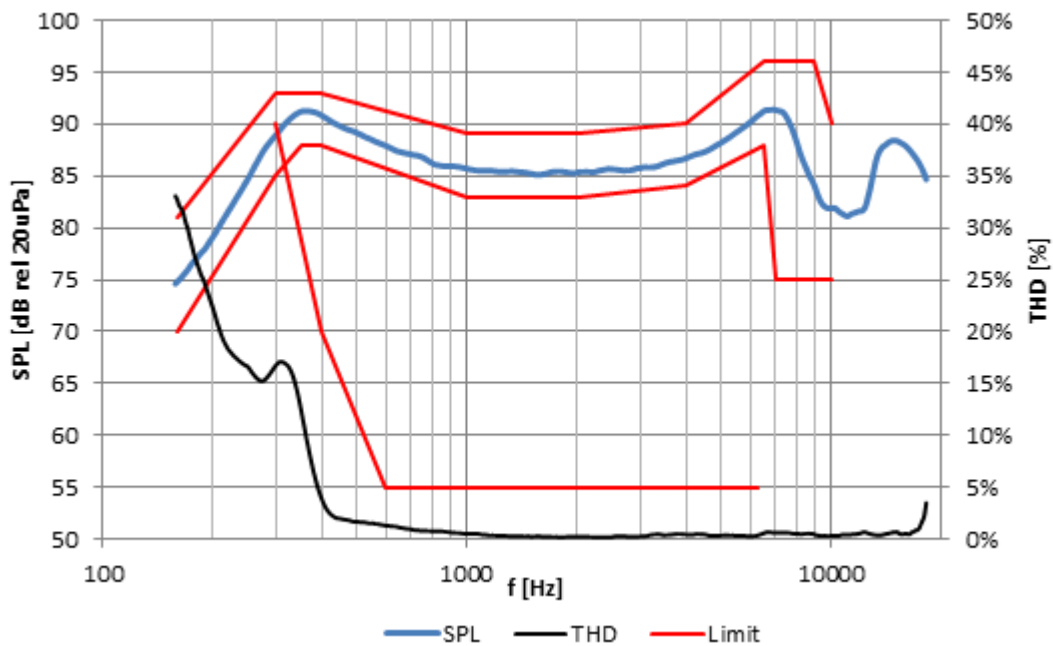

Tolerance window				
f [Hz]	lower limit [dB SPL] (floating)	upper limit [dB SPL] (floating)	f [Hz]	upper limit [%THD]
160	70	80	300	40
300	85	94	400	20
350	88	-	600	5
400	88	94	6300	5
1000	83	87		
2500	83	87		
4000	84	89		
7500	88	96		
8000	75	-		
10000	75	96		

2403 260 00051

3.2. Electro-Acoustic Parameters

Loudspeaker mounted in adapter acc. to 2.6.

1. Rated impedance	Z:	32Ω
2. Voice coil resistance	R:	28.8Ω±10%
3. Resonance frequency (measured @10mW)	f ₀ :	350Hz±15%
4. Maximum usable excursion x _{max}	p-p:	0.6mm p-p
5. Nominal characteristic sensitivity (calculated for 1W in 1m) average from 1kHz to 3kHz		65±2dB
5.1. Measured characteristic sensitivity (at 10mW in 1cm) average from 1kHz to 3kHz		85±2dB
6. THD	according chapter 2.1.	
7. Rub & buzz	< 60dB SPL (300Hz -1500Hz) in 1cm at 10mW (566mV _{eff})	

All acoustic measurements at 23±2°C

3.3. Power handling

Receiver mounted in lifetime test device (open rear/open front)

1. Max short term power		75mW (RMS)
Signal: pink noise HP 2 nd order 800Hz, LP 10 th order 6,3kHz, crest factor 2		
2. Max continuous power	(500h)	10mW (RMS)
Signal: pink noise shaped according to diagram below: HP 10 th order 100Hz, HP 2 nd order 400Hz, LP 10 th order 6,3kHz, crest factor 2		

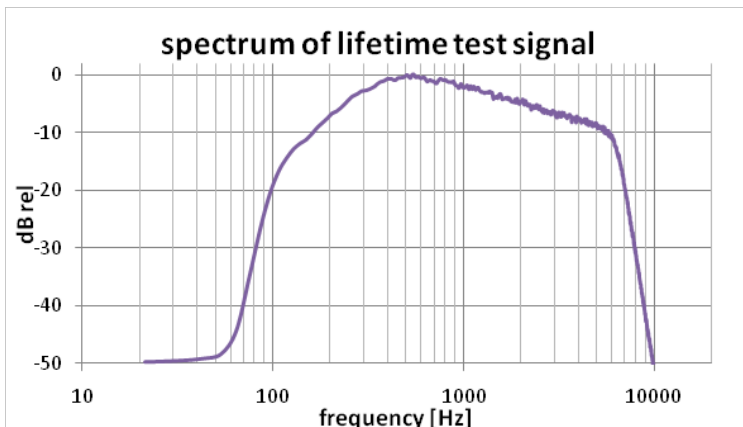

3.4. Measurement setup

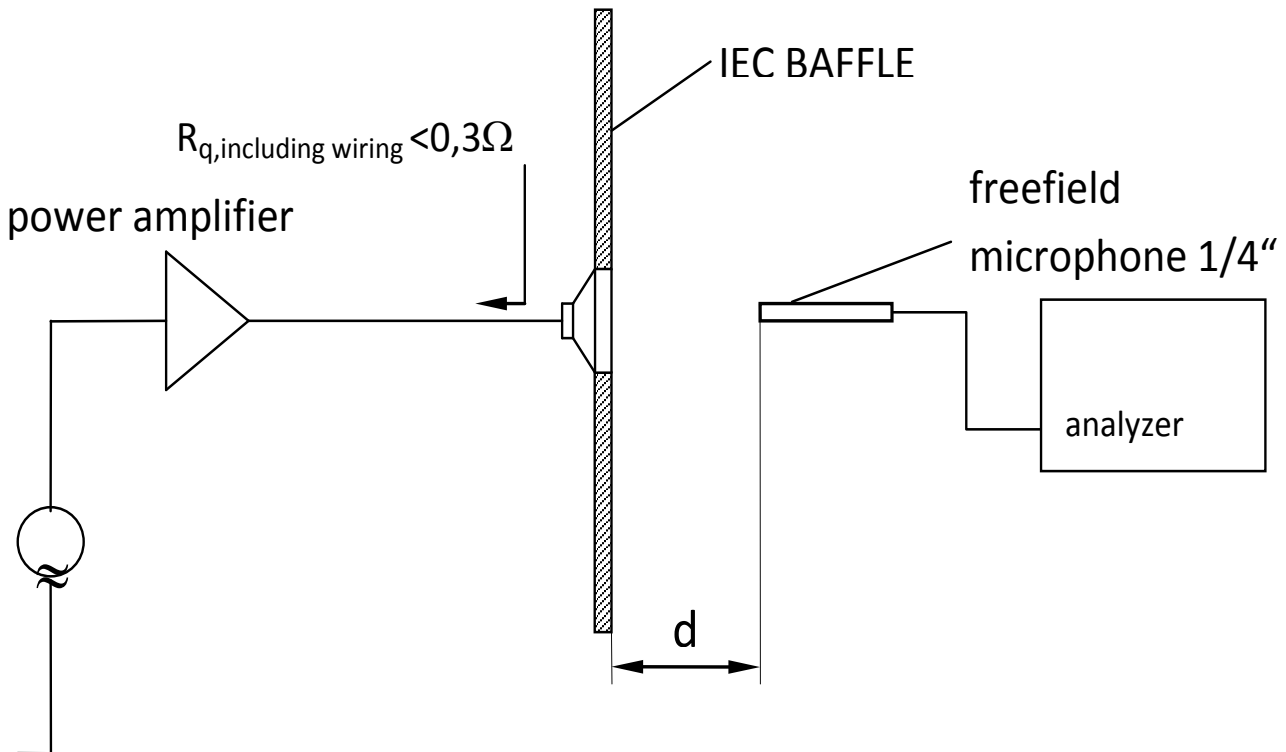

3.5. Measured Parameters

3.5.1. Sensitivity

SPL is expressed in dB rel $20\mu\text{Pa}$, computed according to IEC 268-5. Measurement set up and parameters according chapter 3.4. This test is performed for 100% of products in the production line.

3.5.2. Frequency response

Frequency response is measured according test set up in chapter 3.4 data sheet and checked against the tolerance window defined in chapter 3.1. This Test is performed for 100% of products in the production line.

3.5.3. Total harmonic distortion (THD)

Is measured according IEC 268-5 (2nd to 5th harmonics) and test set up in chapter 3.4. This test is performed for 100% of products in the production line.

3.5.4. Rub& Buzz

Rub & Buzz will be measured in the Inline-measuring device with a sinusoidal sweep. Rub & Buzz is defined as the maximum level of no harmonic energy, expressed as signal to non-harmonic content ratio, in a certain frequency-range. Signal and evaluation criteria are according to chapter 3.2. This test is performed for 100% of products in the production line.

2403 260 00051

3.6. Measurement adapter

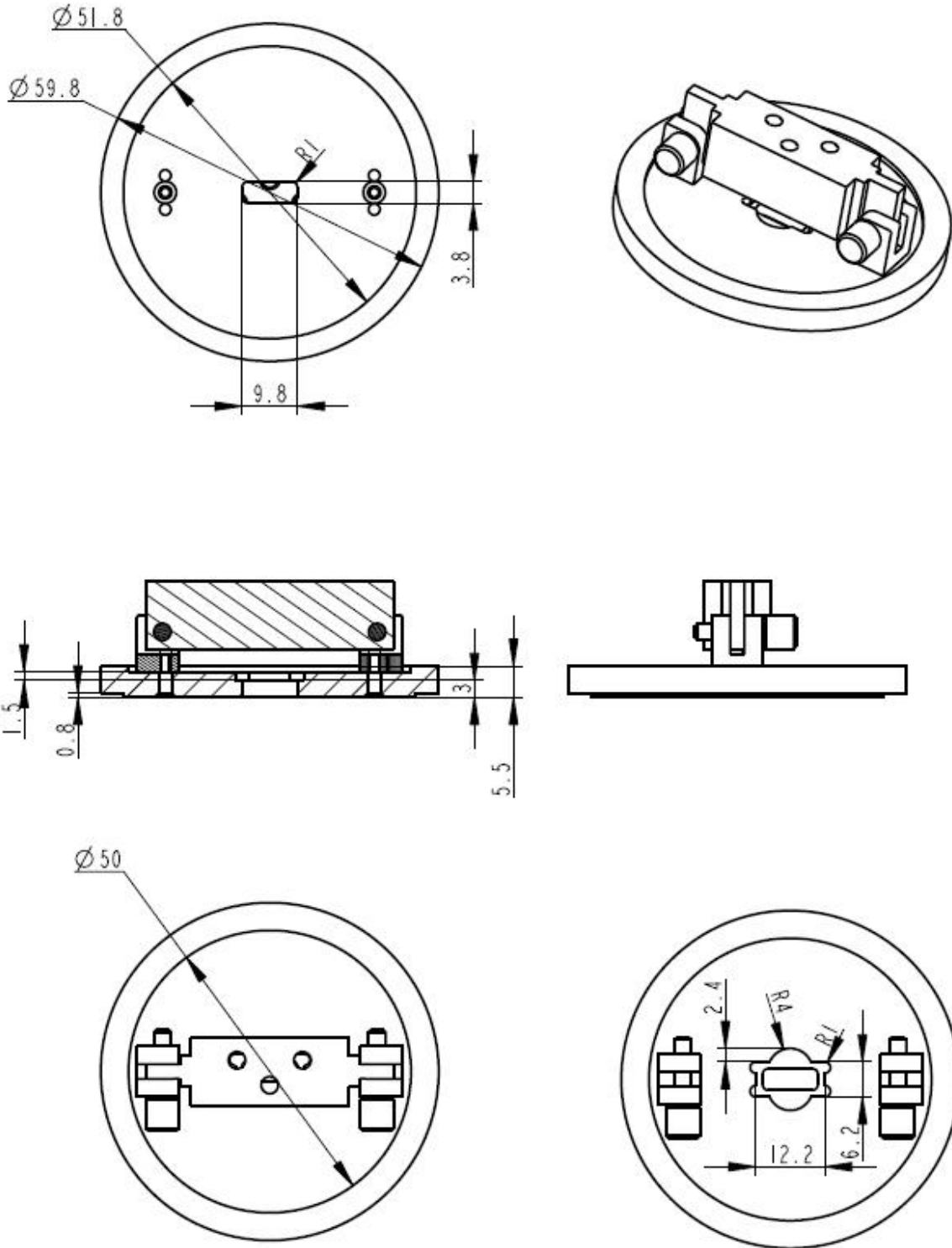

2403 260 00051

4. Environmental Conditions

4.1. Storage

The transducer fulfils the specified data after treatment according to the conditions of

ETS 300 019-2-1 Specification of environmental test: Storage
Test spec. T 1.2: Weather protected, not temperature controlled storage locations.

4.2. Transportation

The transducer fulfils the specified data after treatment according to the conditions of

ETS 300 019-2-2 Specification of environmental test: Transportation
Test Spec. T 2.3: Public Transportation

4.3. Functionality

The transducer fulfils the specified data after treatment according to the conditions of

ETS 300 019-2-5 Specification of environmental test: Ground vehicle installations
Test spec. T 5.1: Protected installation

ETS 300 019-2-7 Specification of environmental test: Portable and non-stationary use
Test spec. T 7.3E: Partly weather protected and non-weather protected locations.

5. Environmental tests

5.1. Qualification tests

According to our milestone plan (Product Creation Process), a complete qualification test will be done at design validation of products manufactured under serial conditions.

1x per year and product family a requalification takes place. The qualification process covers all tests described under 5.5 and a complete inspection.

5.2. Reliability tests

1x per month and product family samples are taken and submitted to tests described under 5.5.2

5.3. Sample Size, Sequence

Unless otherwise stated 20 arbitrary new samples will be used to perform each test for both, qualification and requalification test as described under 5.1 and 5.2.

5.4. Period of Shelf-Life

The period of shelf-life is 2 years.

5.5. Testing Procedures

5.5.1. Storage Tests

5.5.1.1. Low Temperature Storage Test

Parameter	Test Method and Conditions	Duration	Evaluation Standard
Low Temperature Storage (Ref. EN 60068-2-1)	-40°C rel. humidity not controlled	168h	Measurements after 2 hours recovery time. All samples fully operable. All acoustical parameters according specification with tolerances increased by 50 %.

5.5.1.2. High Temperature Storage Test

Parameter	Test Method and Conditions	Duration	Evaluation Standard
Dry Heat Storage (Ref. EN 60068-2-2)	+85°C rel. humidity not controlled	168h	Measurements after 2 hours recovery time. All samples fully operable. All acoustical parameters according specification with tolerances increased by 50 %.

2403 260 00051

5.5.1.3. Temperature Cycle Test

Parameter	Test Method and Conditions	Duration	Evaluation Standard
Change of Temperature (Ref. EN 60068-2-14)	-40°C/+85°C Transition time <3 min. See Figure 5-1 below	5 cycles >2h for each temperature	Measurements after 2 hours recovery time. All samples fully operable. All acoustical parameters according specification with tolerances increased by 50 %.

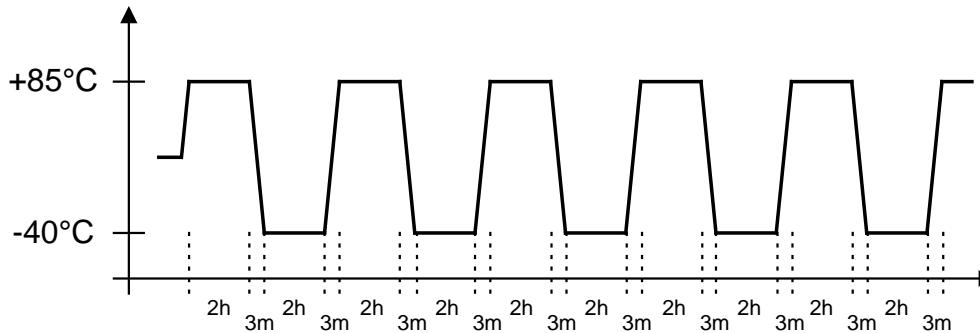

Figure 5-1: Temperature Cycle Test

5.5.1.4. Temperature / Humidity Cycle Test

Parameter	Test Method and Conditions	Duration	Evaluation Standard
Damp heat, cyclic (Ref. IEC 60068-2-30)	+25°C/+55°C 90% to 95% RH. Temp. change time <3h See Figure 5-2 below <u>Caution:</u> no condensed water on products!	6 cycles. 24h at each temperature	Measurements after 2 hours recovery time. All samples fully operable. All acoustical parameters according specification with tolerances increased by 50 %.

Figure 5-2: Temperature / Relative Humidity Cycle Test

5.5.2.

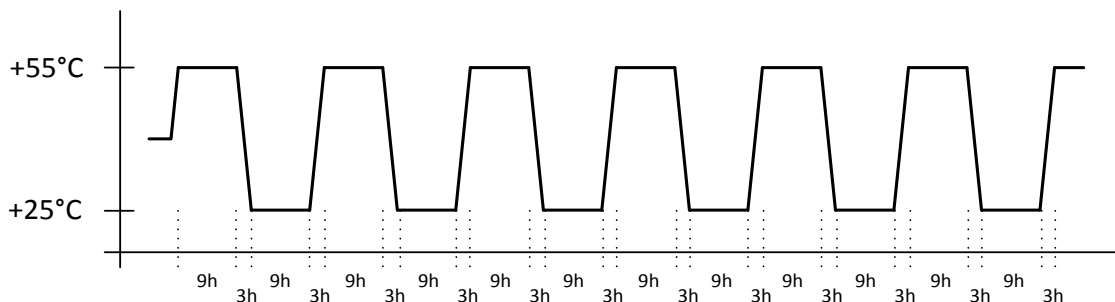

Operating Tests

5.5.2.1. Cold Operation Test

Parameter	Test Method and Conditions	Duration	Evaluation Standard
Cold Operation Test (Ref. EN 60068-2-1)	-20°C rel. humidity not controlled signal acc. Chapter 3.3	72h	Measurements after 2 hours recovery time. All samples fully operable. THD may be increased after test. All other acoustical parameters according specification with tolerances increased by 50 %.

5.5.2.2. Dry Heat Operation Test

Parameter	Test Method and Conditions	Duration	Evaluation Standard
Dry Heat Operation (Ref. EN 60068-2-2)	+70°C rel. humidity not controlled signal acc. Chapter 3.3	500h	Measurements after 2 hours recovery time. All samples fully operable. The allowable change in sensitivity shall not be greater than 3 dB. All other acoustical parameters according specification with tolerances increased by 50 %.

5.5.3. Salt Mist Test

Parameter	Test Method and Conditions	Duration	Evaluation Standard
Salt Mist (Ref. IEC60068-2-52, Kb / Severity 2)	The part must be subjected to 2 hours spray of 5% NaCl salt mist, at 35°C then be left at 40°C and 95% RH for 22h.	3 cycles	The samples shall be washed after the test with distilled water and dried at T< 50°C. Component may have reduced performance, but must still function properly. The allowable sensitivity difference shall not be greater than ±3dB from initial sensitivity.

2403 260 00051

5.5.4. Shock Resistance Test (Free Fall Test) - unprotected product

Parameter	Test Method and Conditions	Conditions / Sample size	Evaluation Standard
Mechanical shock (Ref. IEC60068-2-32 Ed), Procedure 1	Drop of sample without fixation of release plane from a height of 1.5m onto concrete floor.	Each 3 shocks in both directions of the 3 axes. (18 drops in total)	Component may have reduced performance, but must still function properly. The allowable sensitivity difference shall not be greater than ± 3 dB from initial sensitivity.

5.5.5. Impact Durability Test (Tumble Test) – protected product

Parameter	Test Method and Conditions	Conditions / Sample size	Evaluation Standard
Impact durability (in a Tumble Tester) (Ref. IEC60068-2-32 Ed) (SPR a7.1.1)	Speaker <i>in drop test box</i> or representative mechanics. Random drops on steel base.	30 units 180 drops, 1m DUT power off	Component may have reduced performance, but must still function properly. The allowable sensitivity difference shall not be greater than ± 3 dB from initial sensitivity.

5.5.6. Resistance to Electrostatic Discharge

Parameter	Test Method and Conditions	Conditions / Sample size	Evaluation Standard
Resistance to ESD IEC61000-4-2 Level 4 (SPR c 2.5.1)	One pole is grounded and the ESD pulse is applied to the other pole. The speaker must be stressed first with one polarisation and then with the other polarisation. DUT must be discharged between each ESD exposure. Level 4: contact +/- 8kV, air +/- 15kV	10 exposures on each polarity / 5 units DUT Power off	All samples fully operable. All acoustical parameters according specification with tolerances increased by 50%.

2403 260 00051

6. Related Documents

IEC 268-5	Sound System equipment Part 5: Loudspeaker
IEC 68-2	Environmental testing
EN 60068-2	Environmental testing
ISO 2859 - 1	Sampling procedures for inspection by attributes Part 1: Sampling plans indexed by acceptable quality level (AQL) for lot-by-lot inspection
ISO 3951	Sampling procedures and charts for inspection by variables for percent defectives.
ETS 300 019-2-1	Specification of environmental test: Storage Test spec. T 1.2: Weather protected, not temperature controlled storage locations
ETS 300 019-2-2	Specification of environmental test: Transportation Test spec. T 2.3: Public Transportation
ETS 300 019-2-5	Specification of environmental test: Ground vehicle installations Test spec. T 5.1: Protected installation
ETS 300 019-2-7	Specification of environmental test: Portable and non-stationary use Test spec. T 7.3E: Partly weather protected and non-weather protected locations

2403 260 00051

7. Change History

Status	Version	Date	ECR	Comment / Changes	Initials of owner
Obsolete	A	19.08.10	2909	First release	CP/ET/AS
Obsolete	B	07.01.11	3055	Update frequency response/lifetime test signal	AH
Obsolete	C	24.03.11	3125	Update printing code/migration to Knowles template	SA/CP
Obsolete	D	26.05.11	3180	Update printing code illustration/shelf life	CP/PD
Obsolete	E	26.07.11	3207	Shelf life 2 years	CP
Release	F	03.01.12	3428	Correct THD curve/new frontpage picture Change of short term max power	OL/CP/AH

8. Disclaimer

Stresses above the Absolute Maximum Ratings may cause permanent damage to the device. These are stress ratings only. The device may not function when operated at these or any other conditions beyond those indicated under “Electrical and Acoustical Specifications”. Exposure beyond those indicated under “Electrical and Acoustical Specifications” for extended periods may affect device reliability.

This product is not qualified for use in automotive applications

Frequency range in telecom application:
300 Hz – 3,4 kHz

The information contained in this literature is based on our experience to date and is believed to be reliable and it is subject to change without notice. It is intended as a guide for use by persons having technical skill at their own discretion and risk. We do not guarantee favorable results or assume any liability in connection with its use. Dimensions contained herein are for reference purposes only. For specific dimensional requirements consult factory. This publication is not to be taken as a license to operate under, or recommendation to infringe any exiting patents. This supersedes and voids all previous literature.

