

28V-Capable, I LIM VBUS Accessory Switch

General Description

The MAX14544/MAX14545 are overcurrent detection switches that can provide power to external accessories while preventing the host device from damage due to faulty overload conditions. These analog switches feature a 270m Ω (typ) on-resistance and operate from a +2.3V to +5.5V input voltage range. The selectable current limit of 200mA or 400mA makes them ideal for load-switching applications.

The MAX14544 has an autoretry feature, whereas the MAX14545 has a latching feature. When the switch is off, OUT can withstand 28V maximum. When the switch is on and a load is connected to the port, a blanking time of 10.5ms ensures that the transient voltage settles down. After this blanking time, if the voltage across the switch is greater than the $\overline{\text{FLAG}}$ assertion voltage, the switch turns off and then a $\overline{\text{FLAG}}$ is issued to the microprocessor. After the retry time, the device recloses for the duration of the blanking time to check if the load current is lower than the limit. The MAX14544 repeats this cycle if the overload condition is present. During the cycle, $\overline{\text{FLAG}}$ remains asserted. The MAX14544 remains on after the overload condition is removed and $\overline{\text{FLAG}}$ deasserts. For the MAX14545, after the blanking time, the switch turns off and then a $\overline{\text{FLAG}}$ is issued to the microprocessor. The switch can be turned on again by cycling the power or the EN input.

The MAX14544/MAX14545 have additional safety features that include thermal shutdown protection, reverse-current blocking, and overvoltage protection.

The MAX14544/MAX14545 are offered in a space-saving, 8-pin, 2mm x 2mm TDFN package, and operate over the -40°C to +85°C extended temperature range.

Applications

Cell Phones
MP3 Players
PDAs
Digital Cameras
eBook
MID

Typical Operating Circuit appears at end of data sheet.

Features

- ◆ 200mA or 400mA Selectable Current Limit
- ◆ Output Capable of Withstanding +28V
- ◆ Reverse-Current Shutdown Protection
- ◆ +2.3V to +5.5V Input Operation Range
- ◆ Undervoltage Lockout
- ◆ Autoretry or Latching Option
- ◆ Thermal Shutdown Protection
- ◆ 0.1 μ A (typ) Shutdown Current
- ◆ 5 μ s Fast Current-Limit Detect
- ◆ 8-Pin TDFN (2mm x 2mm) Package
- ◆ -40°C to +85°C Operating Temperature Range

Ordering Information/ Selector Guide

PART	PIN-PACKAGE	TOP MARK	RETRY/LATCHOFF
MAX14544ETA+T	8 TDFN-EP*	ACY	Autoretry
MAX14545ETA+T	8 TDFN-EP*	ACZ	Latching

Note: All devices are specified over the -40°C to +85°C temperature range.

+Denotes a lead(Pb)-free/RoHS-compliant package.

T = Tape and reel.

*EP = Exposed pad.

Pin Configuration

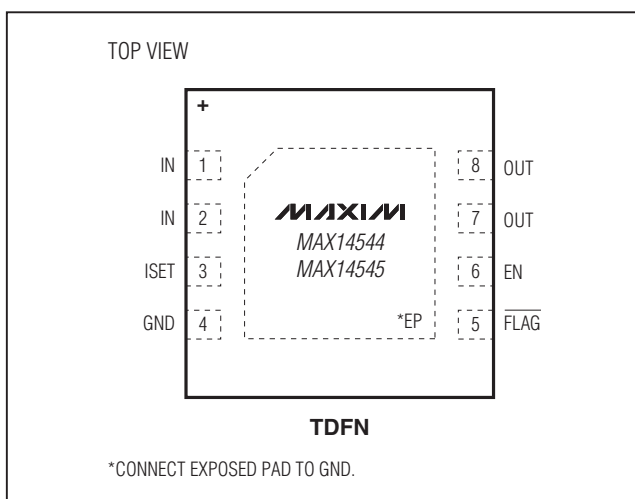

28V-Capable, ILIM VBUS Accessory Switch

ABSOLUTE MAXIMUM RATINGS

(Voltages referenced to GND.)

OUT	-0.3V to +30V
IN, $\overline{\text{FLAG}}$, EN, ISET	-0.3V to +6.0V
Continuous Power Dissipation (TA = +70°C)	
8-Pin TDFN (derate 11.9mW/°C above +70°C)	953mW
Junction-to-Ambient Thermal Resistance	
θ_{JA} (Note 1)	83.9°C/W

Junction-to-Case Thermal Resistance

θ_{JC} (Note 1)	37°C/W
Operating Temperature Range	-40°C to +85°C
Storage Temperature Range	-65°C to +150°C
Junction Temperature	-40°C to +150°C
Lead Temperature (soldering, 10s)	+300°C
Soldering Temperature (reflow)	+260°C

Note 1: Package thermal resistances were obtained using the method described in JEDEC specifications. For detailed information on package thermal considerations, refer to www.maxim-ic.com/thermal-tutorial.

Stresses beyond those listed under "Absolute Maximum Ratings" may cause permanent damage to the device. These are stress ratings only, and functional operation of the device at these or any other conditions beyond those indicated in the operational sections of the specifications is not implied. Exposure to absolute maximum rating conditions for extended periods may affect device reliability.

ELECTRICAL CHARACTERISTICS

(VIN = +2.3V to +5.5V, TA = -40°C to +85°C, unless otherwise noted. Typical values are at VIN = +3.3V, TA = +25°C.) (Note 2)

PARAMETER	SYMBOL	CONDITIONS	MIN	TYP	MAX	UNITS
Operating Voltage Range	VIN		2.3		5.5	V
Undervoltage Lockout	VUVLO	VIN falling	1.8		2.2	V
Undervoltage Lockout Hysteresis				100		mV
IN Overvoltage Trip Level	VOVLO	VIN rising	5.5		6.0	V
IN Overvoltage Hysteresis				1		%
Quiescent Current	IQ	VEN = VIN = 3.3V, IOUT = 0A		225	380	μA
OUT Voltage	VOUT	Switch off			28	V
OUT Leakage Current	IOUTL	VEN = VIN = 5V, VOUT = 5V after an overcurrent fault		0.2	1	μA
		VEN = VIN = 5V, VOUT = 10V after an overcurrent fault			3.5	
IN Shutdown Current	ISHDN	VEN = 0V, VIN = 5V, VOUT = 0V, VISET = 0V		0.1	1.1	μA
		VEN = 0V, VIN = 5V, VOUT = 10V, VISET = 0V		0.1	1.1	
Switch On-Resistance	RON	IOUT = 100mA, VIN = 2.3V		370	600	mΩ
		IOUT = 100mA, VIN > 3.3V		270	450	
Current Limit	ILIM	VISET = 0V, VIN - VOUT = 1V	200	250	300	mA
		VISET = VIN, VIN - VOUT = 1V	400	500	600	
$\overline{\text{FLAG}}$ Assertion Voltage	VFA	VFA = VIN - VOUT, where overcurrent is detected and $\overline{\text{FLAG}}$ asserted	0.30	0.45	0.60	V
Reverse-Current Detection Threshold	IDET	VEN = VIN = 3.3V, VOUT rising until reverse-current shutdown protection trips	0	155	350	mA
Reverse-Current Detection Hysteresis		After a reverse overcurrent event, VOUT falls below VIN until switch turns on, measure VIN - VOUT	100	200	300	mV

28V-Capable, I_{LIM} V_{BUS} Accessory Switch

MAX14544/MAX14545

ELECTRICAL CHARACTERISTICS (continued)

(V_{IN} = +2.3V to +5.5V, T_A = -40°C to +85°C, unless otherwise noted. Typical values are at V_{IN} = +3.3V, T_A = +25°C.) (Note 2)

PARAMETER	SYMBOL	CONDITIONS	MIN	TYP	MAX	UNITS
Input Logic-High Voltage	V _{IH}		1.4			V
Input Logic-Low Voltage	V _{IL}				0.4	V
Input Leakage	I _{IN}	V _{EN} = V _{ISET} = 0V or 5V	-1		+1	μA
Output Logic-Low Voltage	V _{OL}	I _{SINK} = 1mA			0.4	V
Output High Leakage Current		V _{FLAG} = 5V			1	μA
Thermal Shutdown		V _{IN} = 5V		150		°C
Thermal Shutdown Hysteresis		V _{IN} = 5V		15		°C
TIMING CHARACTERISTICS (Note 3)						
Turn-On Time	t _{ON}	V _{EN} from low to high, V _{IN} = 3.3V, R _L = 100Ω			0.3	ms
Turn-Off Time	t _{OFF}	V _{EN} from high to low, V _{IN} = 3.3V, R _L = 100Ω		1		ms
Current-Limit Reaction Time	t _{LIM}	V _{EN} = V _{IN} = 3.3V, output high and then short circuit applied, C _{IN} = 10μF ceramic, C _{OUT} = 1μF ceramic		5		μs
Blanking Time	t _{BLANK}	V _{EN} = V _{IN} = 3.3V, Figures 1 and 2	4	10.5	30	ms
Autoretry Time	t _{RETRY}	MAX14544, Figure 1	252	661.5	1890	ms
Reverse-Current Detection Time	t _{DET}	V _{IN} = 3.3V, I _{REVERSE} = 250mA, C _{IN} = 10μF ceramic, C _{OUT} = 1μF ceramic		5		μs
Reverse-Current Recovery Time	t _{REC}	V _{OUT} = V _{IN} + 500mV to V _{OUT} = V _{IN} - 500mV		0.1		ms

Note 2: All devices are production tested at T_A = +25°C. Specifications over temperature limits are guaranteed by design.

Note 3: All timing characteristics are measured using 20% and 80% levels.

28V-Capable, ILIM VBUS Accessory Switch

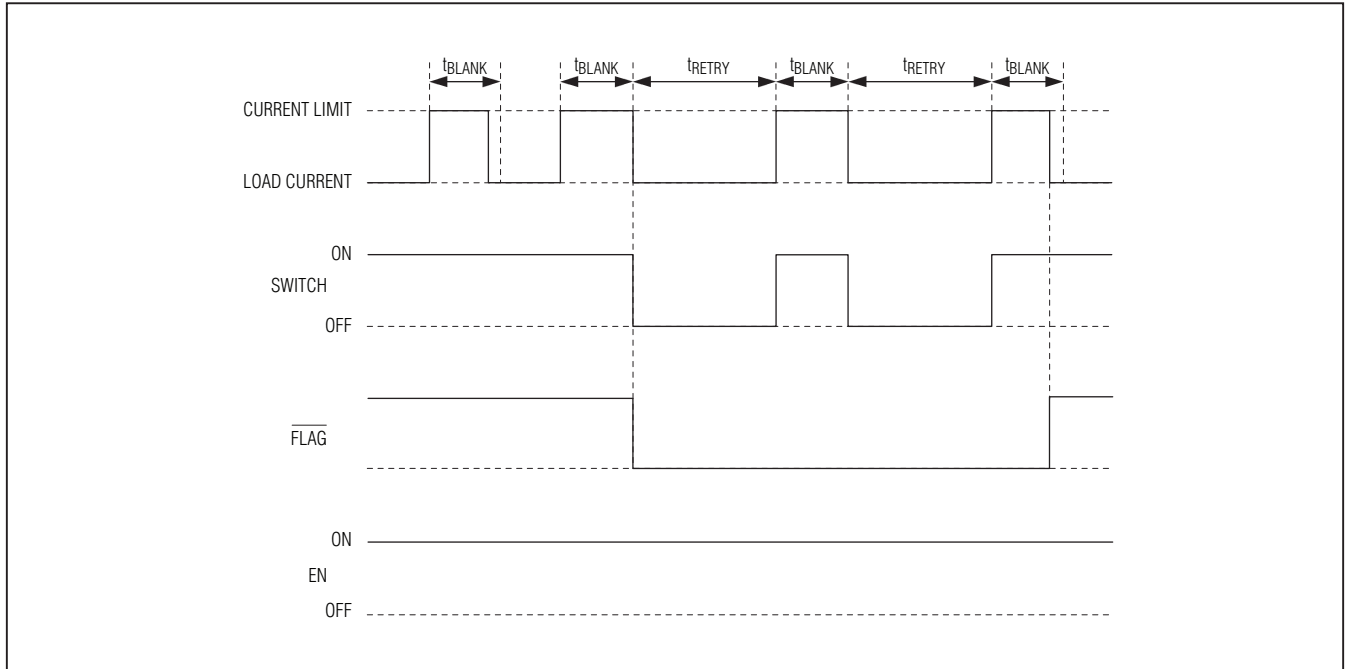

Figure 1. MAX14544 Timing Diagram (Waveforms Not to Scale)

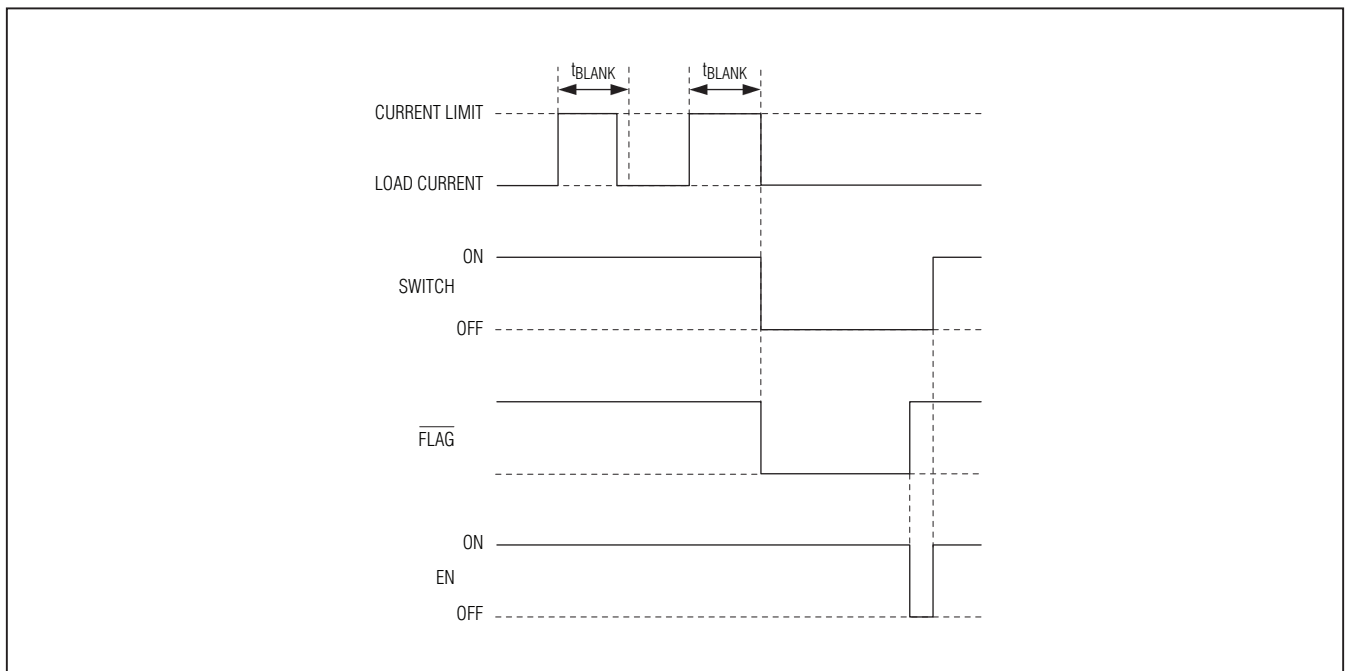

Figure 2. MAX14545 Timing Diagram (Waveforms Not to Scale)

28V-Capable, I_{LIM} V_{BUS} Accessory Switch

Typical Operating Characteristics

(V_{IN} = +3.3V, C_{IN} = 10μF, C_{OUT} = 1μF, T_A = +25°C, unless otherwise noted.)

MAX14544/MAX14545

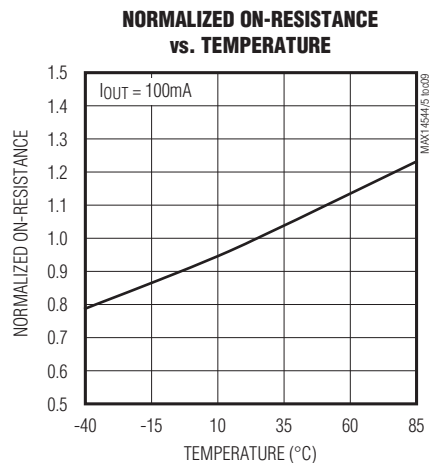
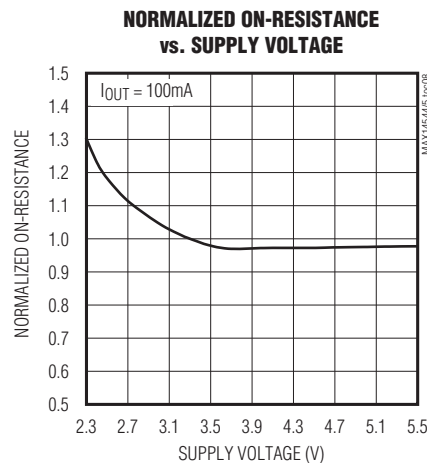
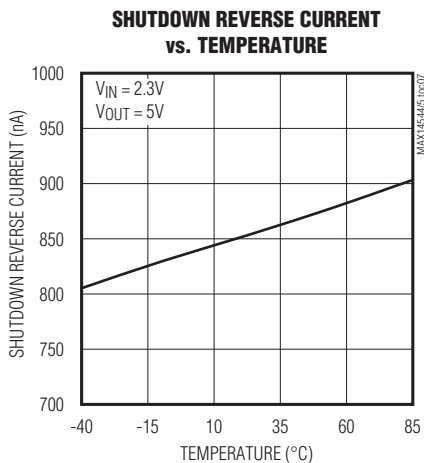
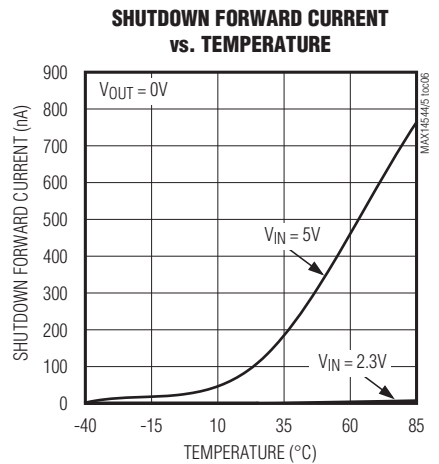
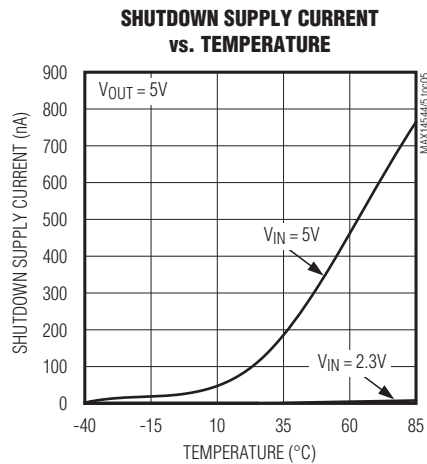
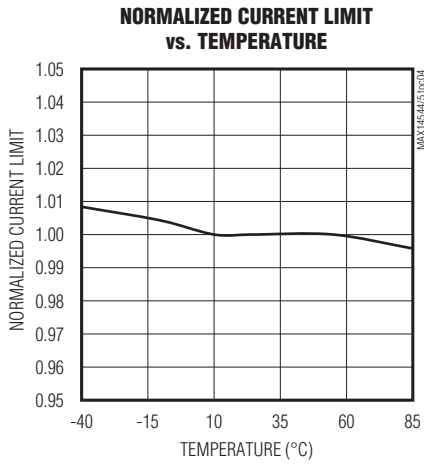
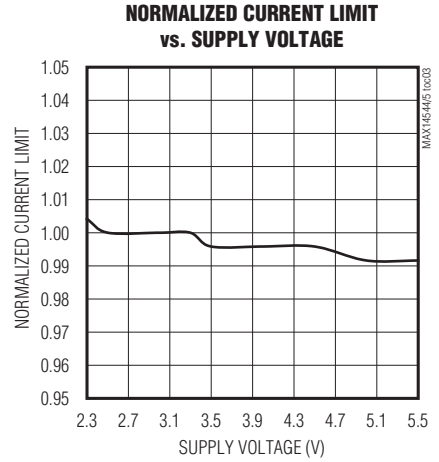
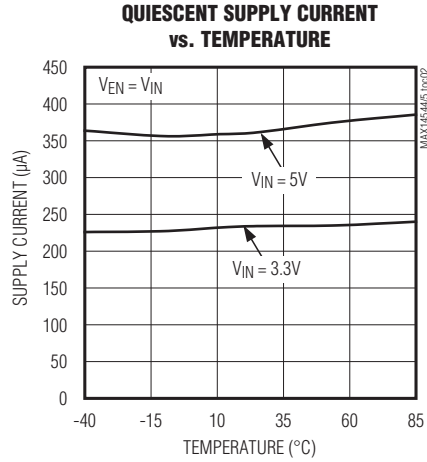
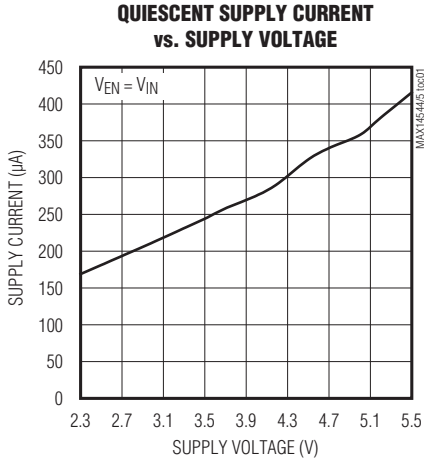

28V-Capable, I LIM VBUS Accessory Switch

Typical Operating Characteristics (continued)

($V_{IN} = +3.3V$, $C_{IN} = 10\mu F$, $C_{OUT} = 1\mu F$, $T_A = +25^\circ C$, unless otherwise noted.)

SWITCH TURN-ON TIME vs. TEMPERATURE

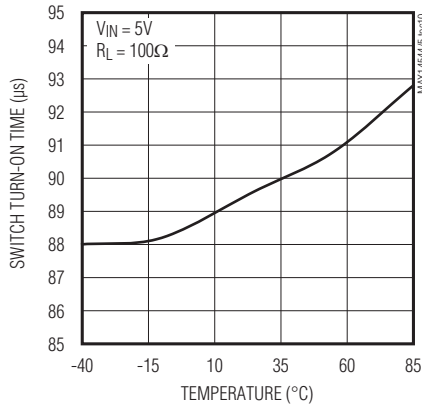

SWITCH TURN-OFF TIME vs. TEMPERATURE

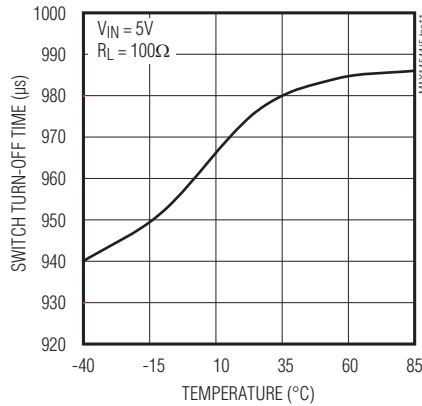

POWER-UP RESPONSE

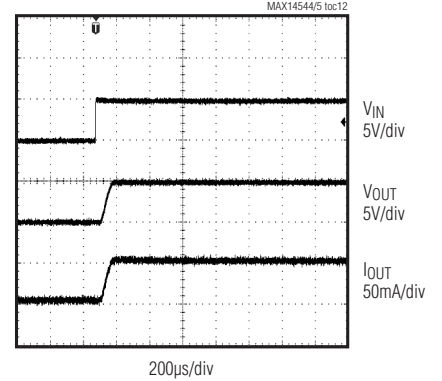

REVERSE OVERVOLTAGE PROTECTION

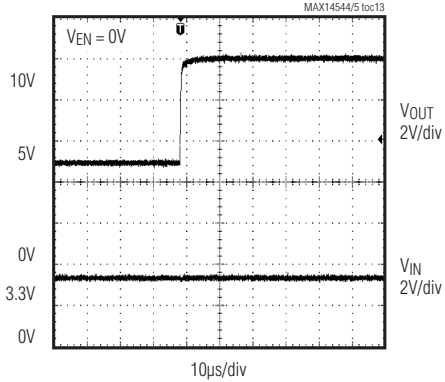

FLAG RESPONSE

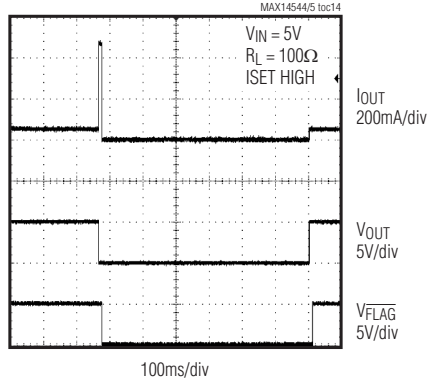

CURRENT LIMIT RESPONSE

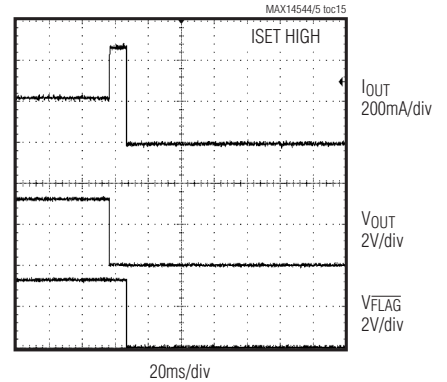

CURRENT LIMIT RESPONSE

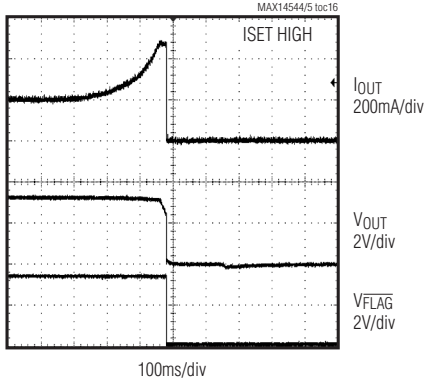

OVERCURRENT DURATION TIME

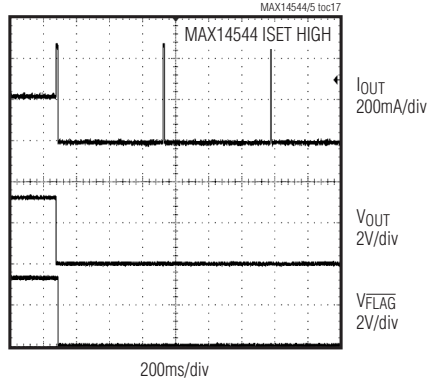

BLANKING TIME

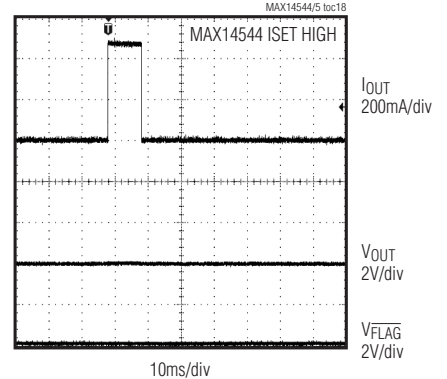

28V-Capable, I_{LIM} V_{BUS} Accessory Switch

Pin Description

PIN	NAME	FUNCTION
1, 2	IN	Input Voltage. Connect IN pins 1 and 2 together and bypass IN to GND with a 10μF ceramic capacitor as close to the device as possible.
3	ISET	Current-Limit Setting. Drive ISET low to have a 200mA current limit. Drive ISET high to have a 400mA current limit.
4	GND	Ground
5	FLAG	Active-Low Fault Open-Drain Output. $\overline{\text{FLAG}}$ goes low when the forward output current limit is exceeded for longer than the blanking time, the reverse current limit is exceeded, the OVP threshold on IN is reached, or the part goes into thermal shutdown. $\overline{\text{FLAG}}$ is high impedance when EN is low or a fault is not present.
6	EN	Active-High Switch-Enable Input. Drive EN high to turn on the device. Drive EN low to turn off the device.
7, 8	OUT	Output Voltage. Connect OUT pins 7 and 8 together and bypass OUT to GND with a 1μF ceramic capacitor as close to the device as possible.
—	EP	Exposed Pad. Connect EP to GND. For enhanced thermal dissipation, connect EP to a large copper ground plane. Do not use EP as the sole ground connection.

MAX14544/MAX14545

Functional Diagram

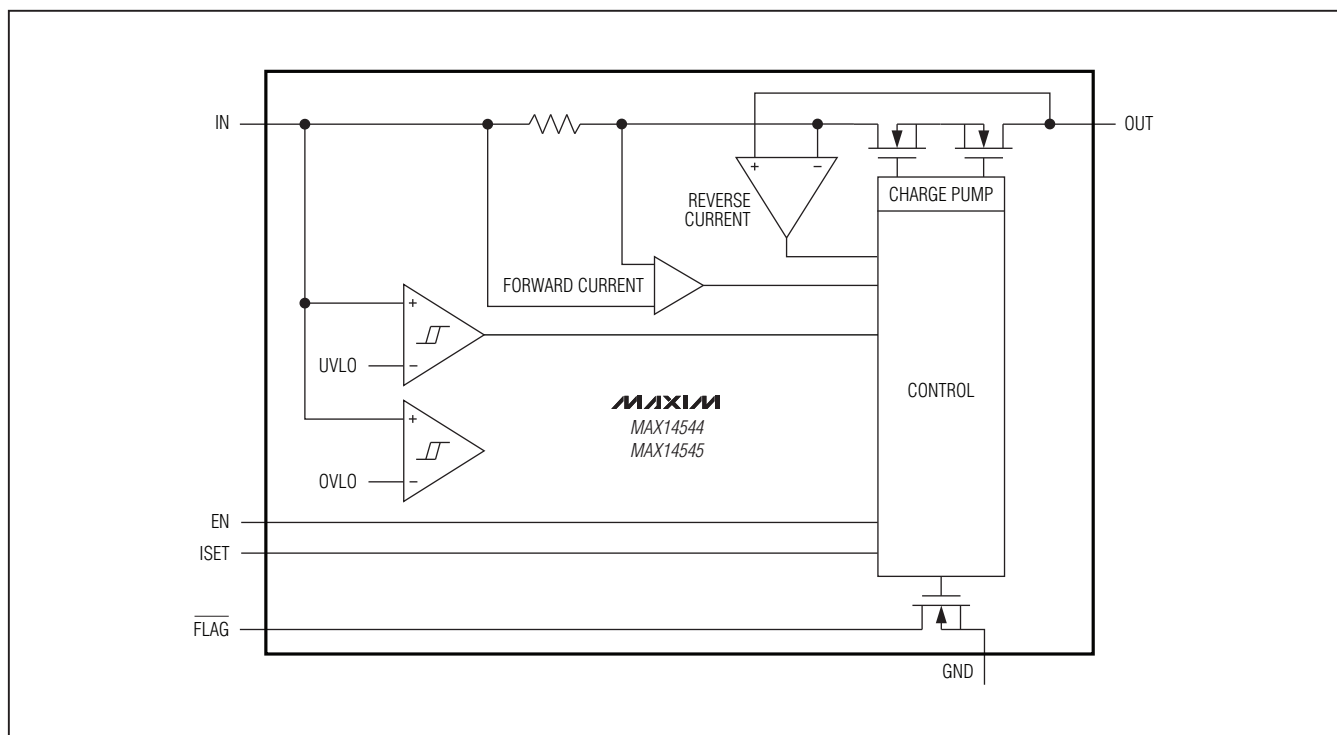

28V-Capable, ILIM VBUS Accessory Switch

Detailed Description

The MAX14544/MAX14545 are overcurrent detection switches that prevent host devices from being damaged due to faulty load conditions. The switch opens if current exceeds the current limit for longer than the blanking time or if a reverse-current condition is detected. The switch also disconnects if V_{IN} exceeds OVLO, V_{IN} falls below UVLO, thermal shutdown occurs, or EN is driven low. Current limit can be set to either 200mA or 400mA. When the switch is open, the output (OUT) can withstand 28V maximum.

When the switch is on and a load is connected to the port, a blanking time of 10.5ms ensures that the inrush current settles down. After this blanking time, if the voltage across the switch is greater than the \overline{FLAG} assertion voltage, the part is turned off and issues a \overline{FLAG} to the microprocessor. After the retry time elapses, the MAX14544 switch is closed for the duration of the blanking time to check if the load current is lower than the limit. Cycle the power or EN input to turn the MAX14545 switch back on.

Current-Limit Threshold

The MAX14544/MAX14545 ISET logic input sets the desired minimum current-limit threshold to 200mA or 400mA. Connect ISET low for a 200mA current limit and high for a 400mA current limit. If 400mA is selected as the current limit, the input supply current at shutdown can be reduced by connecting ISET to EN. This is due to the fact that the device consumes the lower supply current in ISET = low mode than in ISET = high mode.

Reverse-Current Protection

The MAX14544/MAX14545 monitor the reverse current (V_{OUT} to V_{IN}) from exceeding the maximum I_{DET} value. If the reverse-current detection threshold is exceeded, the switch turns off and \overline{FLAG} is asserted without waiting for t_{BLANK} to elapse. This feature prevents excessive reverse currents from flowing through the device.

\overline{FLAG} Indicator

The MAX14544/MAX14545 feature a fault output (\overline{FLAG}). Whenever $V_{IN} - V_{OUT} > V_{FA}$, the MAX14544 asserts \overline{FLAG} low after the blanking time and keeps it low until the condition is removed. During this time, the switch cycles on and off in the autoretry mode. When the condition is removed, \overline{FLAG} deasserts and the switch turns on (Figure 1). The MAX14545 asserts \overline{FLAG} low after the blanking time and turns the switch off when \overline{FLAG} assertion voltage is exceeded (Figure 2).

\overline{FLAG} is an open-drain output and requires an external pullup resistor. During shutdown (EN is low), the pull-down on \overline{FLAG} output is released to limit power dissipation. \overline{FLAG} goes low when one of the following occurs:

- 1) The temperature exceeds the thermal shutdown temperature, +150°C (typ).
- 2) The device is in current limit for more than the fault blanking period.
- 3) The switch is in autoretry.
- 4) The reverse current limit is exceeded.
- 5) The input is over the OVLO.

Autoretry (MAX14544)

When the \overline{FLAG} assertion voltage is exceeded, the t_{BLANK} timer begins counting (Figure 1). The timer resets if the condition disappears before t_{BLANK} has elapsed. A retry time delay (t_{RETRY}) is started immediately after t_{BLANK} has elapsed and during that time the switch is turned off and \overline{FLAG} is asserted. At the end of t_{RETRY} , the device is turned on again. If the fault still exists, the cycle is repeated. If the fault is removed, the device stays on and \overline{FLAG} deasserts.

The autoretry feature saves system power in the case of a continuous overcurrent or short-circuit condition. During t_{BLANK} , when the switch is on, the supply current is at the current limit. During t_{RETRY} , when the switch is off, the current through the switch is zero. Instead of observing the full load current, the device sees the equivalent load current times duty cycle or:

$$I_{SUPPLY} = I_{LOAD} \times t_{BLANK} / (t_{BLANK} + t_{RETRY})$$

With a typical $t_{BLANK} = 10.5\text{ms}$ and typical $t_{RETRY} = 661.5\text{ms}$, the duty cycle is 1.6%, resulting in a 98.4% power savings over the switch being on the entire time.

Latchoff (MAX14545)

When the \overline{FLAG} assertion voltage is exceeded, the t_{BLANK} timer begins counting. The device turns off after the blanking time. The timer resets if the condition is removed before the end of the blanking time. Reset the device by toggling EN (Figure 2).

Fault Blanking

The MAX14544/MAX14545 feature a 10.5ms (typ) fault blanking. Fault blanking allows current-limit faults, including momentary short-circuit faults that occur when plugging a capacitive load, and also ensures that no fault is issued during power-up. When a load transient causes the device to enter current limit, an internal counter starts. If the load-transient fault persists beyond the

28V-Capable, I_{LIM} V_{BUS} Accessory Switch

fault-blanking timeout, $\overline{\text{FLAG}}$ asserts low. $\overline{\text{FLAG}}$ is not asserted when load-transient fault is less than t_{BLANK} . The fault blanking time only applies to forward current-limit faults.

A reverse current-limit fault, thermal fault, or OVP fault causes $\overline{\text{FLAG}}$ to assert immediately and does not wait for the blanking time.

Thermal Shutdown

The MAX14544/MAX14545 have a thermal-shutdown feature to protect the devices from overheating. The device turns off and $\overline{\text{FLAG}}$ goes low immediately (no fault blanking) when the junction temperature exceeds +150°C. The MAX14544/MAX14545 turns back on when the device temperature drops approximately 15°C.

OVLO and UVLO

The MAX14544/MAX14545 feature an overvoltage protection. When IN goes above V_{OVLO} (6.0V max), the switch turns off and $\overline{\text{FLAG}}$ goes low immediately with no fault-blanking time. When IN drops below V_{UVLO} (1.8V min), the switch turns off but $\overline{\text{FLAG}}$ stays high. The MAX14544/MAX14545 turns back on when IN is in the operating range.

Applications Information

Input Capacitor

To limit the input-voltage drop during momentary output short-circuit conditions, connect a capacitor from IN to GND. A 10 μ F ceramic capacitor is adequate for most applications; however, higher capacitor values further reduce the voltage drop at the input and are recommended for lower voltage applications.

Output Capacitor

Connect a 1 μ F ceramic capacitor from OUT to GND. This capacitor helps prevent inductive parasitics from pulling OUT negative during turn-off, thus preventing

the MAX14544/MAX14545 from tripping erroneously. If the load capacitance is too large, then current may not have enough time to charge the capacitance and the device assumes that there is faulty load condition. The maximum capacitive load value that can be driven from OUT is obtained by the following formula:

$$C_{\text{MAX}} < \frac{I_{\text{FWD_MIN}} \times t_{\text{BLANK_MIN}}}{V_{\text{IN}}}$$

Layout and Thermal Dissipation

To optimize the switch response time to output short-circuit conditions, it is very important to keep all traces as short as possible to reduce the effect of undesirable parasitic inductance. Place input and output capacitors as close as possible to the device. IN and OUT must be connected with short traces to the power bus.

During normal operation, the power dissipation is small and the package temperature change is minimal. If the output is continuously shorted to ground at the maximum supply voltage, the operation of the switches with the autoretry option does not cause problems because the total power dissipated during the short is scaled by the duty cycle:

$$P_{\text{MAX}} = \frac{V_{\text{IN_MAX}} \times I_{\text{OUT_MAX}} \times t_{\text{BLANK}}}{t_{\text{RETRY}} + t_{\text{BLANK}}} = 51.6\text{mW}$$

where $V_{\text{IN_MAX}} = 5.5\text{V}$, $I_{\text{OUT_MAX}} = 600\text{mA}$, $t_{\text{BLANK}} = 10.5\text{ms}$, and $t_{\text{RETRY}} = 661.5\text{ms}$.

Attention must be given to the MAX14545 where the latching condition can be manually reset by toggling EN from high to low. If the latching time duration is not sufficiently high, it is possible for the device to reach the thermal-shutdown threshold and never be able to turn the device on until it cools down.

28V-Capable, LIM VBUS Accessory Switch

Typical Operating Circuit

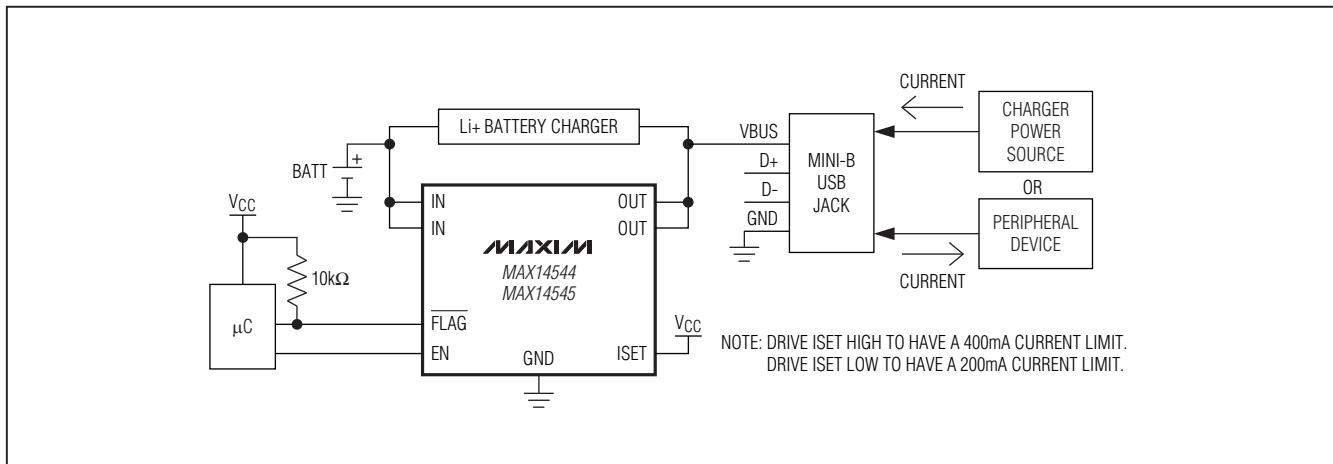

Chip Information

PROCESS: BiCMOS

Package Information

For the latest package outline information and land patterns, go to www.maxim-ic.com/packages. Note that a "+", "#", or "-" in the package code indicates RoHS status only. Package drawings may show a different suffix character, but the drawing pertains to the package regardless of RoHS status.

PACKAGE TYPE	PACKAGE CODE	DOCUMENT NO.
8 TDFN-EP	T822+2	21-0168

Maxim cannot assume responsibility for use of any circuitry other than circuitry entirely embodied in a Maxim product. No circuit patent licenses are implied. Maxim reserves the right to change the circuitry and specifications without notice at any time.

10 **Maxim Integrated Products, 120 San Gabriel Drive, Sunnyvale, CA 94086 408-737-7600**

© 2010 Maxim Integrated Products

Maxim is a registered trademark of Maxim Integrated Products, Inc.