

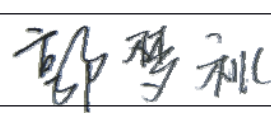
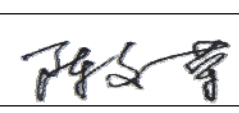

**金龙机电股份有限公司**  
**JINLONG MACHINERY & ELECTRONIC CO., LTD.**  
 www.jinlong-machinery.com  
 sales@jinlong-machinery.com

## 规格书

### SPECIFICATION

客 户 信 息	客户名称/Customer	
	客户料号/Part No.	
	客户承认签章 Customer Approved Signatures	

文件编号/Spec No.	KOTL-B-327	
品名/Description	圆柱直流马达/Cylindrical DC motor	
型号/Part No.	Z6DH2B1501851	
设计/Designed	审核/Checked	批准/Approved
		
<b>2009.05.14</b>	<b>2009.05.14</b>	<b>2009.05.14</b>

# 规格书内容/Contents

1、适用范围/ General Scope	3/9
2、使用条件/ Operating Conditions	3/9
3、测定条件/ Measuring Conditions	3/9
4、机械要求/ Mechanical Specifications	3/9
5、性能特征/Performance and characteristics	4/9
6、可靠性/Reliability	5/9
7、要求/Requirements	6/9
8、使用时注意事项/ attentions	6/9
9、包装/Packaging	7/9
10、外形图/Outline Drawing	8/9
11、修改记录 / REVISION HISTORY	9/9

型号/ Part No.	Z6DH2B1501851
--------------	---------------

1. 适用范围/ General Scope  
 本说明书适用于圆筒式永磁直流电机 Z6DH2B1501851 型  
 This specification applies to cylindrical permanent-magnetic motors DC model  
 Z6DH2B1501851

2. 使用条件/ Operating Conditions

	项目/Item	规格/Specifications	条件·备注/Conditions & Remarks
2-1	额定电压 Rated voltage	3.0V DC	
2-2	额定负荷 Rated load	振子 Counterweight	见 10. 外形图 As specified in 10. Outline Drawing
2-3	旋转方向 Rotation	C.W/C.C.W (clockwise or counter clockwise)	
2-4	马达位置 Motor position	全方位 All position	
2-5	使用电压范围 Operating voltage	2.2~3.6V DC	
2-6	使用环境 Operating environment	-30 ~ 70℃, 常湿 /Ordinary Humidity:65±20%RH	无水气凝结 No condensation of moisture
2-7	保存环境 Storage environment	-40 ~ 80℃, 常湿 /Ordinary Humidity:65±20%RH	无水气凝结 No condensation of moisture

3. 测定条件/ Measuring Conditions

	项目/Item	规格/Specifications	条件·备注/Conditions & Remarks
3-1	温度 Temperature	20±2℃	
3-2	湿度 Humidity	(63%~67%) RH	
3-3	位置 Motor position	轴向水平 Motor shaft horizontal	将马达固定在试验台上 Lock the motor in a test fixture

标准测试条件为温度 20℃, 湿度 65%。如无疑异, 也可在温度 5~35℃、湿度 45~85% 的条件下测试。马达测试时, 放置方向为轴向水平。/The measurement at 20℃ & 65%RH is standard. If the judgment is not questionable, recognize measurement at 5℃ to 35℃ & relative humidity 45% to 85%. Direction of motor is shaft horizontal.

4. 机械要求/ Mechanical Specifications

	项目/Item	规格/Specifications	条件·备注/Conditions & Remarks
4-1	结构 Configuration	见 10. 外形图 As specified in 10. Outline Drawing	Outline drawing No: Z6DH2B1501851
4-2	外观 Appearance	不含有机机械损坏及不适当的浸蚀等。 There shall be no evidence of mechanical damage and shall not have inadequate corrosion and so on	目测 (容许范围根据样品外形) Visual examination(allowable extent is based on boundary sample)
4-3	轴向间隙 Shaft end play	0.1mm~0.3mm	
4-4	振子固定力 Holding strength of vibration weight	49N (5kgf) Min	

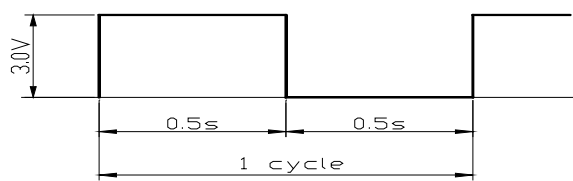
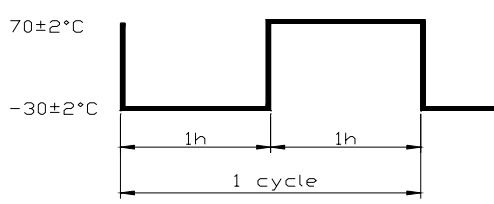

6. 可靠性/Reliability

项目/Item		规格/Specification					判定标准/Judgment	
6-1	寿命 Life time						在常温常湿下放置 2h 后，马达应符合项 7-1 的要求。 After 2 hours exposure in ordinary temperature and humidity, Motors shall be approved as specified in item 7-1.	
		位置 Position	电压 Volt	负荷 Load	温度 Temp	湿度 Humi		寿命 Life
		轴水平 Horizon	额定 Rated	重量 Weight 振子	20°C	65%		200,000 Cycles
6-2	低温放置 Low temp exposure	温度 时间	/Temperature: -40±2°C /Time: 96h				在常温常湿下放置 2h 后，马达应符合项 7-2 的要求。 After 2 hours exposure in ordinary temperature and humidity, Motors shall be approved as specified in item 7-2.	
6-3	高温放置 High temp. Exposure	温度 时间	/Temperature: 60±2°C /Time: 96h					
6-4	湿度放置 Humidity exposure	温度 湿度 放置时间 无水气凝结/No condensation of moisture	/Temperature: 40±2°C /Humidity: 90~95%RH /Exposure time: 96h					
6-5	振动 Vibration	全振幅 频率 加速度 周期 方向 时间	/Displacement : 1.5mm (p-p) /Frequency: 10 ~ 55Hz /Acceleration: 22m/s <sup>2</sup> /Period: 20min 完成 10~55~10Hz /20 Minutes log sweep 10~55~10Hz /Direction: x, y, z /Time: 每个方向 2h /Each 2 hours					
6-6	自然跌落 Free fall	试验状态/Test state: 高度 方向 次数	将马达固定在约 75 克（包括马达本身）的物体上，落向水泥地面。 Set the motor to the approximately 75g (include the motor) weight of block drop the motor on the concrete floor. /Height: 1.5m /Direction: 6 个面 / 6 faces /Number of times: 每个面 2 次 / Twice 2 each				测试结果应符合项 7-2 的要求。 After the test motors shall be approved as specified in item 7-2.	
6-7	热冲击 Heat shock test	试验循环	/Test cycle :20 cycles				在常温常湿下放置 2h 后，马达应符合项 7-2 的要求。 After 2 hours exposure in ordinary temperature and humidity, Motors shall be approved as specified in item 7-2.	
								

## 7. 要求/Requirements

项目/Item		判定基准 / Requirements
7-1	表 A Table A	1) 额定转速/Rated speed: 不低于初始值-30%,不高于初始值+60% Initial data -30% Min, Initial data +60% Max 2) 额定电流/Rated current: 不大于初始值±30%/Initial data±30% max 3) 起动电压/Starting voltage: 2.4V DC Max
7-2	表 B Table B	1) 额定转速/Rated speed: 不大于初始值±30%/Initial data±30% max 2) 额定电流/Rated current: 不大于初始值±30%/Initial data±30% max 3) 起动电压/Starting voltage: 2.4V DC Max

## 8. 使用时注意事项/Matters to be paid attention to when using motor

8-1 电机在运输过程中应小心轻放，避免严重碰撞敲击引起的电机机身和性能受损。(Please lay the motors carefully in transportation to avoid any serious damage to the motor body or its electric function because of collision.)

8-2 请按照规格书中规定的第 2 条(使用条件)来使用和存储电机，否则会影响电机性能。(Please use and storage motors according to N0.2 item (Operating Conditions) in specification, or else motor characteristics would be affected.)

8-3 请在 6 个月内使用。在使用和打开马达外包装时请避免水气凝结。(Make arrangement to limit the storage period to 6 months or less. Condensation of atmosphere must be avoided in motor usage or opening the packaging of the motor.)

8-4 马达应适当的操作、储存和运转环境中均不可存在腐蚀性气体。例如：H<sub>2</sub>S、SO<sub>2</sub>、NO<sub>2</sub>、CL<sub>2</sub> 等。另外存储环境中不可有诸如硅、氰、甲醛水和苯酚等能放射出腐蚀性气体的物质，在电机的机械构造或装置中，如果存在腐蚀性气体，那么这会引起马达不运转。(For proper operation. storage and operating environment must not contain corrosive gases. For example H<sub>2</sub>S. SO<sub>2</sub>. NO<sub>2</sub>. CL<sub>2</sub>. etc. In addition storage environment must not have materials that emit corrosive gases especially from silicon. cyanic. formalin and phenol group. In the mechanism or the set. existence of corrosive gases may cause no rotation in motor.)

8-5 请通电后不要长时间堵住机轴，并且马达转动时不要触碰转子。(Please don't stall the shaft for a long time after powering, and not to touch the weight when motor is rotating.)

8-6 马达轴向间隙处不应有杂物(如颗粒、纤维物、头发、胶带、胶水等)(There should be no sundries (such as grain, fibre, hair, small tape, glue etc.) in the shaft end play.)

(Z6DH2) 圆柱马达包装  
Packaging drawing of Z6DH2 cylindrical motor

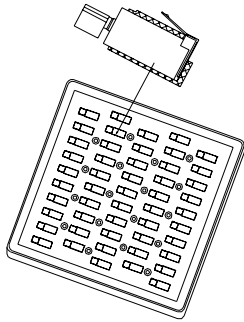

50PCS (1 tray) × 20

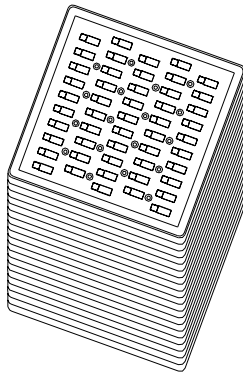

1000PCS (1 bundle)

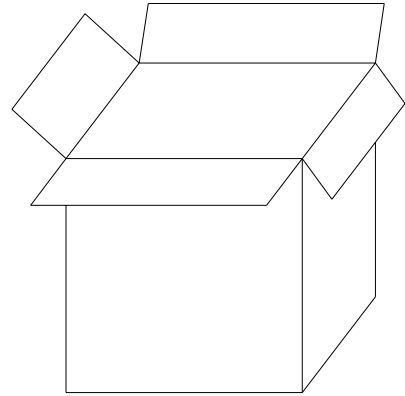

1 bundle × 4

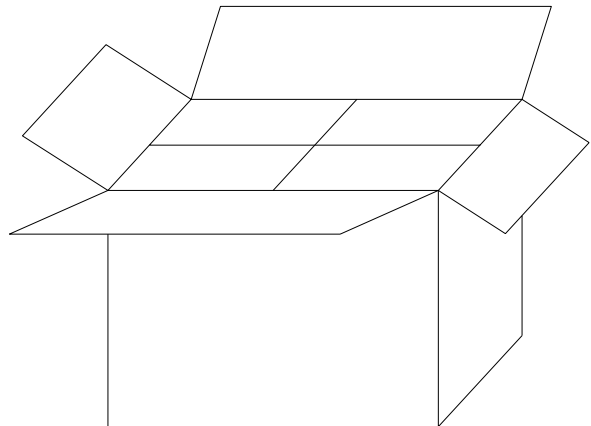
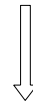

包装试验要求

1. 标准

- (1) 整箱重量小于等于9kg的, 跌落高度设定为75cm.
- (2) 整箱重量大于9kg但小于等于23kg的, 跌落高度设定为60cm.

2. 试验方法:

跌落要求为六面三棱一角.

- (1) 六面: 先从最大两面跌, 然后是中间大小的两面, 最后跌最小的两面, 一共六次.
- (2) 三棱: 指任选三条同一角的棱, 跌落秩序: 最长棱, 中间长度, 最短的, 一共三次.
- (3) 一角: 指上一步三条棱所组成的角, 跌落一次.

3. 判定基准

经过跌落试验后, 产品外观、性能无不良.

Package Test Requirement:

1. Criteria

- (1) The weight of the whole carton less than 9kg, the dropping height is 75cm.
- (2) The weight of the whole carton more than 9kg and less than 23kg, the dropping height is 60cm.

2. Test Methods:

Dropping requirement is 6 faces, 3 arris, 1 angle.

- (1) 6 faces: First dropping with two biggest faces, then dropping with another two middle faces, at last dropping with two smallest faces, once per face, total 6 faces.
- (2) 3 arris: Choose any 3 arris which make up of the same the angle, the dropping sequence is the longest arris, middle arris, shortest arris. Total 3 times.
- (3) 1 angle: Point to the angle which is made up with the 3 arris in the above step. Dropping for 1 time.

3. Judgement Criterion

After drop test, no evidence of damage on the appearance and performance.

Remarks:

4000PCS/CTN:43cm × 21cm × 25.5cm

OPP TAPE

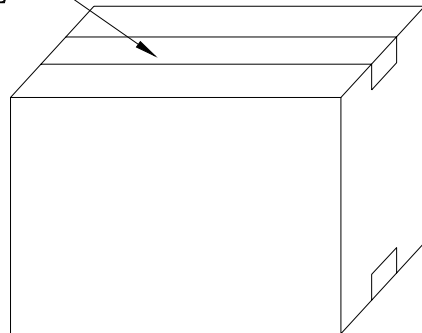

10. 外形图/Outline Drawing

www.jinlong-machinery.com

Z6DH2B1501851

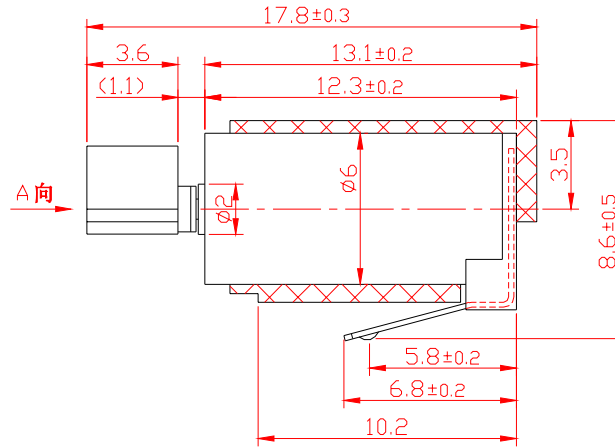
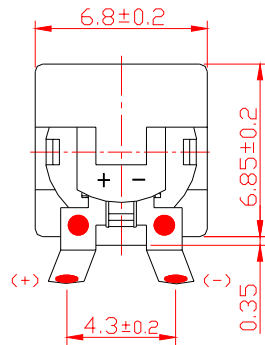

技术要求/Technical requirement

1. 额定电压/Rated voltage: 3.0V
2. 额定电流/Rated current: 75mA Max
3. 额定转速/Rated speed: 1100±2500 rpm
4. 堵转电流/Stall current: 125mA Max
5. 端子阻抗/Terminal resistance: 30Ω (±20%)
6. 起动电压/Starting voltage: 1.7V Max
7. 轴向间隙/Shaft end play: 0.05~0.2mm
8. 所有尺寸为A向压紧后的尺寸(不包括轴向间隙)  
/Overall length is measured after counterweight being pressed against body in direction A. (Shaft end play is not included.)
9. 未注线性公差为/Unmarked tolerance: ±0.1mm

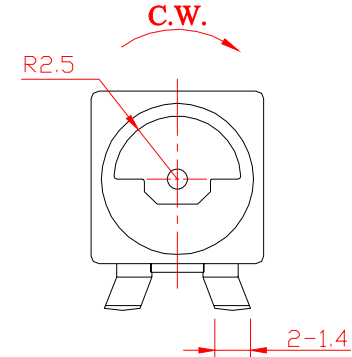

借(通)用件登记

底图总号

签字

日期

标记	处数	分区	更改文件号	签名	日期
设计	郭梦秋	2009.05.14	标准化	张其荣	2009.05.14
校对	杨兰	2009.05.14			
审核	陈文荣	2009.05.14			
工艺	刘林兵	2009.05.14	批准	项瑞坚	2009.05.14

jinlong-machinery.com		
阶段标记	重量	比例
		4:1
共 页	第 页	

金龙机股份有限公司

外形图

Z6DH2B1501851

2009.05.14

说明书/Specification

编号/NO. K07L-B-327

代码/code: 0

8/9



