

NPN Silicon AF Transistor Array

- For AF stages and driver applications
- High current gain
- Low collector-saturation voltage
- Two (galvanic) internal isolated transistors with good matching in one package
- Pb-free (RoHS compliant) package
- Qualified according AEC Q101

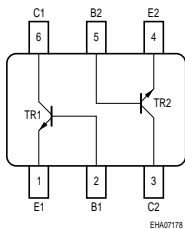
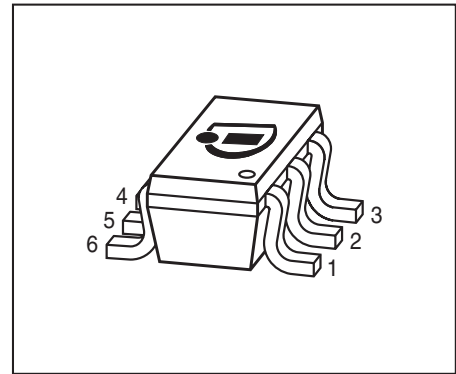

Type	Marking	Pin Configuration						Package
		1=E1	2=B1	3=C2	4=E2	5=B2	6=C1	
BC817U	6Bs	1=E1	2=B1	3=C2	4=E2	5=B2	6=C1	SC74

Maximum Ratings

Parameter	Symbol	Value	Unit
Collector-emitter voltage	V_{CEO}	45	V
Collector-base voltage	V_{CBO}	50	
Emitter-base voltage	V_{EBO}	5	
Collector current	I_C	500	mA
Peak collector current, $t_p \leq 10$ ms	I_{CM}	1000	
Base current	I_B	100	
Peak base current	I_{BM}	200	
Total power dissipation- $T_S \leq 115$ °C	P_{tot}	330	mW
Junction temperature	T_j	150	°C
Storage temperature	T_{stg}	-65 ... 150	

Thermal Resistance

Parameter	Symbol	Value	Unit
Junction - soldering point ¹⁾	R_{thJS}	≤ 105	K/W

Electrical Characteristics at $T_A = 25^\circ\text{C}$, unless otherwise specified

Parameter	Symbol	Values			Unit
		min.	typ.	max.	

DC Characteristics

Collector-emitter breakdown voltage $I_C = 10\text{ mA}, I_B = 0$	$V_{(BR)CEO}$	45	-	-	V
Collector-base breakdown voltage $I_C = 10\text{ }\mu\text{A}, I_E = 0$	$V_{(BR)CBO}$	50	-	-	
Emitter-base breakdown voltage $I_E = 10\text{ }\mu\text{A}, I_C = 0$	$V_{(BR)EBO}$	5	-	-	
Collector-base cutoff current $V_{CB} = 25\text{ V}, I_E = 0$ $V_{CB} = 25\text{ V}, I_E = 0, T_A = 150\text{ }^\circ\text{C}$	I_{CBO}	-	-	0.1 50	μA
Emitter-base cutoff current $V_{EB} = 4\text{ V}, I_C = 0$	I_{EBO}	-	-	100	nA
DC current gain ²⁾ $I_C = 100\text{ mA}, V_{CE} = 1\text{ V}$ $I_C = 300\text{ mA}, V_{CE} = 1\text{ V}$	h_{FE}	160 100	250 -	400 -	-
Collector-emitter saturation voltage ²⁾ $I_C = 500\text{ mA}, I_B = 50\text{ mA}$	V_{CEsat}	-	-	0.7	V
Base emitter saturation voltage ²⁾ $I_C = 500\text{ mA}, I_B = 50\text{ mA}$	V_{BEsat}	-	-	1.2	

AC Characteristics

Transition frequency $I_C = 50\text{ mA}, V_{CE} = 5\text{ V}, f = 100\text{ MHz}$	f_T	-	170	-	MHz
Collector-base capacitance $f = 1\text{ MHz}, V_{BE} = 10\text{ V}$	C_{cb}	-	6	-	pF
Emitter-base capacitance $V_{EB} = 0.5\text{ V}, f = 1\text{ MHz}$	C_{eb}	-	60	-	

¹⁾For calculation of R_{thJA} please refer to Application Note AN077 (Thermal Resistance Calculation)

²⁾Pulse test: $t < 300\mu\text{s}; D < 2\%$

DC current gain $h_{FE} = f(I_C)$

$V_{CE} = 1\text{ V}$

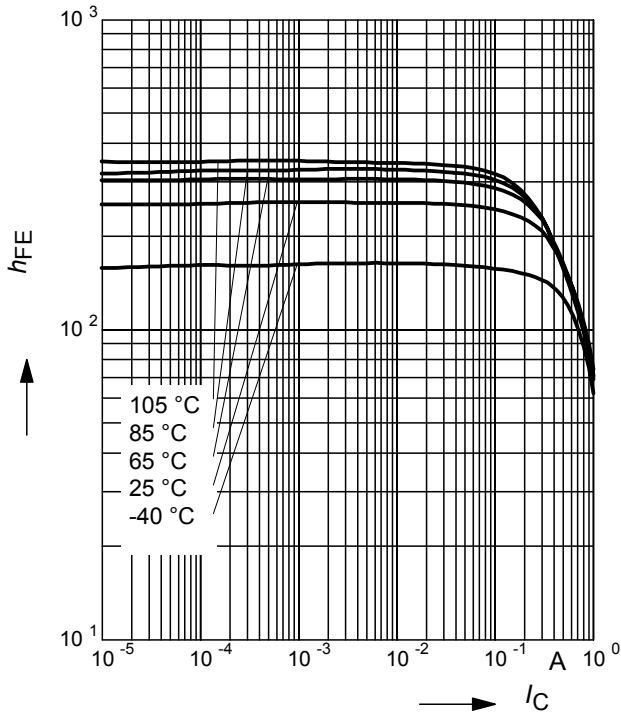

Collector-emitter saturation voltage

$I_C = f(V_{CEsat}), h_{FE} = 10$

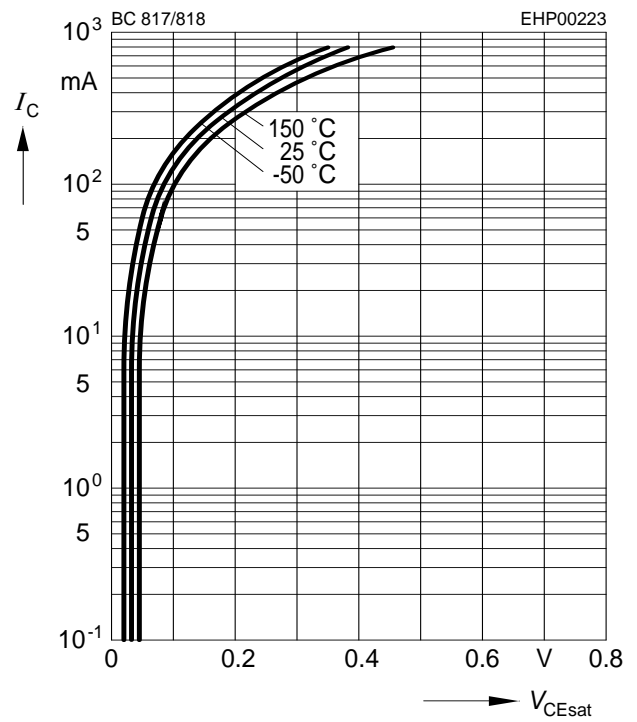

Base-emitter saturation voltage

$I_C = f(V_{BEsat}), h_{FE} = 10$

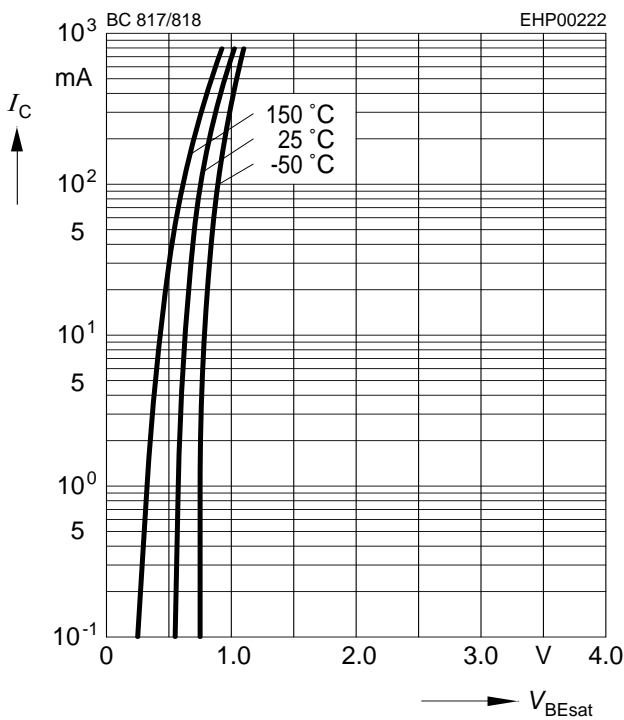

Collector cutoff current $I_{CBO} = f(T_A)$

$V_{CBO} = 25\text{ V}$

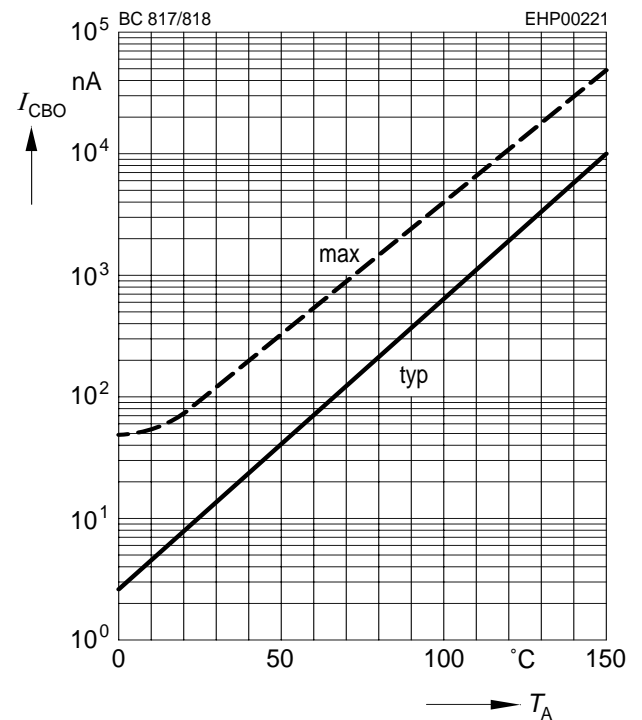

Transition frequency $f_T = f(I_C)$

V_{CE} = parameter in V, $f = 2$ GHz

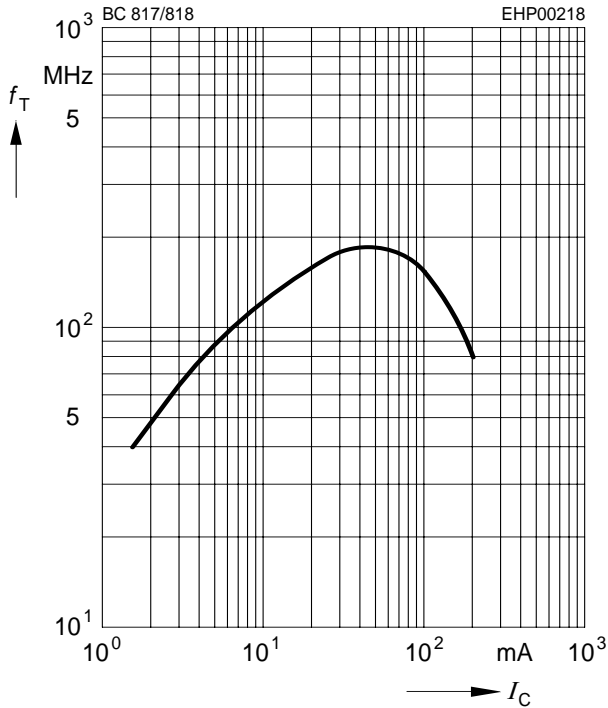

Collector-base capacitance $C_{cb} = f(V_{CB})$

Emitter-base capacitance $C_{eb} = f(V_{EB})$

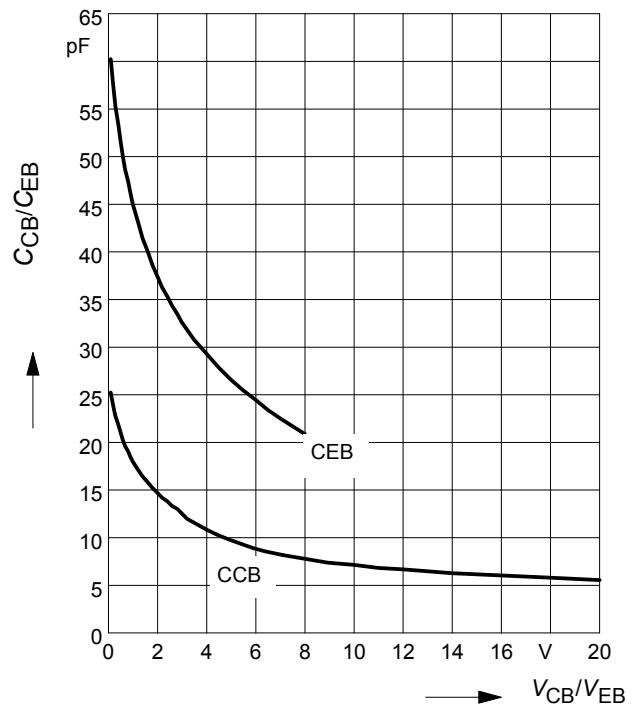

Total power dissipation $P_{tot} = f(T_S)$

Permissible Pulse Load $R_{thJS} = f(t_p)$

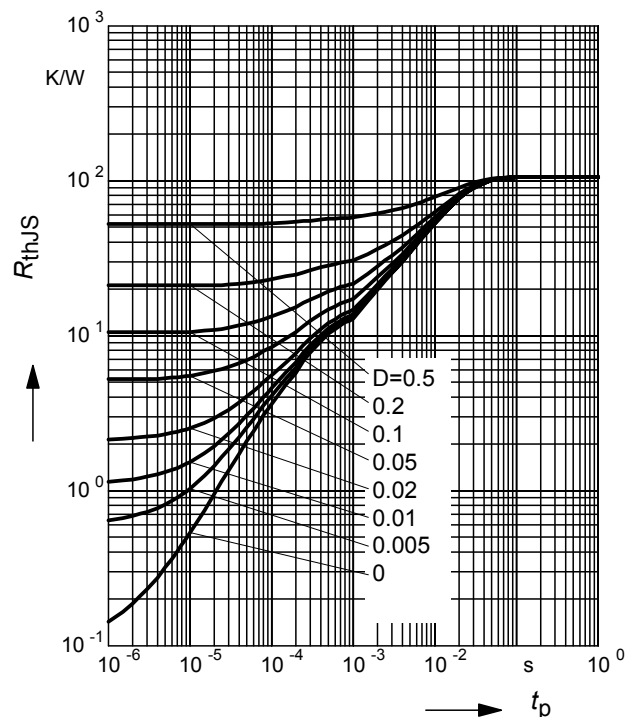
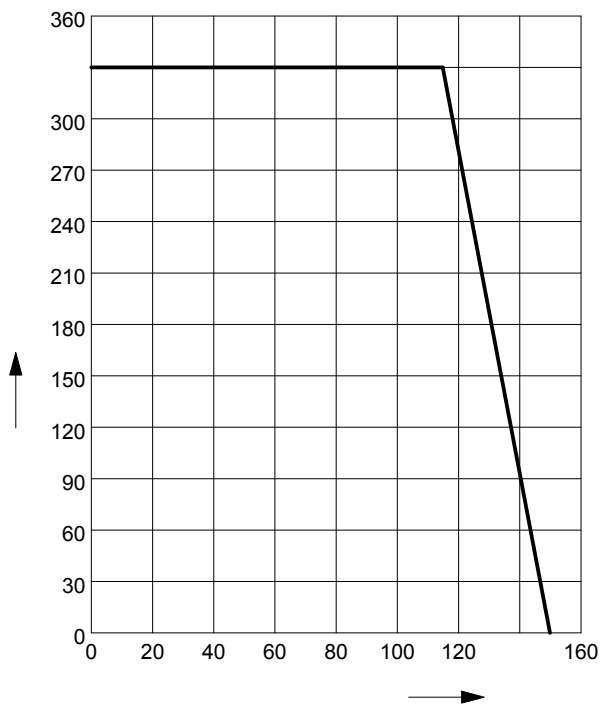

Permissible Pulse Load

$$P_{\text{totmax}}/P_{\text{totDC}} = f(t_p)$$

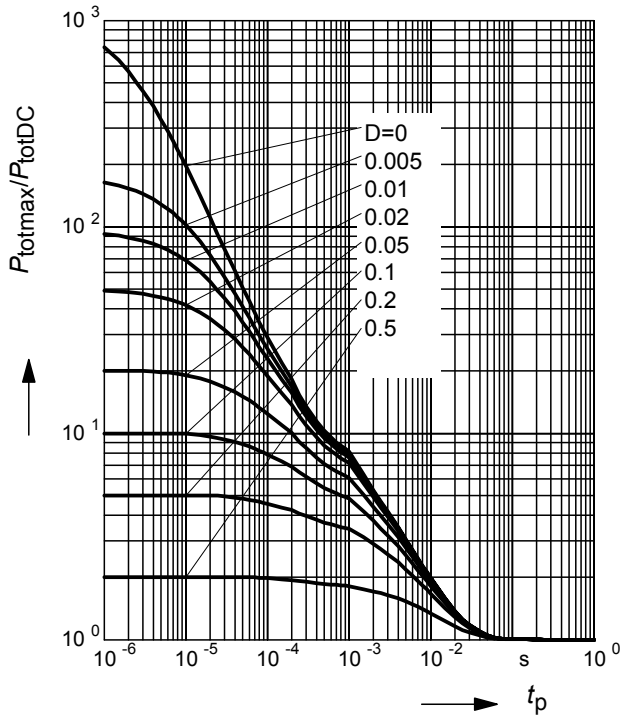

Package Outline

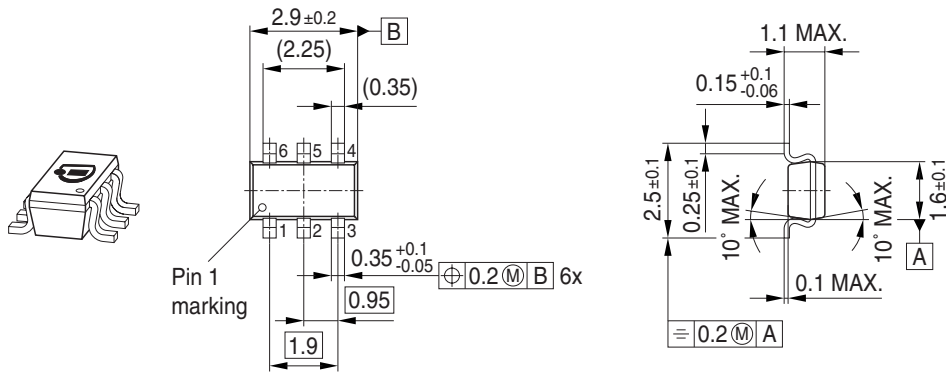

Foot Print



Marking Layout (Example)

Small variations in positioning of Date code, Type code and Manufacture are possible.

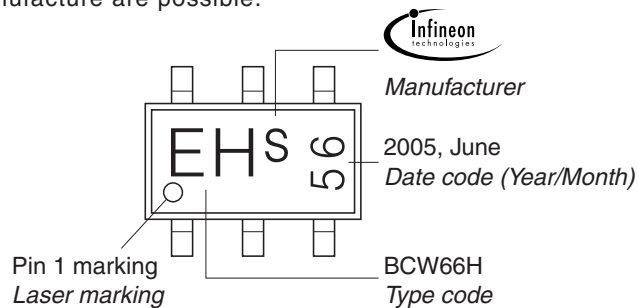

Standard Packing

Reel \varnothing 180 mm = 3.000 Pieces/Reel
 Reel \varnothing 330 mm = 10.000 Pieces/Reel

For symmetric types no defined Pin 1 orientation in reel.

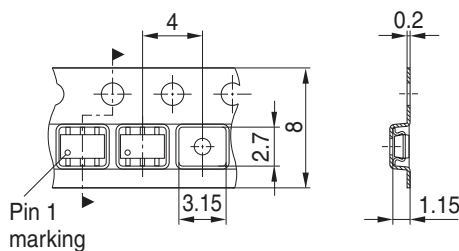

Edition 2009-11-16

**Published by
Infineon Technologies AG
81726 Munich, Germany**

**© 2009 Infineon Technologies AG
All Rights Reserved.**

Legal Disclaimer

The information given in this document shall in no event be regarded as a guarantee of conditions or characteristics. With respect to any examples or hints given herein, any typical values stated herein and/or any information regarding the application of the device, Infineon Technologies hereby disclaims any and all warranties and liabilities of any kind, including without limitation, warranties of non-infringement of intellectual property rights of any third party.

Information

For further information on technology, delivery terms and conditions and prices, please contact the nearest Infineon Technologies Office (www.infineon.com).

Warnings

Due to technical requirements, components may contain dangerous substances. For information on the types in question, please contact the nearest Infineon Technologies Office.

Infineon Technologies components may be used in life-support devices or systems only with the express written approval of Infineon Technologies, if a failure of such components can reasonably be expected to cause the failure of that life-support device or system or to affect the safety or effectiveness of that device or system. Life support devices or systems are intended to be implanted in the human body or to support and/or maintain and sustain and/or protect human life. If they fail, it is reasonable to assume that the health of the user or other persons may be endangered.