

## Basic Characteristics Data

Model	Circuit method	Switching frequency [kHz]	Input current [A]	Rated input fuse	Inrush current protection circuit	PCB/Pattern			Series/Parallel operation availability	
						Material	Single sided	Double sided	Series operation	Parallel operation
SNDHS50A	Forward converter	470	*1	400V 3.15A	-	FR-4		Yes	Yes	*2
SNDHS50B	Forward converter	470	*1	400V 1.6A	-	FR-4		Yes	Yes	*2
SNDHS100A	Forward converter	470	*1	400V 3.15A	-	FR-4		Yes	Yes	*2
SNDHS100B	Forward converter	470	*1	400V 1.6A	-	FR-4		Yes	Yes	*2
SNDHS200A	Forward converter	360	*1	400V 5.0A	-	FR-4		Yes	Yes	*2
SNDHS250B	Forward converter	360	*1	400V 3.15A	-	FR-4		Yes	Yes	*2

\*1 Refer to Specification.

\*2 Refer to Instruction Manual.

<b>1</b>	<b>Terminal Connection</b>	<b>SNDHS-16</b>
<b>2</b>	<b>Connection for Standard Use</b>	<b>SNDHS-17</b>
<b>3</b>	<b>Wiring Input/Output Terminal</b>	<b>SNDHS-18</b>
3.1	Wiring input terminal .....	SNDHS-18
3.2	Wiring output terminal .....	SNDHS-18
<b>4</b>	<b>Function</b>	<b>SNDHS-19</b>
4.1	Overcurrent protection .....	SNDHS-19
4.2	Overvoltage protection .....	SNDHS-19
4.3	Thermal protection .....	SNDHS-19
4.4	Remote ON/OFF .....	SNDHS-19
4.5	Remote sensing .....	SNDHS-19
4.6	Output voltage adjusting .....	SNDHS-20
4.7	Withstanding voltage / Isolation voltage .....	SNDHS-20
<b>5</b>	<b>Series and Parallel Operation</b>	<b>SNDHS-20</b>
5.1	Series operation .....	SNDHS-20
5.2	Redundancy operation .....	SNDHS-20
<b>6</b>	<b>Implementation · Mounting Method</b>	<b>SNDHS-21</b>
6.1	Mounting method .....	SNDHS-21
6.2	Derating .....	SNDHS-21
<b>7</b>	<b>Option and Others</b>	<b>SNDHS-22</b>
7.1	Outline of option .....	SNDHS-22

# 1 Terminal Connection

## ●SNDHS50A/100A

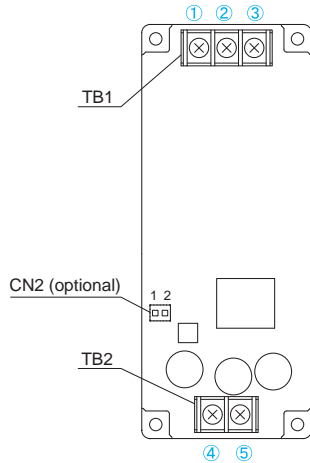

## ●SNDHS200A

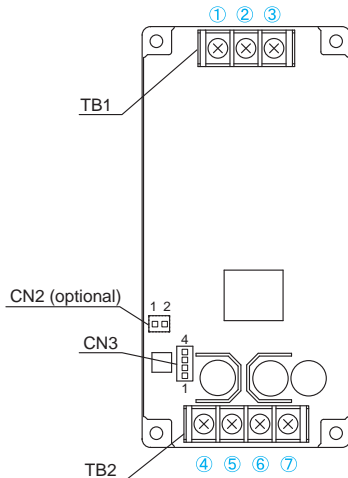

Fig.1.1 Terminal connection (top view)

Table 1.1 Terminal connection and function

No.		Terminal connection	Function
SNDHS 50A/100A	SNDHS 200A		
①	①	+VIN	+DC input
②	②	-VIN	-DC input
③	③	FG	Frame Ground
④	④ ⑤	+VOUT	+DC output
⑤	⑥ ⑦	-VOUT	-DC output

Pin configuration and functions of CN2 (Optional)

Pin No.	Function
1	+RC : +Remote ON/OFF
2	-RC : -Remote ON/OFF

Pin configuration and functions of CN3

Pin No.	Function
1	-M : -Self sensing terminal. (Do not wire for external connection.)
2	-S : -Remote sensing
3	+S : +Remote sensing
4	+M : +Self sensing terminal. (Do not wire for external connection.)

Mating connectors and terminals on CN2, CN3

Connector	Mating connector	Terminal	Mfr.
CN2	B2B-XH-AM	XHP-2	Chain : SXH-001T-P0.6 Loose : BXH-001T-P0.6
		XHP-4	Chain : SXH-001T-P0.6 Loose : BXH-001T-P0.6

## ●SNDHS50B/100B

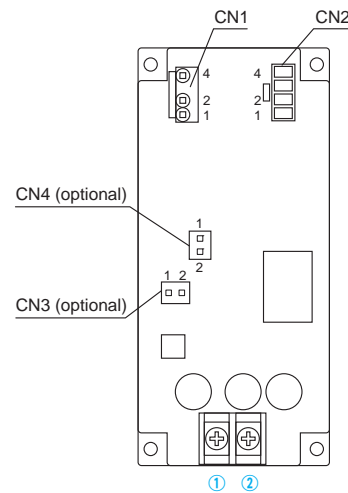

## ●SNDHS250B

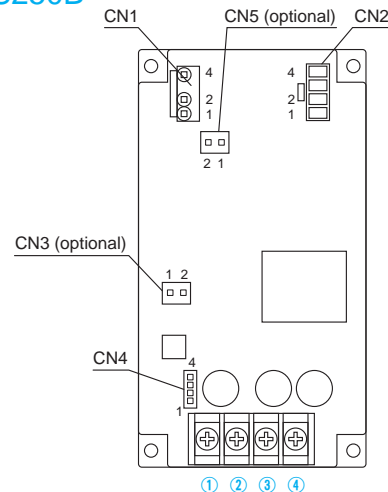

Fig.1.2 Terminal connection (top view)

Table 1.2 Terminal connection and function

No.		Terminal connection	Function
SNDHS 50B/100B	SNDHS 250B		
①	① ②	+VOUT	+DC output
②	③ ④	-VOUT	-DC output

Pin configuration and functions of CN1 and CN2

Pin No.	Function
1	RC1 : Remote ON/OFF
2	-VIN : -Input Voltage
3	NC : No connection
4	+VIN : +Input Voltage

CN1 and CN2 are connected internally.

Pin configuration and functions of CN3:Optional

Pin No.	Function
1	+RC2 : +Remote ON/OFF
2	-RC2 : -Remote ON/OFF

Pin configuration and functions of CN4:Optional(SNDHS50B/100B)

Pin No.	Function
1	+RC3 : +Remote ON/OFF
2	-RC3 : -Remote ON/OFF

Pin configuration and functions of CN4(SNDHS250B)

Pin No.	Function
1	-M : -Self sensing terminal. (Do not wire for external connection.)
2	-S : -Remote sensing
3	+S : +Remote sensing
4	+M : +Self sensing terminal. (Do not wire for external connection.)

Pin configuration and functions of CN5:Optional(SNDHS250B)

Pin No.	Function
1	+RC3 : +Remote ON/OFF
2	-RC3 : -Remote ON/OFF

Mating connectors and terminals on CN1, CN2, CN3, CN4 and CN5

SNDHS 50B/100B	SNDHS 250B	Connector	Mating connector	Terminal	Mfr.
CN1	CN1	B3P4-VH	VHR-4N	Chain : SVH-21T-P1.1	J.S.T.
CN2	CN2			Loose : BVH-21T-P1.1	
CN3	CN3	B2B-XH-AM	XHP-2	Chain : SXH-001T-P0.6	
CN4	CN5			Loose : BXH-001T-P0.6	
-	CN4	B4B-XH-AM	XHP-4	Chain : SXH-001T-P0.6	
				Loose : BXH-001T-P0.6	

## 2 Connection for Standard Use

■ In order to use the power supply, it is necessary to wire as shown in Fig.2.1, Fig.2.2.

### ● SNDHS50A/100A/200A

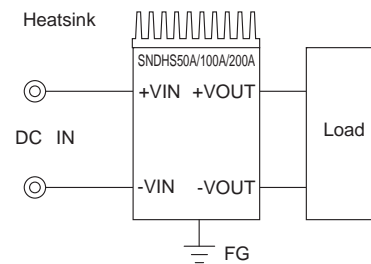

Fig.2.1 Connection for standard use

### ● SNDHS50B/100B/250B

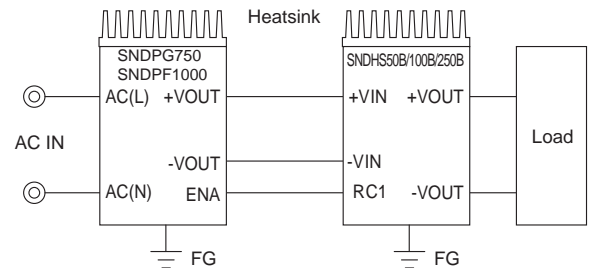

Fig.2.2 Connection 1 for standard use

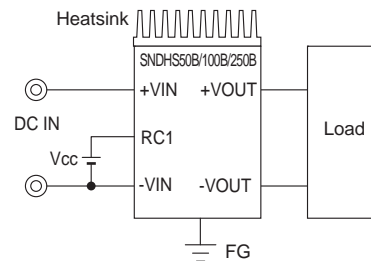

Fig.2.3 Connection 2 for standard use

■ The SNDHS Series handles only the DC input.

Avoid applying AC input directly.

It will damage the power supply.

■ Operate with the conduction cooling (e.g. heat radiation from the aluminum base plate to the attached heat sink).

[Reference: 6.2 "Derating"]

■ This power supply must be prepared another power supply to the RC1 terminal (as shown in Fig.2.3).

[Reference: 4.4 "Remote ON/OFF"]

■ If you need except SNDPG750/SNDPF1000 for the input of SNDHS50B/100B/250B, please contact us.

\* Confirm each specification and instruction manual about the SNDPG/SNDPF series.

## 3 Wiring Input/Output Terminal

### 3.1 Wiring input terminal

#### (1) External capacitor on the Input side

■When it turns on an input with a switch directly, one several times the surge voltage of input voltage occurs by the inductance ingredient of an input line, and there is a possibility that a power supply may break down.

Please install a capacitor between +VIN and -VIN input terminals and absorb surge.

$$\left\{ \begin{array}{l} \text{SNDHS50B/100B} : \text{more than } 10 \mu\text{F} \\ \text{SNDHS250B} : \text{more than } 22 \mu\text{F} \end{array} \right.$$

■When the line impedance is high or the input voltage rise quickly at start-up (less than 10 $\mu$ s), install a capacitor between +VIN and -VIN input terminals.

#### (2) Input voltage range/Input current range

■The specification of input ripple voltage is shown as below.

$$\left\{ \begin{array}{l} \text{Ripple voltage SNDHS50A/100A/200A} : \text{less than } 10\text{Vp-p} \\ \text{SNDHS50B/100B/250B} : \text{less than } 20\text{Vp-p} \end{array} \right.$$

■Make sure that the voltage fluctuation, including the ripple voltage, will not exceed the input voltage range.

■Use a front end unit with enough power, considering the start-up current  $I_p$  of this unit.

#### (3) Operation with AC input

■The SNDHS series handles only for the DC input.

A front end unit(AC/DC unit) is required when the SNDHS series is operated with AC input.

#### (4) Reverse input voltage protection

■Avoid the reverse polarity input voltage. It will break the power supply.

It is possible to protect the unit from the reverse input voltage by installing an external diode.

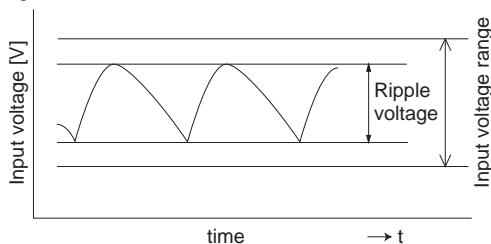

Fig.3.1 Input voltage ripple

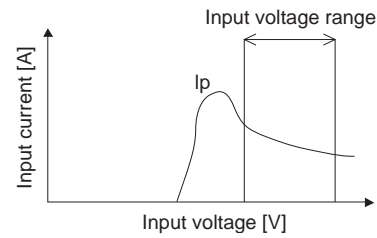

Fig.3.2 Input current characteristics

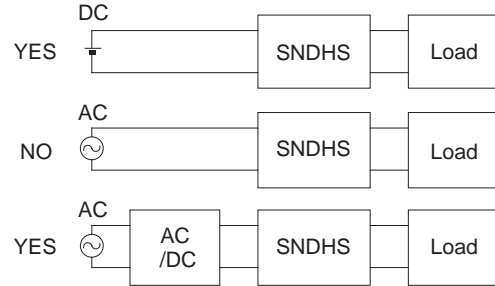

Fig.3.3 Use with AC input

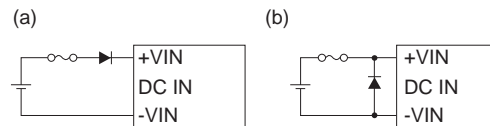
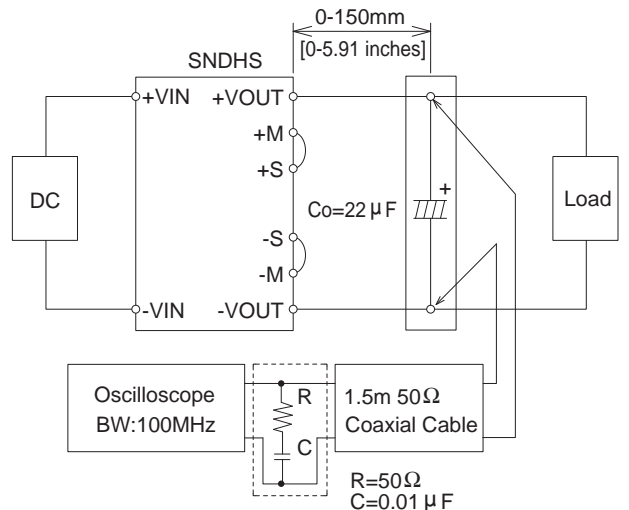

Fig.3.4 Reverse input voltage protection

### 3.2 Wiring output terminal

■The specified ripple and ripple noise are measured by the method introduced in Fig. 3.5.



+M, +S, -M, -S : SNDHS200A/SNDHS250B

Fig.3.5 Method of measuring output ripple and ripple noise

## 4 Function

### 4.1 Overcurrent protection

Over Current Protection (OCP) is built in and works at 105% of the rated current or higher. However, use in an over current situation must be avoided whenever possible. The output voltage of the power module will recover automatically if the fault causing over current is corrected.

When the output voltage drops after OCP works, the power module enters a "hiccup mode" where it repeatedly turns on and off at a certain frequency.

### 4.2 Overvoltage protection

Over Voltage Protection (OVP) is built in. When OVP works, output voltage can be recovered by shutting down DC input for at least one second or by turning off the remote control switch (secondary is an optional) for one second without shutting down the DC input. The recovery time varies according to input voltage and input capacitance.

**Remarks:**

Note that devices inside the power module may fail when a voltage greater than the rated output voltage is applied from an external power supply to the output terminal of the power module. This could happen in in-coming inspections that include OVP function test or when voltage is applied from the load circuit. OVP can be tested by using the TRM terminal. Consult us for details.

### 4.3 Thermal protection

Over Temperature Protection (OTP) is built in. If the base plate temperature exceeds 100°C, OTP will work, causing the output voltage to drop. Output voltage can be recovered by shutting down DC input for at least one second or by turning off the remote control switch (secondary is an optional) for one second without shutting down the DC input.

### 4.4 Remote ON/OFF

Please contact us about remote control of an optional.

#### ● SNDHS50B/100B/250B

This power supply must be prepared another power supply to the RC1 terminal.

The remote ON/OFF function is incorporated in the input circuit and operated with RC1 and -VIN.

Table 4.1 Remote ON/OFF specifications

Between RC1 and -VIN (Vcc)	Output Voltage
L level (0 - 1.2V) or Open	OFF
H level (3.5 - 12V)	ON

When RC1 is at High level, a current of 13mA max will sink in.

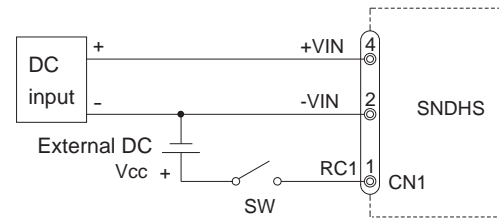

Fig. 4.1 RC1 connection example

Avoid the reverse polarity input voltage. It will break the power supply.

### 4.5 Remote sensing

#### ● SNDHS250A/SNDHS250B

(1) When Remote Sensing is Not Used

When the power supplies are shipped from a factory, they come with a dedicated short pieces being mounted on CN3 (SNDHS200A), CN4 (SNDHS250B).

If you do not use the remote sensing function, you can use the power supplies as they are.

(2) When Remote Sensing is Used

When remote sensing is used, please remove the short pieces of CN3, CN4.

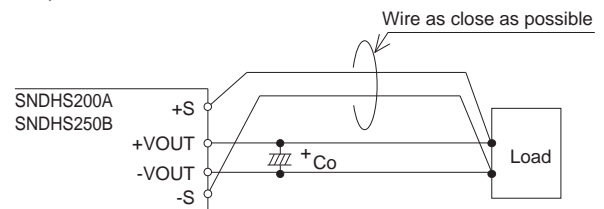

Fig. 4.2 When remote sensing is used ((SNDHS200A/SNDHS250B))

Using remote sensing with long wires may cause output voltage to become unstable. Consult us if long sensing wiring is necessary.

Sensing patterns or wires should be as short as possible. If wires are used, use either twisted-pair or shielded wires.

Use wide PCB patterns or thick wires between the power supply and the load. Line drop should be kept less than 0.3V. Make sure output voltage from the power supply stays within the specified range.

If the sensing patterns are shorted by mistake, a large current may flow and damage the pattern. This can be prevented by installing fuses or resistors close to the load.

As wiring or load impedance may generate oscillation or large fluctuations in output voltage, make sure enough evaluation is given in advance.

## 4.6 Output voltage adjusting

- Output voltage can be adjusted by internal potentiometer.  
To increase an output voltage, turn a built-in potentiometer clockwise.  
To decrease the output voltage, turn it counterclockwise.
- When the input voltage is 60-66VDC or 200-250VDC, the output voltage adjustment range becomes as shown in Fig.4.3.

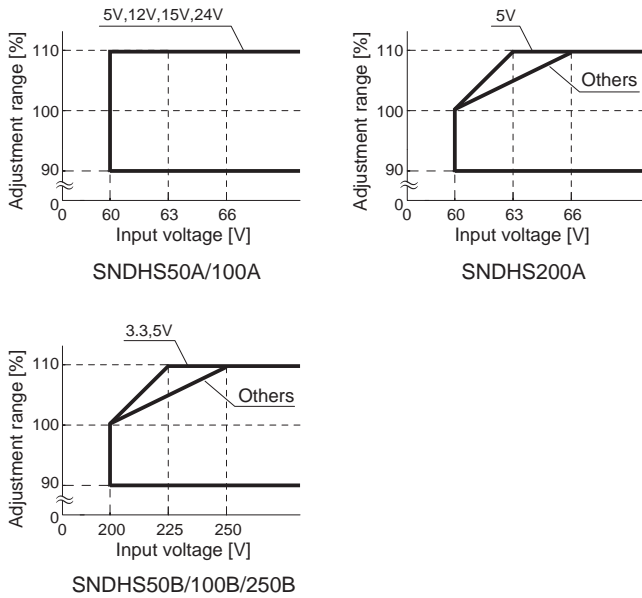

Fig. 4.3 Output voltage adjustment range

## 4.7 Withstanding voltage / Isolation voltage

- When testing the withstanding voltage, make sure the voltage is increased gradually. When turning off, reduce the voltage gradually by using the dial of the hi-pot tester. Do not use a voltage tester with a timer as it may generate voltage several times as large as the applied voltage.

# 5 Series and Parallel Operation

## 5.1 Series operation

- Series operation is available by connecting the outputs of two or more power supplies, as shown below. Output current in series connection should be lower than the lowest rated current in each unit.

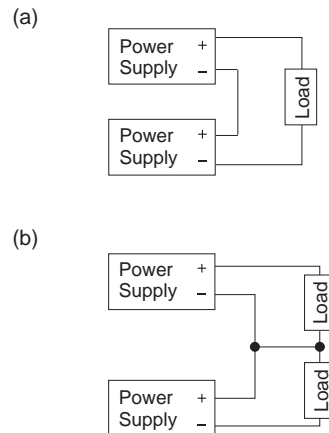

Fig. 5.1 Examples of series operation

## 5.2 Redundancy operation

- Parallel operation is not possible.
- Redundancy operation is available by wiring as shown below.

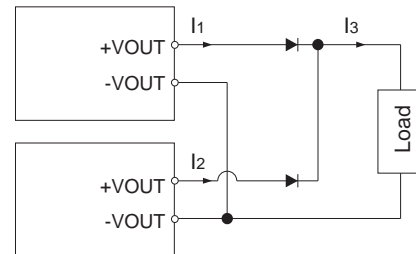

Fig. 5.2 Example of redundancy operation

- Even a slight difference in output voltage can affect the balance between the values of  $I_1$  and  $I_2$ . Please make sure that the value of  $I_3$  does not exceed the rated current of a power supply.

$$I_3 \leq \text{the rated current value}$$

# 6 Implementation · Mounting Method

## 6.1 Mounting method

- The unit can be mounted in any direction. When two or more power supplies are used side by side, position them with proper intervals to allow enough air ventilation. Aluminum base plate temperature (Point A) around each power supply should not exceed the temperature range shown in derating curve (Fig.6.2, Fig.6.4).
- In case of metal chassis, keep the distance between d1 for to insulate between lead of component and metal chassis, use the spacer of 4mm[0.16 inches] or more between d1. If it is less than d1, insert the insulation sheet between power supply and metal chassis.

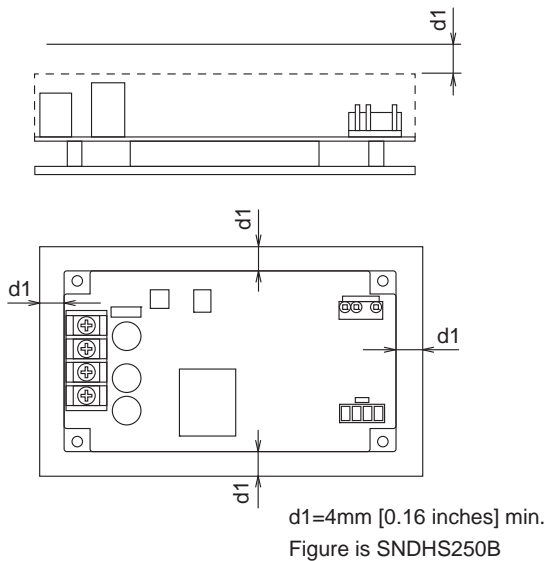

Fig.6.1 Mounting method

## 6.2 Derating

- Use with the conduction cooling (e.g. heat radiation by conduction from the aluminum base plate to the attached heat sink). Fig.6.2, Fig.6.4 shows the derating curve based on the aluminum base plate temperature. In the hatched area, the specification of Ripple and Ripple Noise is different from other areas.
- Please measure the temperature on the aluminum base plate edge side (Point A).
- Please consider the ventilation to keep the temperature on the PCB (Point B) less than the temperature of Fig.6.3., Fig.6.5.
- It is necessary to note the thermal fatigue life by power cycle. Please reduce the temperature fluctuation range as much as possible when the up and down of the temperature are frequently generated. Contact us for more information on cooling methods.

## ●SNDHS50A/100A/200A

Specifications for ripple and ripple noise changes in the shaded area.

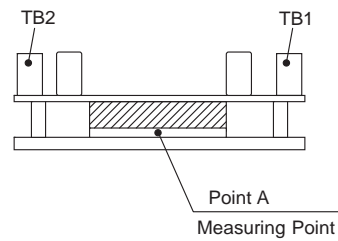
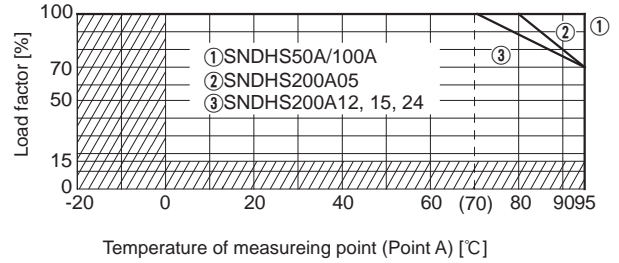

Fig.6.2 Derating curve (Point A)

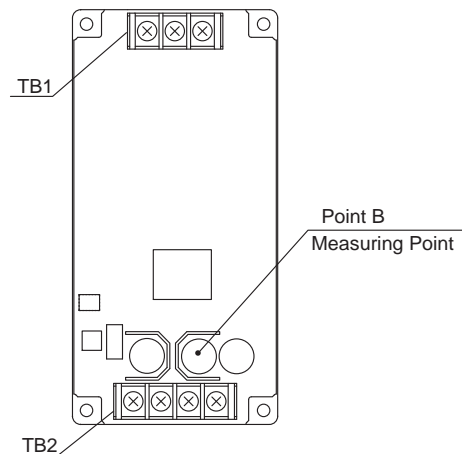
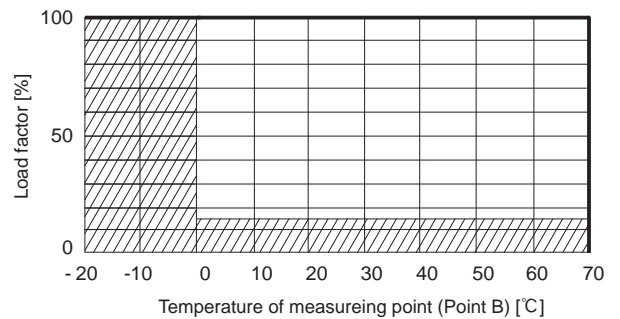

Figure is SNDHS200A

Fig.6.3 Derating curve (Point B)



## ● SNDHS50B/100B/250B

Specifications for ripple and ripple noise changes in the shaded area.

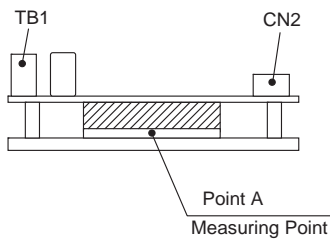
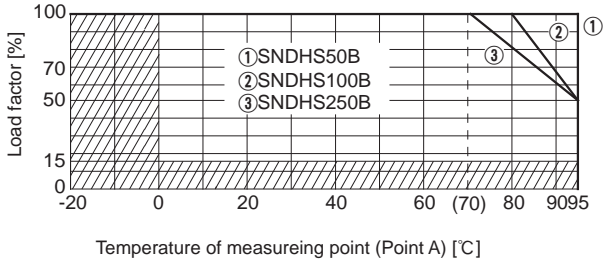

Fig.6.4 Derating curve (Point A)

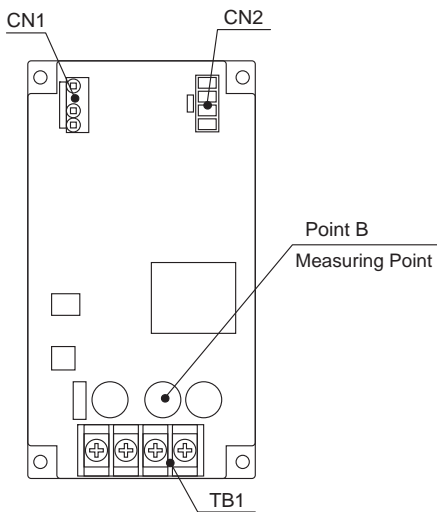
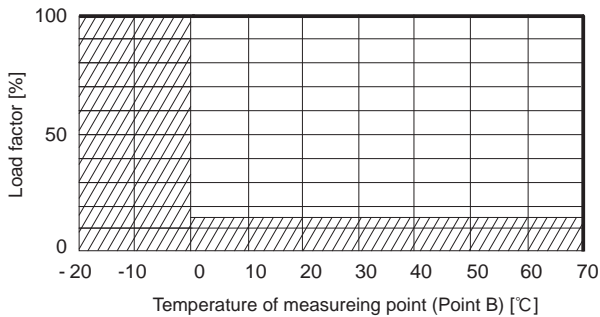

Figure is SNDHS250B

Fig.6.5 Derating curve (Point B)

## 7 Option and Others

### 7.1 Outline of option

#### ● -C

- Option -C units have coated internal PCB for better moisture resistance.

#### ● -R (SNDHS50A, SNDHA100A, SNDHS200A)

- You can control output ON/OFF remotely in Option -R units. To do so, connect an external DC power supply and apply a voltage to a remote ON/OFF connector, which is available as option.

Model Name	Built-in Resistor Ri [Ω]	Voltage between +RC and -RC [V]		Input Current [mA]
		ENA ON	ENA OFF	
SNDHS50A, SNDHS100A, SNDHS200A	1200	3.5 - 12	0 - 0.5	10max

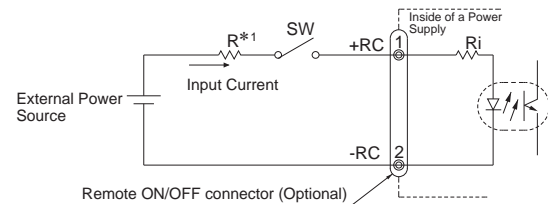

Fig.7.1 Example of using a remote ON/OFF circuit

- Dedicated harnesses are available for your purchase. Please see Optional Parts for details.

\*1 If the output of an external power supply is within the range of 3.5 - 12V, you do not need a current limiting resistor R. If the output exceeds 12V, however, please connect the current limiting resistor R.

To calculate a current limiting resistance value, please use the following equation.

$$R[\Omega] = \frac{V_{CC} - (1.1 + R_i \times 0.005)}{0.005}$$

\*Please wire carefully. If you wire wrongly, the internal components of a unit may be damaged.

■ Remote ON/OFF circuits (+RC and -RC) are isolated from input, output and FG.

● -R (SNDHS50B, SNDHA100B, SNDHS250B)

- The output can be turned on without external power source.
- When short circuit piece is not mounted on RC3, various remote control is available.

Case 1: When short circuit piece is mounted on RC3, the output can be turned on by applying input voltage (external power source to the remote control circuit is unnecessary). When the power supplies are shipped from a factory, they come with a dedicated short circuit piece mounted on RC3.

Case 2: When short circuit piece is mounted on RC3, the output (ON/OFF) can be controlled by making open/short RC3.

Case 3: When short circuit piece is not mounted on RC3, the output (ON/OFF) can be controlled by external power source to remote control circuit RC1 and RC2.

CASE	RC3 SHORT CIRCUIT PIECE	RC3	RC1 DC VOLTAGE	RC2 DC VOLTAGE	OUTPUT	OUTSIDE OF POWER SUPPLY	INSIDE OF POWER SUPPLY
1	mounted	Short	-	-	ON		
2	not mounted	Short	1.2[V] or less	0.5[V] or less	ON		
		Open			OFF		
3	not mounted	Open	3.5 ~ 12[V]	3.5 ~ 12[V]	ON		
				0.5[V] or less	OFF		

Fig.7.2 Example of using a remote ON/OFF circuit.

- Dedicated harnesses are available for your purchase. Please see Optional Parts for details.

\*1 If the output of an external power supply is within the range of 3.5 - 12V, you do not need a current limiting resistor R1, R2. If the output exceeds 12V, however, please connect the current limiting resistor R1, R2.

To calculate a current limiting resistance value, please use the following equation.

$$R1, R2[\Omega] = \frac{V_{cc} - (1.1 + R_{i1}, R_{i2} \times 0.005)}{0.005}$$

\*Please wire carefully. If you wire wrongly, the internal components of a unit may be damaged.

■ Remote ON/OFF circuits (+RC2 and -RC2 only) are isolated from input, output and FG.