

Sup/IRBuck™

USER GUIDE FOR IR3820 EVALUATION BOARD

DESCRIPTION

The IR3820 is a synchronous buck converter, providing a compact, high performance and flexible solution in a small 5mmx6mm Power QFN package.

Key features offered by the IR3820 include programmable soft-start ramp, precision 0.6V reference voltage, programmable Power Good, thermal protection, fixed 600kHz switching frequency requiring no external component, input under-voltage lockout for proper start-up, and pre-bias start-up.

An output over-current protection function is implemented by sensing the voltage developed across the on-resistance of the synchronous rectifier MOSFET for optimum cost and performance.

This user guide contains the schematic and bill of materials for the IR3820 evaluation board. The guide describes operation and use of the evaluation board itself. Detailed application information for the IR3820 is available in the IR3820 data sheet.

BOARD FEATURES

- $V_{in} = +12V$ (13.2V Max)
- $V_{out} = +1.8V @ 0- 12A$
- $L = 0.6\mu H$
- $C_{in} = 3 \times 10\mu F$ (ceramic 1206) + $1 \times 330\mu F$ (Electrolytic)
- $C_{out} = 6 \times 22\mu F$ (ceramic 0805)

CONNECTIONS and OPERATING INSTRUCTIONS

A well regulated +12V input supply should be connected to VIN+ and VIN-. A maximum 12A load should be connected to VOUT+ and VOUT-. The connection diagram is shown in Fig. 1 and inputs and outputs of the board are listed in Table I.

IR3820 has two input supplies, one for biasing (Vcc) and the other as input voltage (Vin). These inputs are connected on the board with a zero ohm resistor (R15). Separate supplies can be applied to these inputs. Vcc input cannot be connected unless R15 is removed. Vcc input should be a well regulated 5V-12V supply and it would be connected to Vcc+ and Vcc-.

Table I. Connections

Connection	Signal Name
VIN+	V_{in} (+12V)
VIN-	Ground of V_{in}
Vcc+	Optional Vcc input
Vcc-	Ground for Optional Vcc input
VOUT-	Ground of V_{out}
VOUT+	V_{out} (+1.8V)
P_Good	Power Good Signal

LAYOUT

The PCB is a 4-layer board. All of layers are 2 Oz. copper. IR3820 and all of the passive components are mounted on the top side of the board.

Power supply decoupling capacitors, the charge-pump capacitor and feedback components are located close to IR3820. The feedback resistors are connected to the output voltage at the point of regulation and are located close to IR3820.

To improve efficiency, the circuit board is designed to minimize the length of the on-board power ground current path.

Connection Diagram

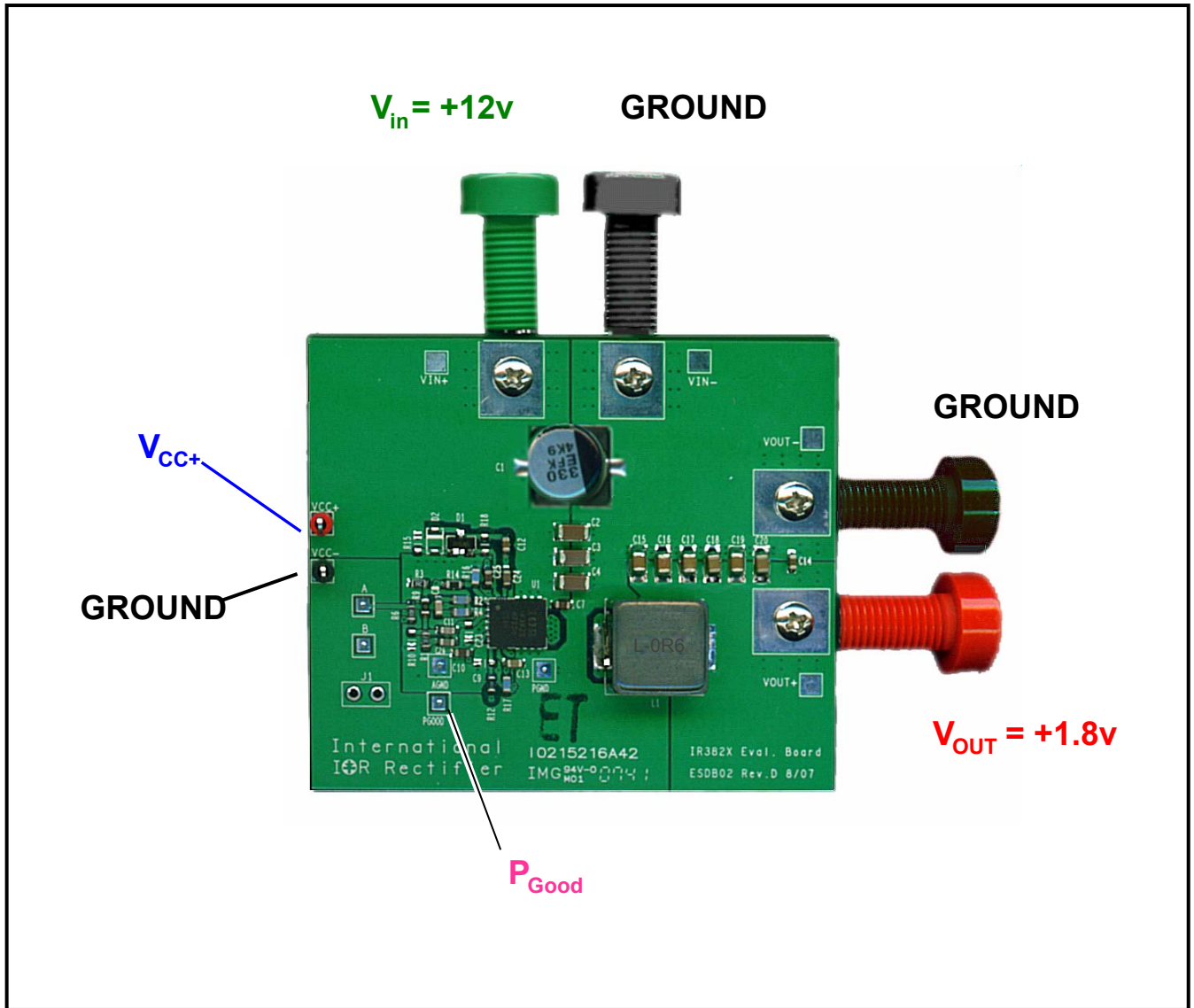

Fig. 1: Connection diagram of IR3820 evaluation board

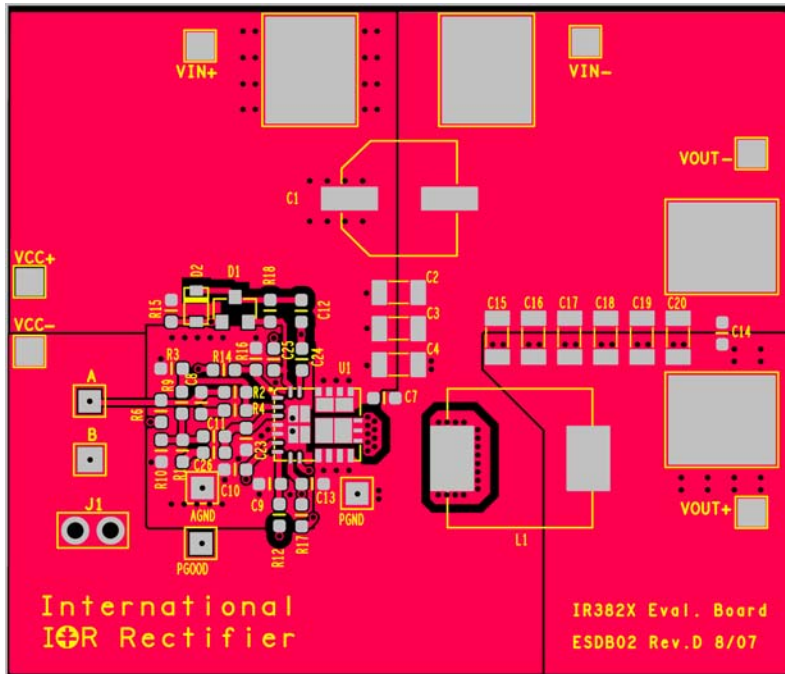

Fig. 2: Board layout, top overlay

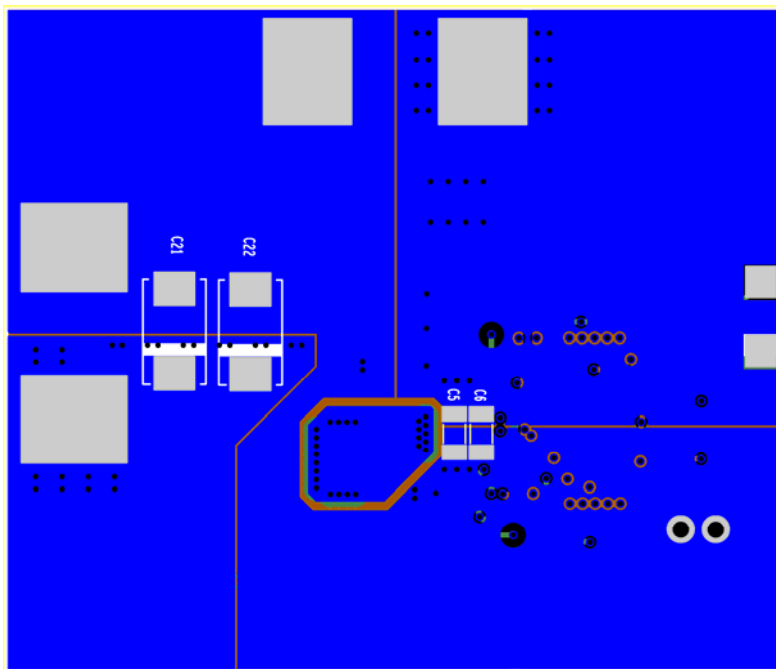

Fig. 3: Board layout, bottom overlay (rear view)

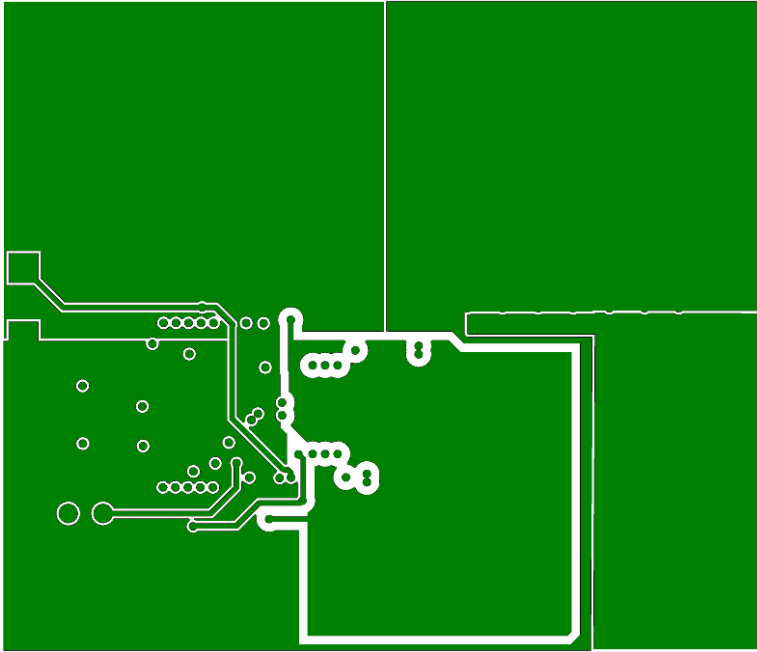

Fig. 4: Board layout, mid-layer I.

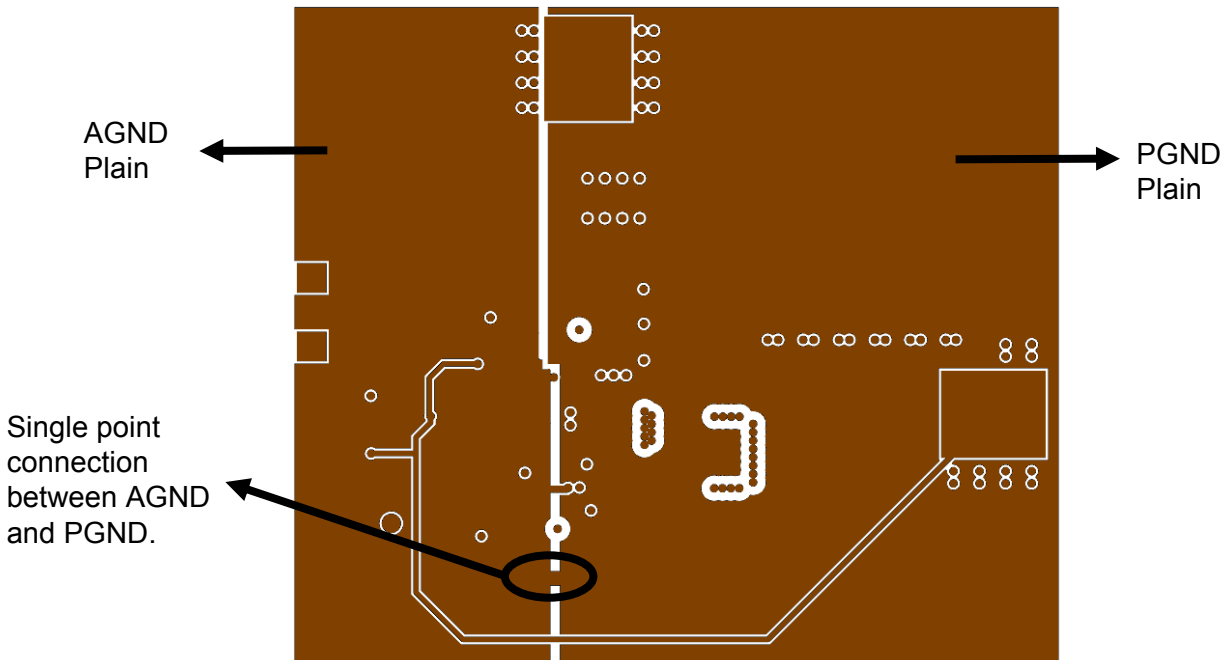
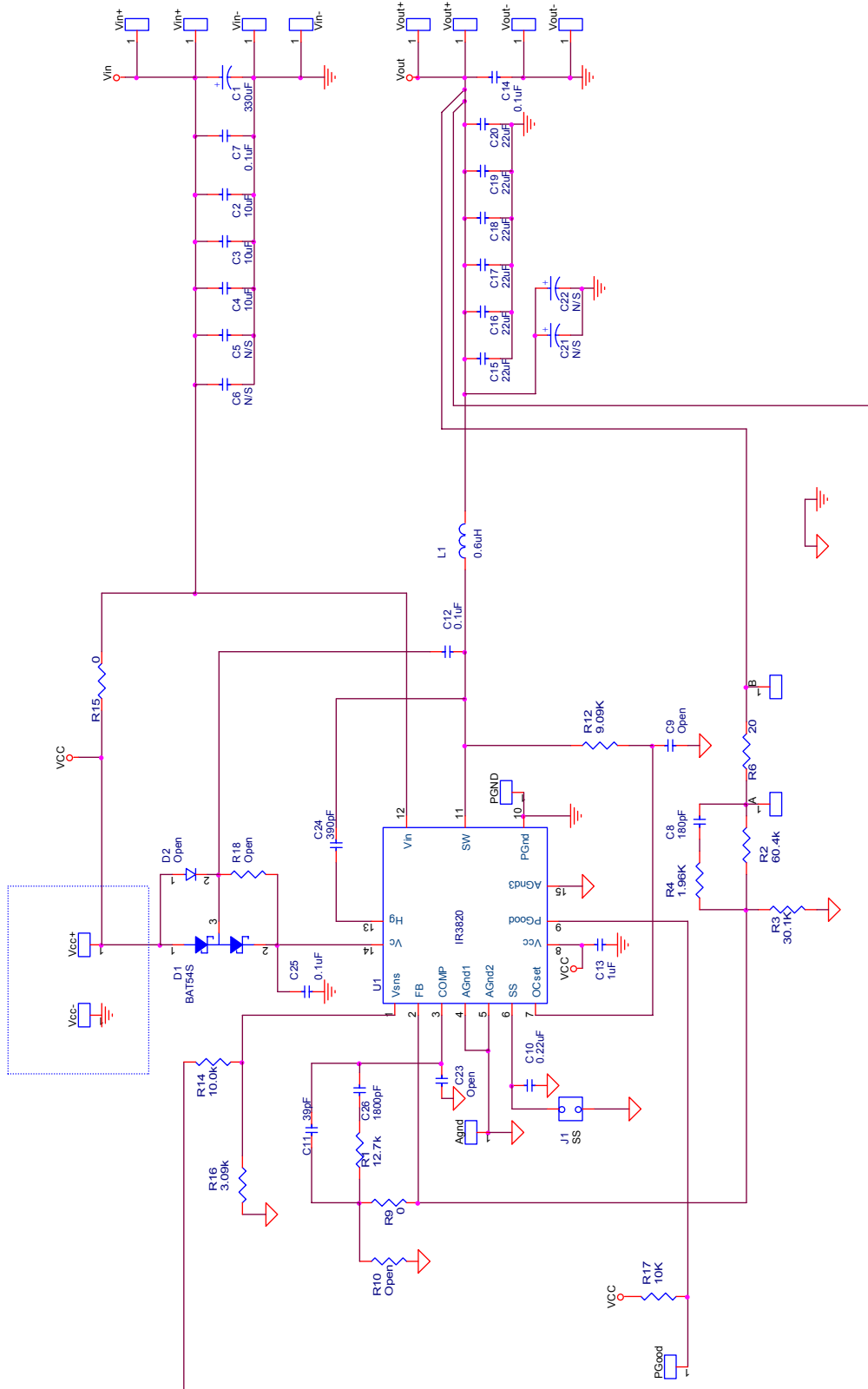

Fig. 5: Board layout, mid-layer II.



Single point of connection between Power
 Ground and Signal ("analog") Ground

Fig. 6: Schematic of the IR3820 evaluation board

Bill of Materials

Item	Quantity	Designator	Value	Description	Size	Manufacturer	Mfr. Part Number
1	1	C1	330uF	SMD Electrolytic, 25V, 20%	SMD	Panasonic	EEV-FK1E331P
2	3	C2 C3 C4	10uF	Ceramic, 16V, X7R, 10%	1206	Panasonic	ECJ-3YX1C106K
3	4	C7 C12 C14 C25	0.1uF	Ceramic, 50V, X7R, 10%	0603	Panasonic	ECJ-1VB1H104K
4	1	C10	0.22uF	Ceramic, 10V, X5R, 10%	0603	Panasonic	ECJ-1VB1A224K
5	1	C8	180pF	Ceramic, 50V, NPO, 5%	0603	Murata	GRM1885C1H181JA01
6	1	C11	39pF	Ceramic, 50V, NPO, 5%	0603	Murata	GRM1885C1H390JA01
7	1	C13	1uF	Ceramic, 16V, X5R, 10%	0603	Panasonic	ECJ-1VB1C105K
8	6	C15 C16 C17 C18 C19 C20	22uF	Ceramic, 6.3V, X5R, 20%	0805	Panasonic	ECJ-2FB0J226M
9	1	C24	390pF	Ceramic, 50V, NPO, 5%	0603	Murata	GRM1885C1H391JA01
10	1	C26	1800pF	Ceramic, 50V, NPO, 5%	0603	Murata	GRM1885C1H182JA01
11	1	D1	BAT54S	Diode Schottky ,40V, 200mA	SOT-23	Fairchild	BAT54S
12	1	L1	0.6uH	SMT Inductor, 1.7mOhm, 20%	11.5x10mm	Delta	MPL104-0R6
13	1	R1	12.7K	Thick film, 1/10W, 1%	0603	Vishey/Dale	CRCW060312K7FKEA
14	1	R3	30.1K	Thick film, 1/10W, 1%	0603	Vishey/Dale	CRCW060330K1FKEA
15	1	R2	60.4K	Thick film, 1/10W, 1%	0603	Vishey/Dale	CRCW060360K4FKEA
16	1	R4	1.96K	Thick film, 1/10W, 1%	0603	Vishey/Dale	CRCW06031K96FKEA
17	1	R6	20	Thick film, 1/10W, 1%	0603	Vishey/Dale	CRCW060320R0FKEA
18	2	R9 R15	0	Thick film, 1/10W, 1%	0603	Vishey/Dale	CRCW06030000Z0EA
19	1	R12	9.09K	Thick film, 1/10W, 1%	0603	Vishey/Dale	CRCW06039K09FKEA
20	2	R14, R17	10K	Thick film, 1/10W, 1%	0603	Vishey/Dale	CRCW060310K0FKEA
21	1	R16	3.09K	Thick film, 1/10W, 1%	0603	Vishey/Dale	CRCW06033K09FKEA
22	1	U1	IR3820	600kHz, 12A, SupIRBuck Module	5x6mm	International Rectifier	IR3820
23	2	-	-	Banana Jack, Insulated Solder Terminal, Black	-	Johnson Components	105-0853-001
24	1	-	-	Banana Jack, Insulated Solder Terminal, Red	-	Johnson Components	105-0852-001
25	1	-	-	Banana Jack, Insulated Solder Terminal, Green	-	Johnson Components	105-0854-001

TYPICAL OPERATING WAVEFORMS

$V_{in}=V_{cc}=12.0V$, $V_o=1.8V$, $I_o=0-12A$, Room Temperature, No Air Flow

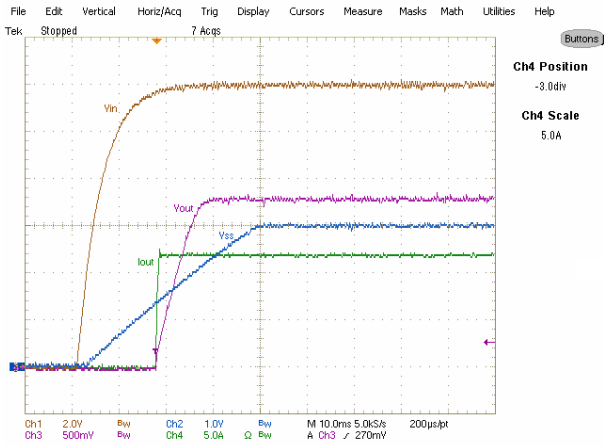

Fig. 7: Start up at 12A Load
Ch₁: V_{in} , Ch₂: V_{SS} , Ch₃: V_{out} , Ch₄: I_{out}

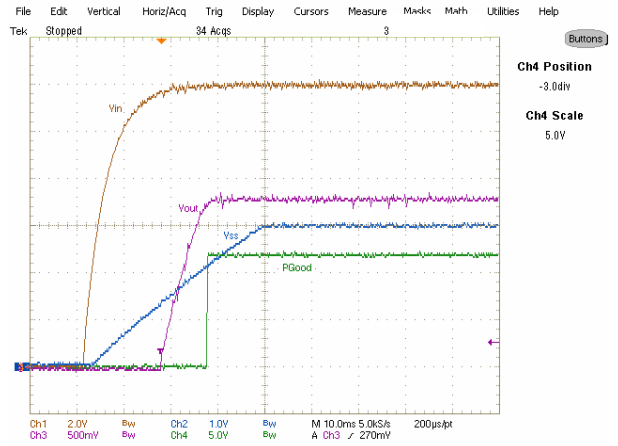

Fig. 8: Start up at 12A Load,
Ch₁: V_{in} , Ch₂: V_{SS} , Ch₃: V_{out} , Ch₄: V_{PGood}

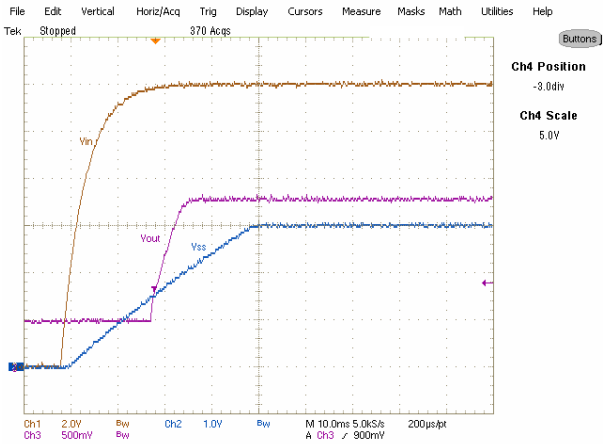

Fig. 9: Pre-Bias Start up, 0A Load
Ch₁: V_{in} , Ch₂: V_{SS} , Ch₃: V_{out}

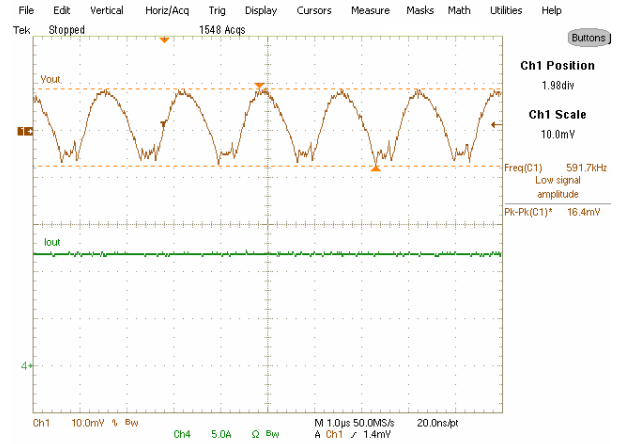

Fig. 10: Output Voltage Ripple, 12A load
Ch₁: V_{out} , Ch₄: I_{out}

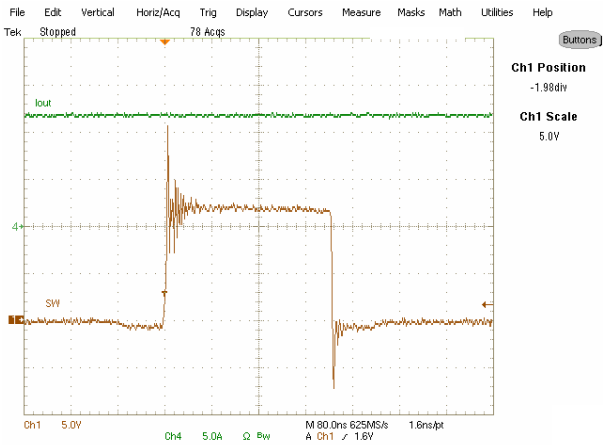

Fig. 11: Inductor node at 12A load
Ch₁: I_{LX} , Ch₄: I_{out}

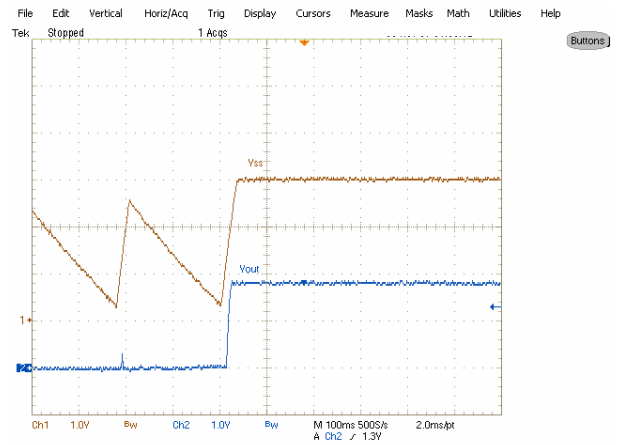

Fig. 12: Short (Hiccup) Recovery
Ch₁: V_{SS} , Ch₂: V_{out}

TYPICAL OPERATING WAVEFORMS

$V_{in}=V_{cc}=12V$, $V_o=1.8V$, $I_o=6A-12A$, Room Temperature, No Air Flow

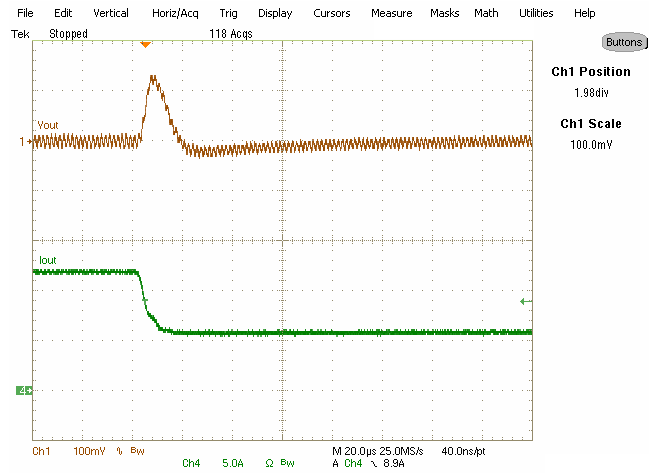
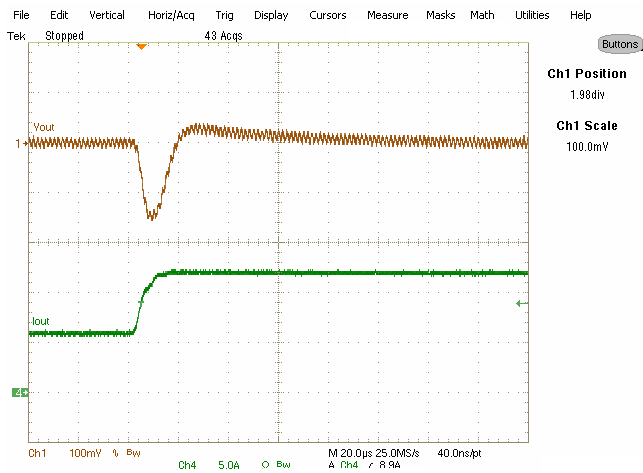
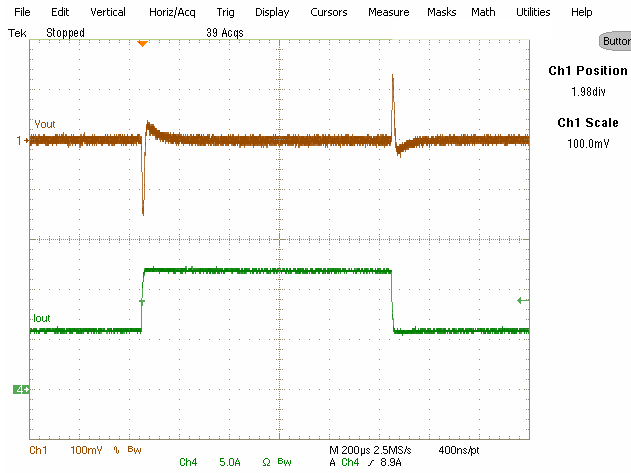

Fig. 13: Transient Response, 6A to 12A step

Ch₁:V_{out}, Ch₄:I_{out}

TYPICAL OPERATING WAVEFORMS

Vin=Vcc=12V, Vo=1.8V, Io=12A, Room Temperature, No Air Flow

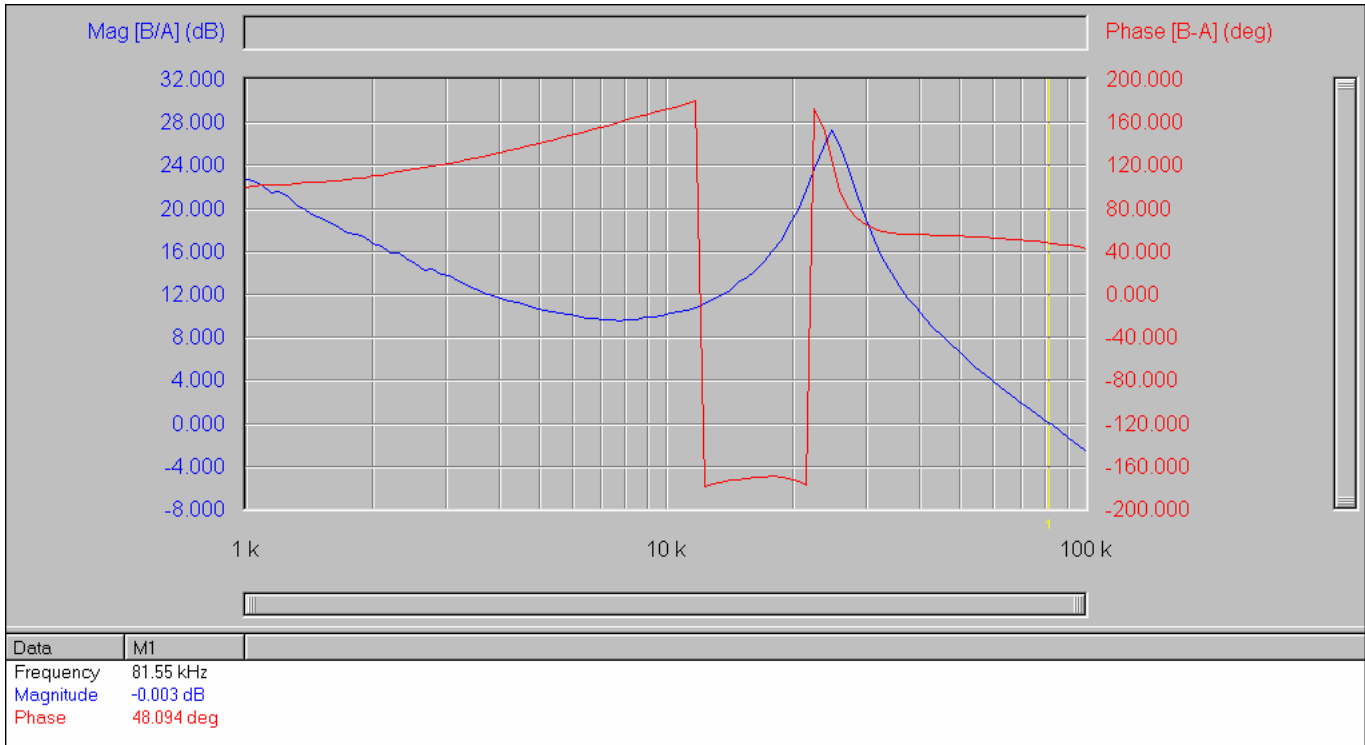

Fig. 14: Bode Plot at 12A load shows a bandwidth of 82kHz and phase margin of 48 degrees

TYPICAL OPERATING WAVEFORMS

Vin=12V, Vo=1.8V, Io=0- 12A, Room Temperature, No Air Flow

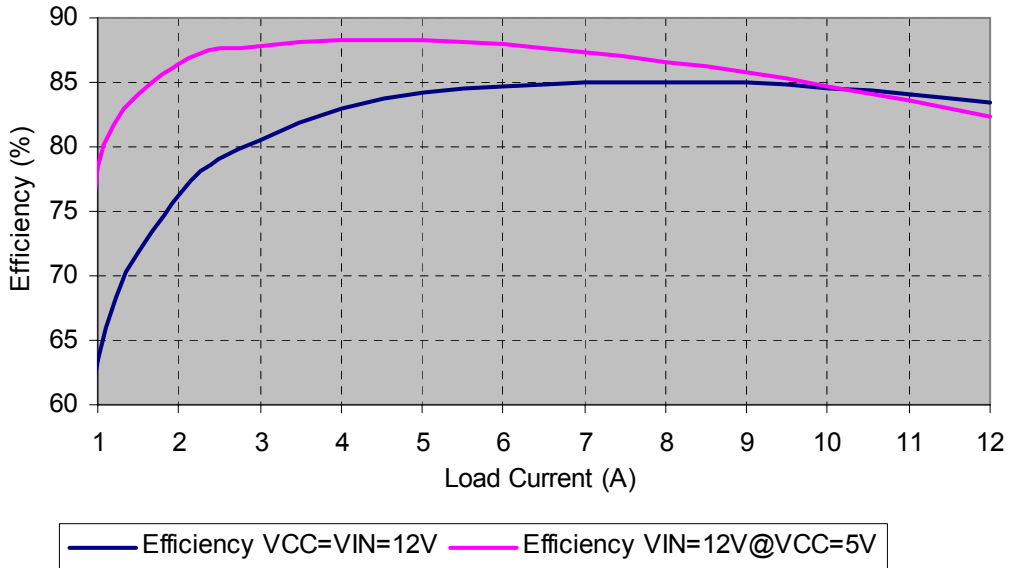

Fig.15: Efficiency versus load current

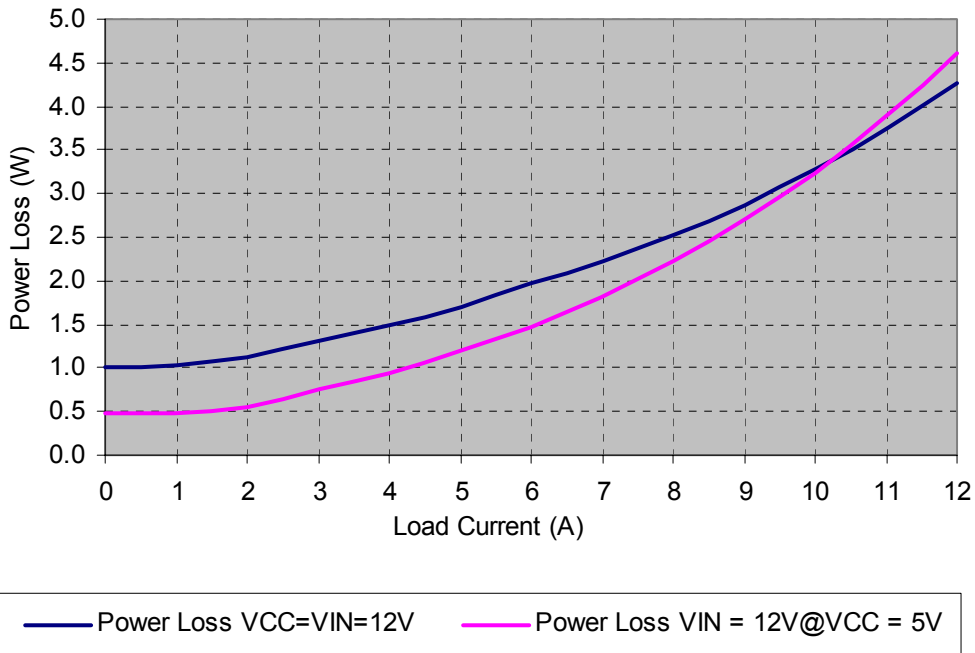

Fig.16: Power loss versus load current

THERMAL IMAGES

Vin=Vcc=12V, Vo=1.8V, Io=12A, Room Temperature, 200LFM

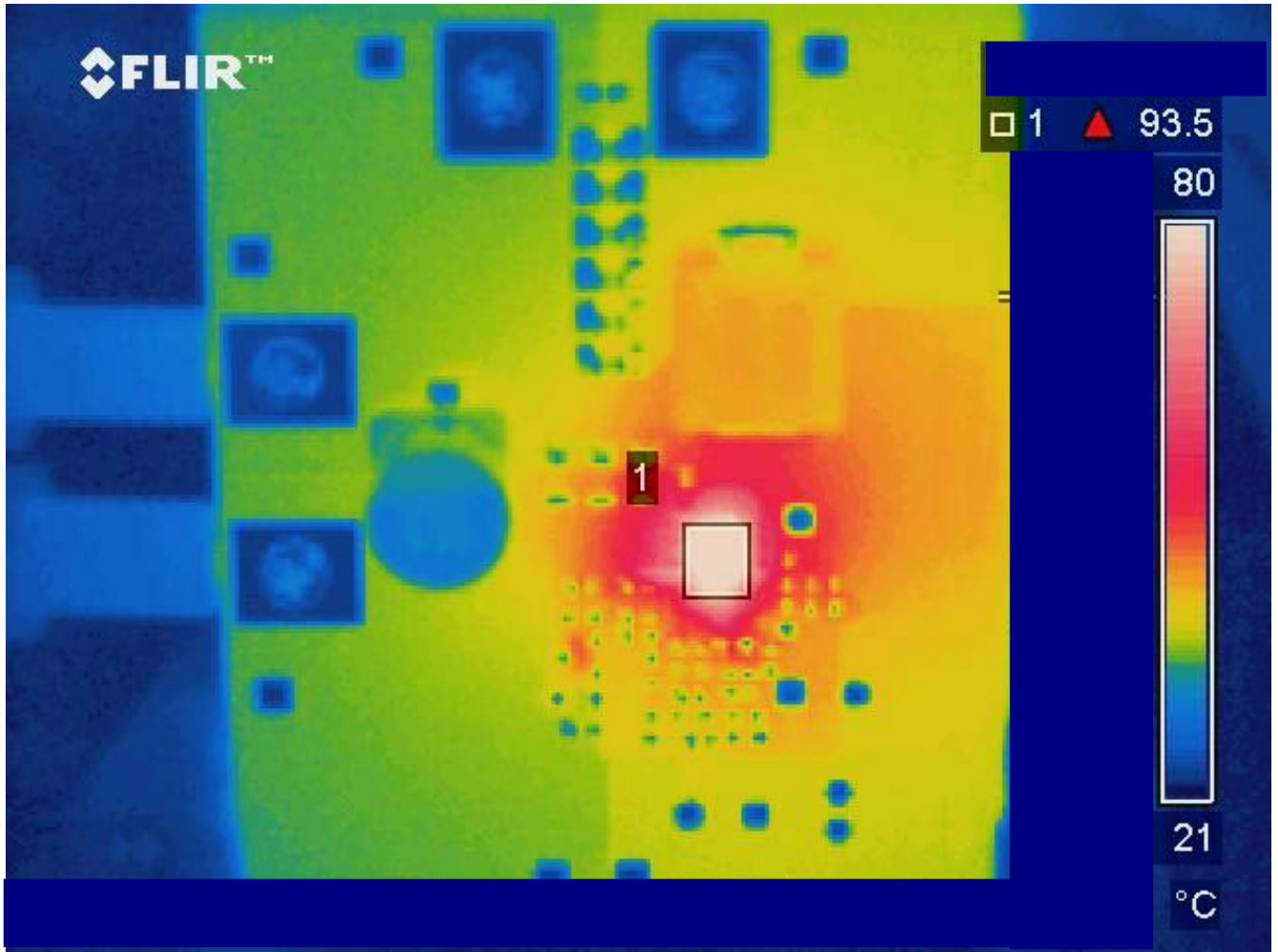

Fig. 17: Thermal Image at 12A load
Test point 1 is the IR3820

PCB Metal and Components Placement

The lead lands (the 11 IC pins) width should be equal to the nominal part lead width. The minimum lead to lead spacing should be $\geq 0.2\text{mm}$ to minimize shorting.

Lead land length should be equal to the maximum part lead length + 0.3 mm outboard extension. The outboard extension ensures a large and inspectable toe fillet.

The pad lands (the 4 big pads other than the 11 IC pins) length and width should be equal to maximum part pad length and width. However, the minimum metal to metal spacing should be no less than 0.17mm for 2 oz. Copper; no less than 0.1mm for 1 oz. Copper and no less than 0.23mm for 3 oz. Copper.

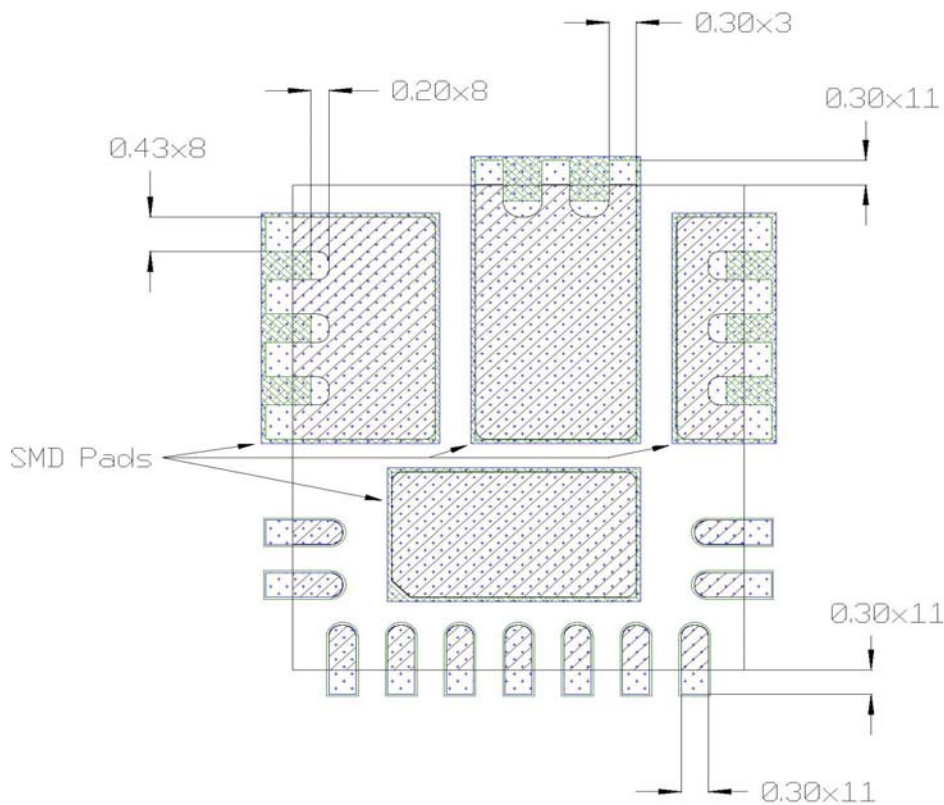

All Dimensions in mm

-  PCB Copper
-  Component pad
-  Soldermask

Solder Resist

It is recommended that the lead lands are Non Solder Mask Defined (NSMD). The solder resist should be pulled away from the metal lead lands by a minimum of 0.025mm to ensure NSMD pads.

The land pad should be Solder Mask Defined (SMD), with a minimum overlap of the solder resist onto the copper of 0.05mm to accommodate solder resist mis-alignment.

Ensure that the solder resist in between the lead lands and the pad land is $\geq 0.15\text{mm}$ due to the high aspect ratio of the solder resist strip separating the lead lands from the pad land.

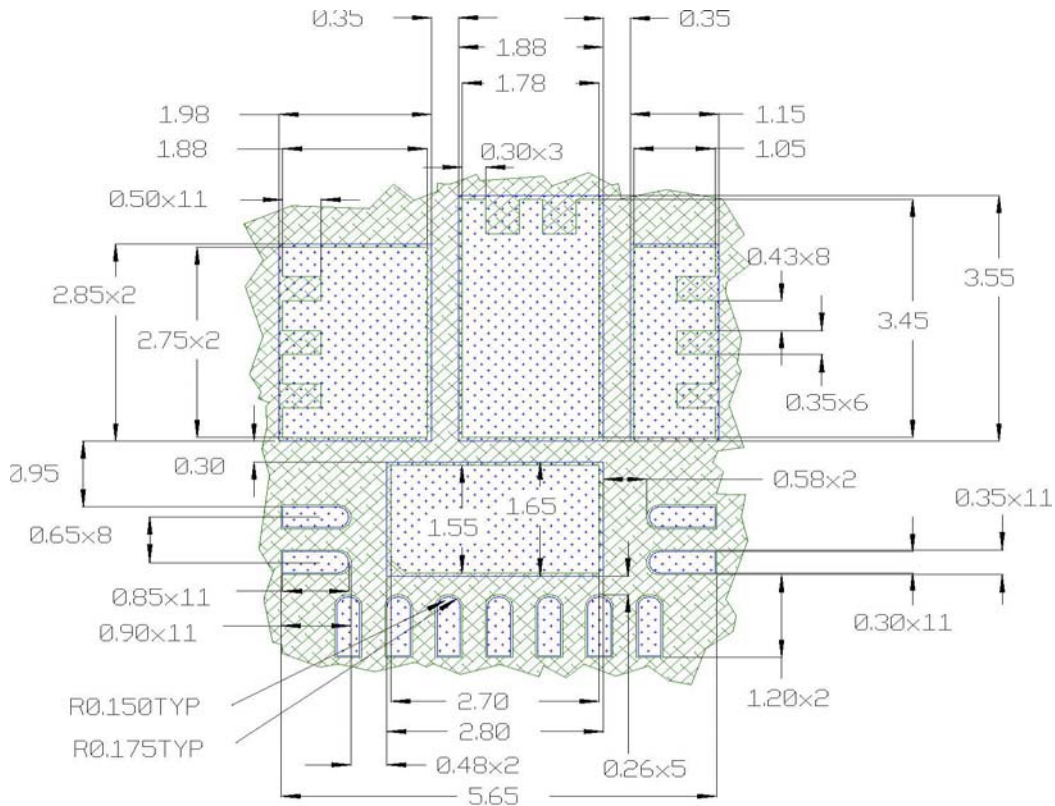

All Dimensions in mm

- PCB Copper
- PCB Solder Resist

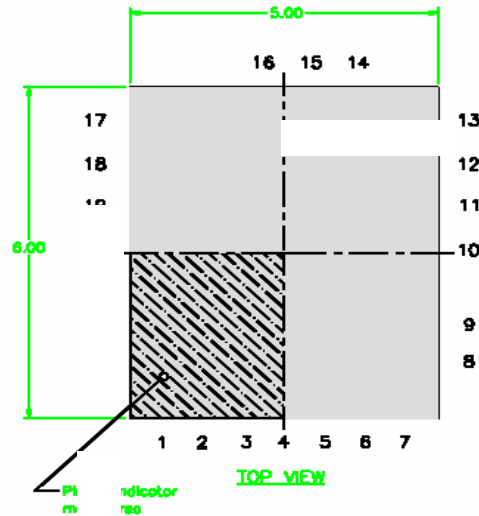
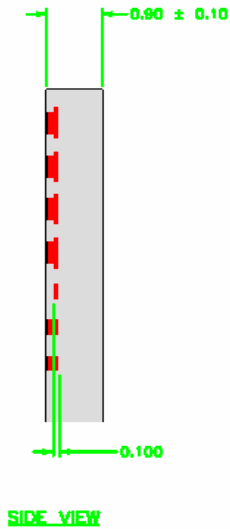
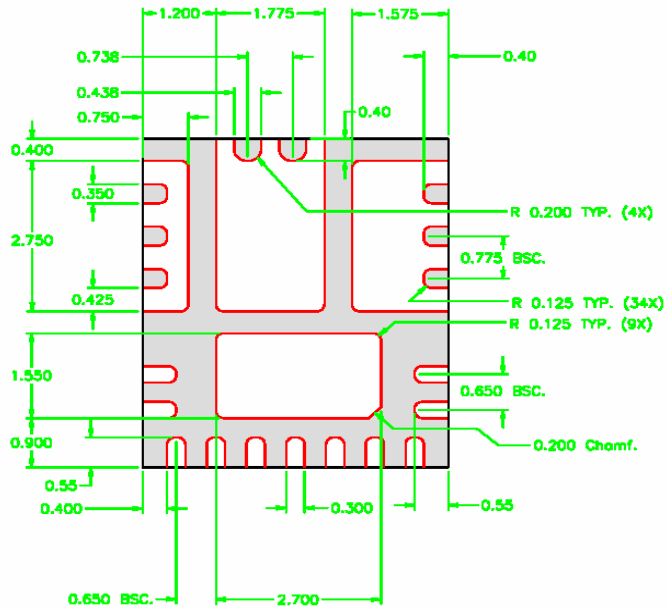

UNLESS OTHERWISE SPECIFIED
 DIMENSIONS ARE IN MILLIMETERS

DECIMAL	ANGULAR
X.X ±	±1°
X.XX ±	±0.10
X.XXX ±	±0.050