

Fast Recovery Diodes (Hockey PUK Version), 920/1050 A



DO-200AB (B-PUK)

FEATURES

- High power fast recovery diode series
- 2.0 μ s to 3.0 μ s recovery time
- High voltage ratings up to 3000 V
- High current capability
- Optimized turn-on and turn-off characteristics
- Low forward recovery
- Fast and soft reverse recovery
- Press PUK encapsulation
- Case style conform to JEDEC® DO-200AB (B-PUK)
- Maximum junction temperature 150 °C
- Designed and qualified for industrial level
- Material categorization: for definitions of compliance please see www.vishay.com/doc?99912



RoHS
COMPLIANT

PRODUCT SUMMARY

$I_{F(AV)}$	920 A to 1050 A
Package	DO-200AB (B-PUK)
Circuit configuration	Single diode

TYPICAL APPLICATIONS

- Snubber diode for GTO
- High voltage freewheeling diode
- Fast recovery rectifier applications

MAJOR RATINGS AND CHARACTERISTICS

PARAMETER	TEST CONDITIONS	SD1053C..L		UNITS
		S20	S30	
$I_{F(AV)}$		1050	920	A
	T_{hs}	55	55	°C
$I_{F(RMS)}$		1940	1700	A
I_{FSM}	50 Hz	15 000	13 000	
	60 Hz	15 700	13 610	
V_{RRM}	Range	1800 to 2500	1800 to 3000	V
t_{rr}		2.0	3.0	μ s
	T_J	25		°C
T_J	-40 to +150			

ELECTRICAL SPECIFICATIONS
VOLTAGE RATINGS

TYPE NUMBER	VOLTAGE CODE	V_{RRM} , MAXIMUM REPETITIVE PEAK REVERSE VOLTAGE V	V_{RSM} , MAXIMUM NON-REPETITIVE PEAK REVERSE VOLTAGE V	I_{RRM} MAXIMUM AT $T_J = T_J$ MAXIMUM mA
VS-SD1053C..S20L	18	1800	1900	50
	22	2200	2300	
	24	2400	2500	
	25	2500	2600	
VS-SD1053C..S30L	18	1800	1900	
	22	2200	2300	
	25	2500	2600	
	28	2800	2900	
	30	3000	3100	



FORWARD CONDUCTION							
PARAMETER	SYMBOL	TEST CONDITIONS		SD1053C..L		UNITS	
				S20	S30		
Maximum average forward current at heatsink temperature	$I_{F(AV)}$	180° conduction, half sine wave Double side (single side) cooled		1050 (450)	920 (390)	A	
Maximum RMS forward current	$I_{F(RMS)}$	25 °C heatsink temperature double side cooled		1940	1700	°C	
Maximum peak, one-cycle forward, non-repetitive surge current	I_{FSM}	t = 10 ms	No voltage reappplied	Sinusoidal half wave, initial $T_J = T_J$ maximum	15 000	13 000	A
		t = 8.3 ms			15 700	13 610	
		t = 10 ms	100 % V_{RRM} reappplied		12 620	10 930	
		t = 8.3 ms			13 210	11 450	
Maximum I^2t for fusing	I^2t	t = 10 ms	No voltage reappplied		1125	845	kA ² s
		t = 8.3 ms			1027	772	
		t = 10 ms	100 % V_{RRM} reappplied		796	598	
		t = 8.3 ms			727	546	
Maximum $I^2\sqrt{t}$ for fusing	$I^2\sqrt{t}$	t = 0.1 to 10 ms, no voltage reappplied		11 250	8450	kA ² √s	
Low level value of threshold voltage	$V_{F(TO)1}$	$(16.7 \% \times \pi \times I_{F(AV)} < I < \pi \times I_{F(AV)})$, $T_J = T_J$ maximum		1.34	1.51	V	
High level value of threshold voltage	$V_{F(TO)2}$	$(I > \pi \times I_{F(AV)})$, $T_J = T_J$ maximum		1.48	1.67		
Low level value of forward slope resistance	r_{f1}	$(16.7 \% \times \pi \times I_{F(AV)} < I < \pi \times I_{F(AV)})$, $T_J = T_J$ maximum		0.37	0.50	mΩ	
High level value of forward slope resistance	r_{f2}	$(I > \pi \times I_{F(AV)})$, $T_J = T_J$ maximum		0.33	0.45		
Maximum forward voltage drop	V_{FM}	$I_{pk} = 1500$ A, $T_J = T_J$ maximum, $t_p = 10$ ms sinusoidal wave		1.90	2.26	V	

RECOVERY CHARACTERISTICS								
CODE	MAXIMUM VALUE AT $T_J = 25$ °C	TEST CONDITIONS			TYPICAL VALUES AT $T_J = 150$ °C			
	t_{rr} AT 25 % I_{RRM} (μs)	I_{pk} SQUARE PULSE (A)	dI/dt (A/μs)	V_r (V)	t_{rr} AT 25 % I_{RRM} (μs)	Q_{rr} (μC)	I_{rr} (A)	
S20	2.0	1000	100	- 50	4.0	400	180	
S30	3.0				4.5	550	230	

THERMAL AND MECHANICAL SPECIFICATIONS				
PARAMETER	SYMBOL	TEST CONDITIONS	VALUES	UNITS
Maximum junction operating and storage temperature range	T_J, T_{Stg}		-40 to 150	°C
Maximum thermal resistance, case junction to heatsink	R_{thJ-hs}	DC operation single side cooled	0.073	K/W
		DC operation double side cooled	0.031	
Mounting force, ± 10 %			14 700 (1500)	N (kg)
Approximate weight			255	g
Case style		See dimensions - link at the end of datasheet	DO-200AB (B-PUK)	

ΔR_{thJ-hs} CONDUCTION						
CONDUCTION ANGLE	SINUSOIDAL CONDUCTION		RECTANGULAR CONDUCTION		TEST CONDITIONS	UNITS
	SINGLE SIDE	DOUBLE SIDE	SINGLE SIDE	DOUBLE SIDE		
180°	0.009	0.008	0.006	0.006	$T_J = T_J$ maximum	K/W
120°	0.011	0.011	0.011	0.011		
90°	0.014	0.014	0.015	0.015		
60°	0.020	0.021	0.021	0.022		
30°	0.036	0.036	0.036	0.036		

Note

- The table above shows the increment of thermal resistance R_{thJ-hs} when devices operate at different conduction angles than DC

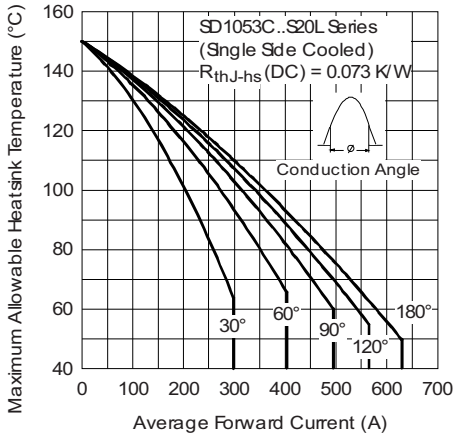

Fig. 1 - Current Ratings Characteristics

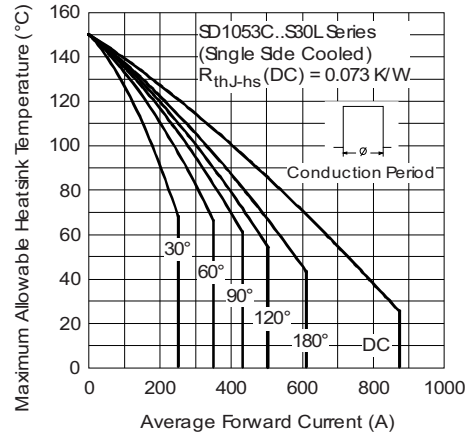

Fig. 4 - Current Ratings Characteristics

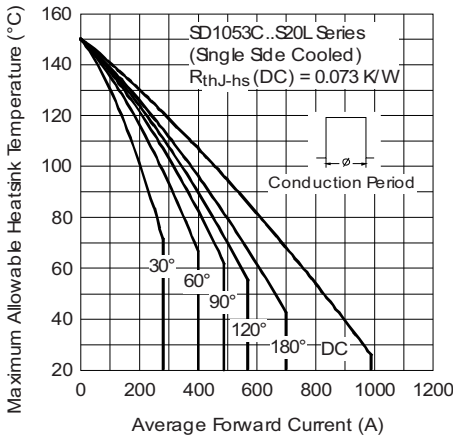

Fig. 2 - Current Ratings Characteristics

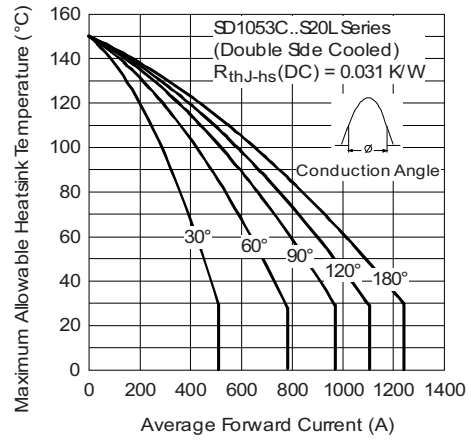

Fig. 5 - Current Ratings Characteristics

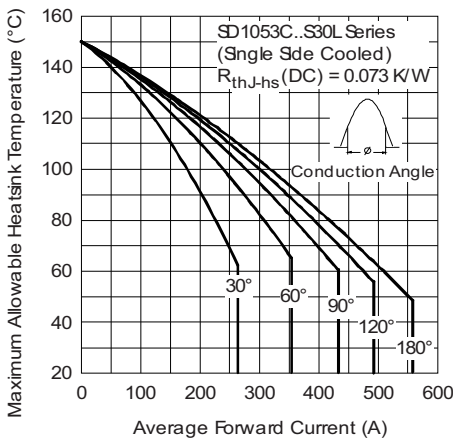

Fig. 3 - Current Ratings Characteristics

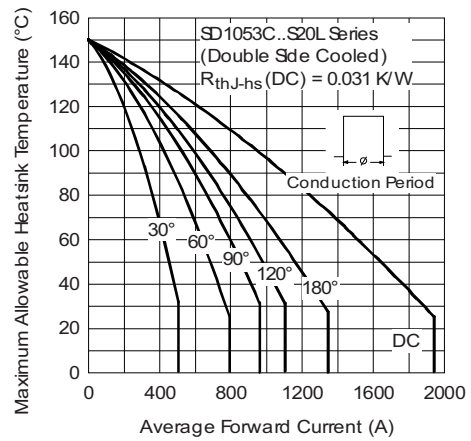

Fig. 6 - Current Ratings Characteristics

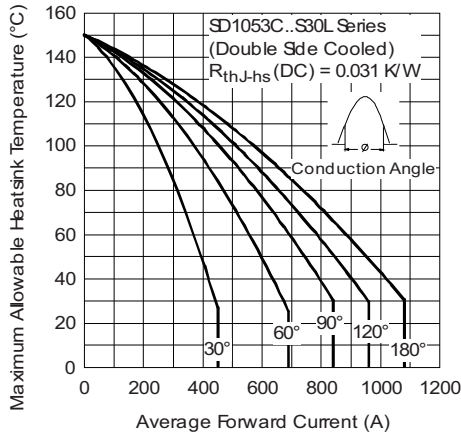

Fig. 7 - Current Ratings Characteristics

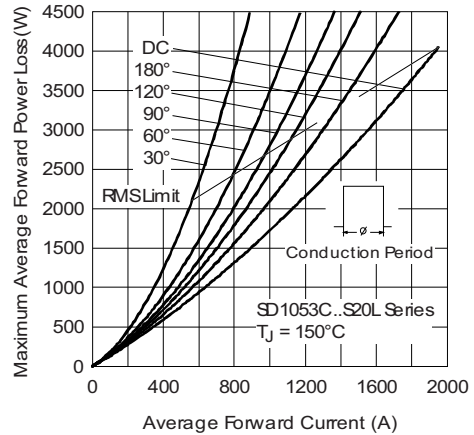

Fig. 10 - Forward Power Loss Characteristics

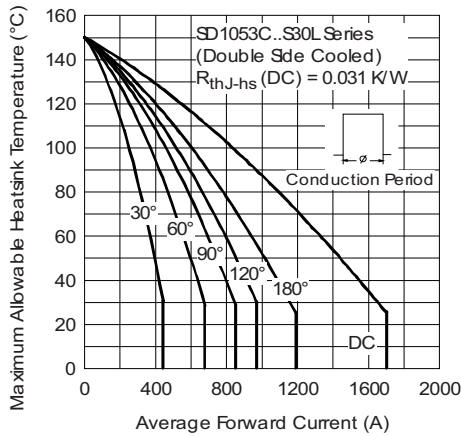

Fig. 8 - Current Ratings Characteristics

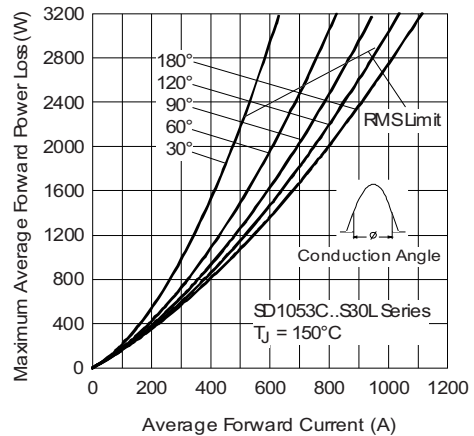

Fig. 11 - Forward Power Loss Characteristics

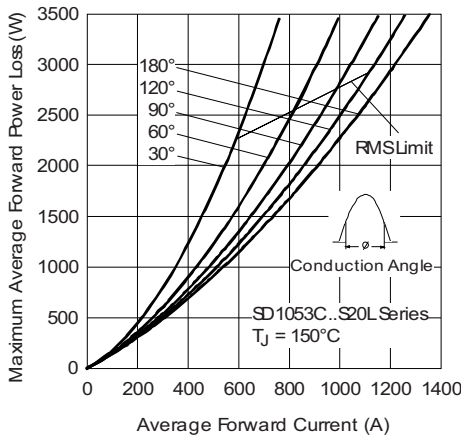

Fig. 9 - Forward Power Loss Characteristics

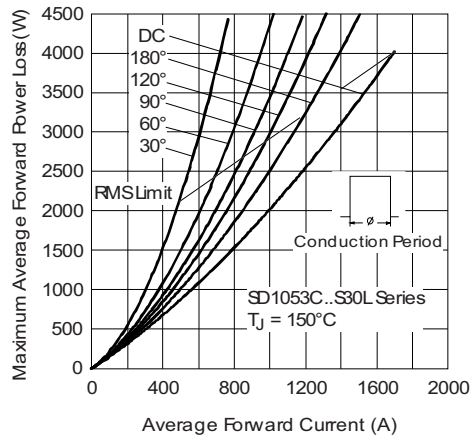

Fig. 12 - Forward Power Loss Characteristics

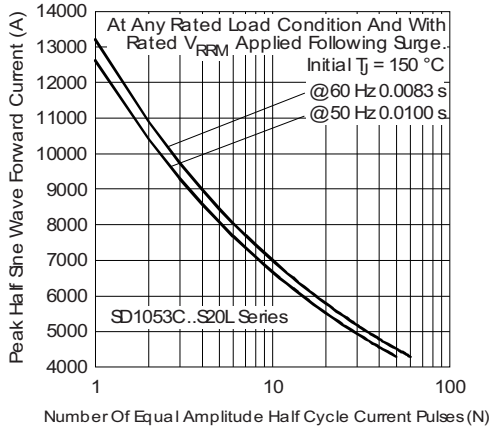

Fig. 13 - Maximum Non-Repetitive Surge Current

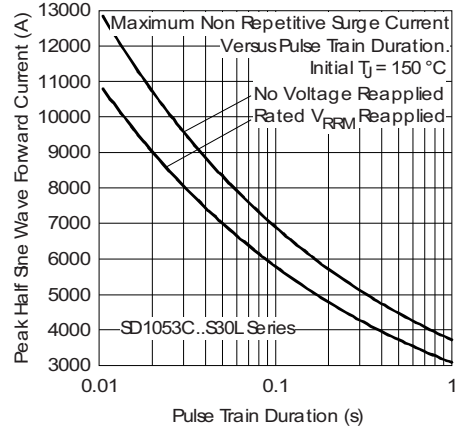

Fig. 16 - Maximum Non-Repetitive Surge Current Single and Double Side Cooled

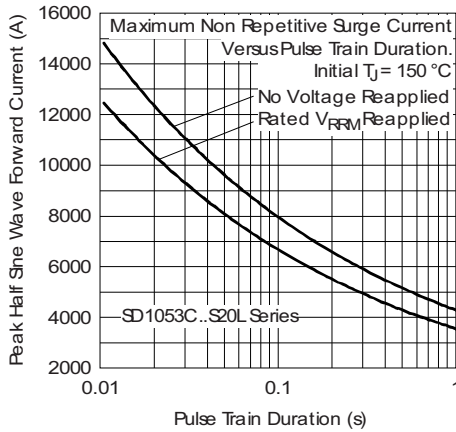

Fig. 14 - Maximum Non-Repetitive Surge Current

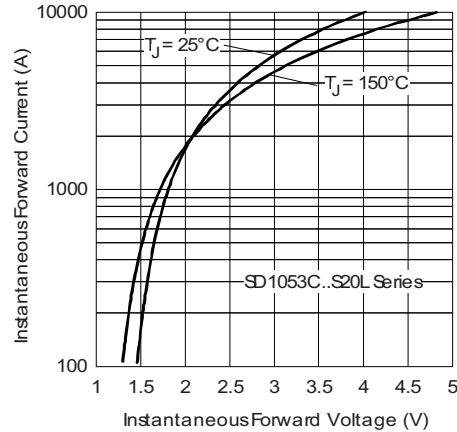

Fig. 17 - Forward Voltage Drop Characteristics

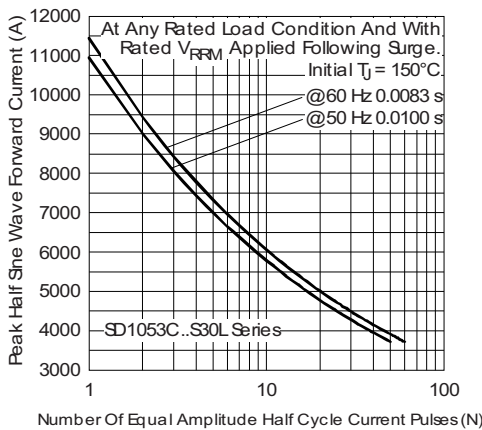

Fig. 15 - Maximum Non-Repetitive Surge Current Single and Double Side Cooled

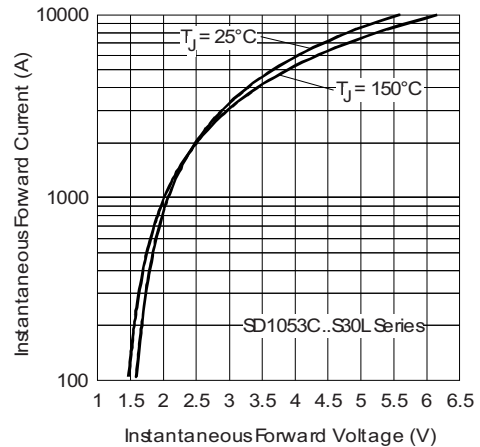

Fig. 18 - Forward Voltage Drop Characteristics

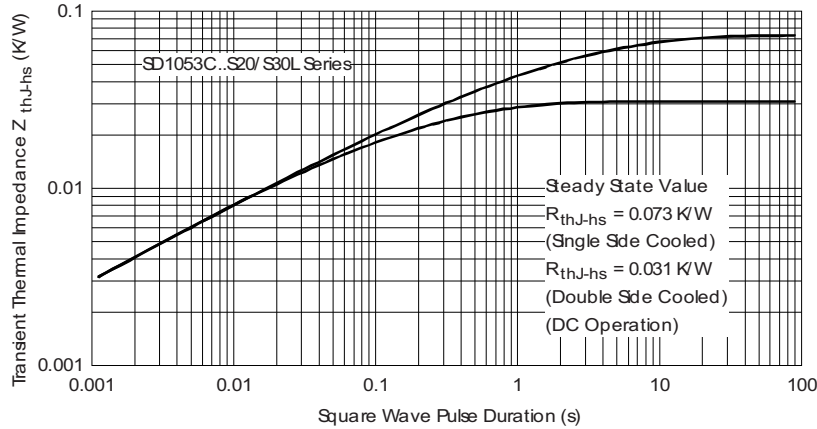

Fig. 19 - Thermal Impedance Z_{thJ-hs} Characteristic

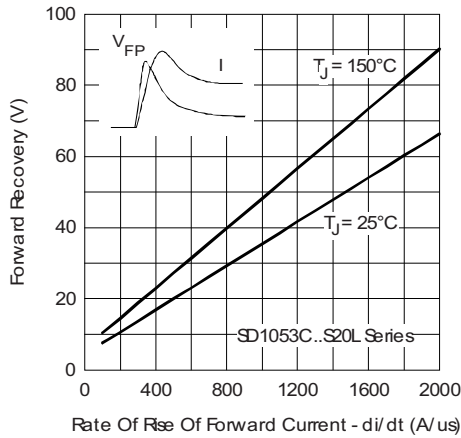

Fig. 20 - Typical Forward Recovery Characteristics

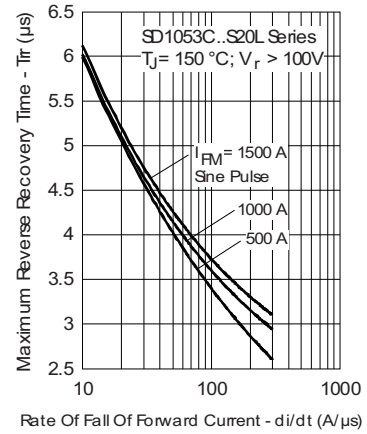

Fig. 22 - Recovery Time Characteristics

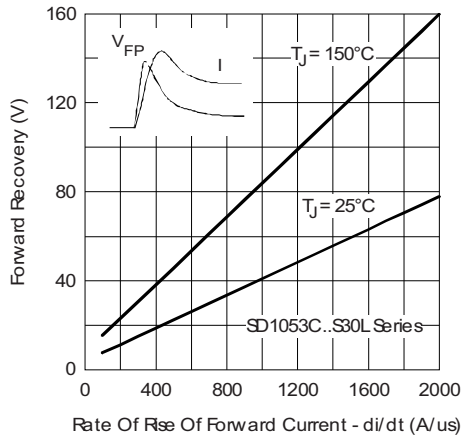

Fig. 21 - Typical Forward Recovery Characteristics

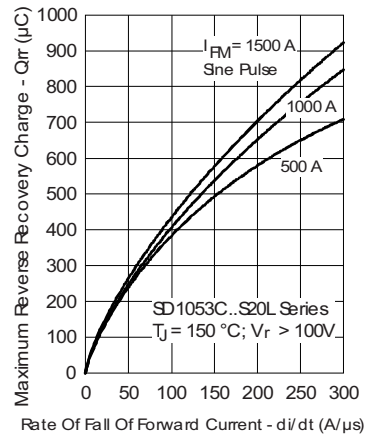

Fig. 23 - Recovery Charge Characteristics

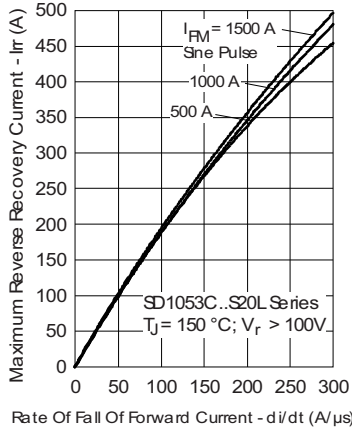

Fig. 24 - Recovery Current Characteristics

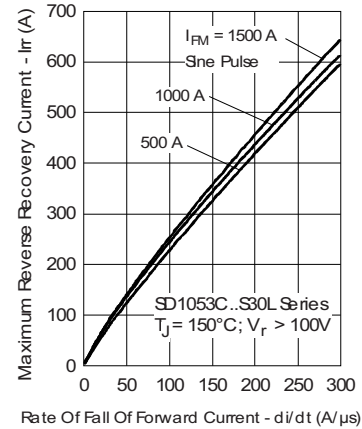

Fig. 27 - Recovery Current Characteristics

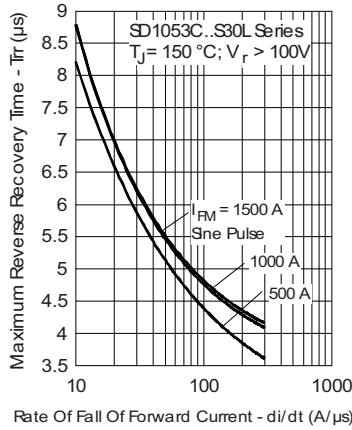

Fig. 25 - Recovery Time Characteristics

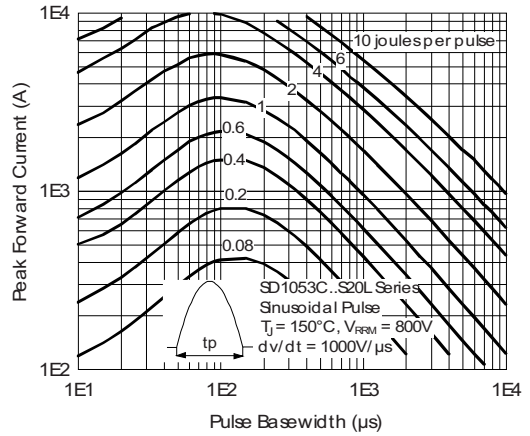

Fig. 28 - Maximum Total Energy Loss Per Pulse Characteristics

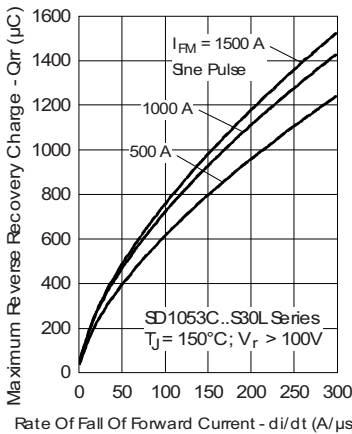

Fig. 26 - Recovery Charge Characteristics

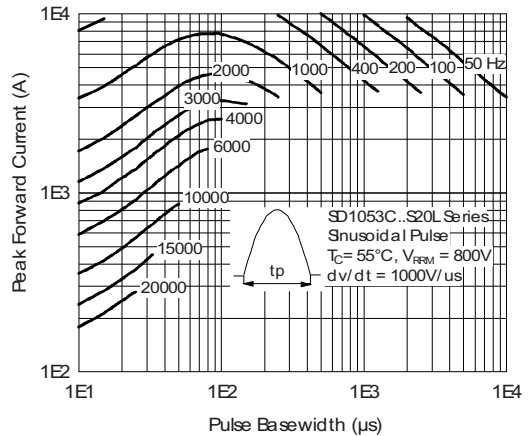

Fig. 29 - Frequency Characteristics

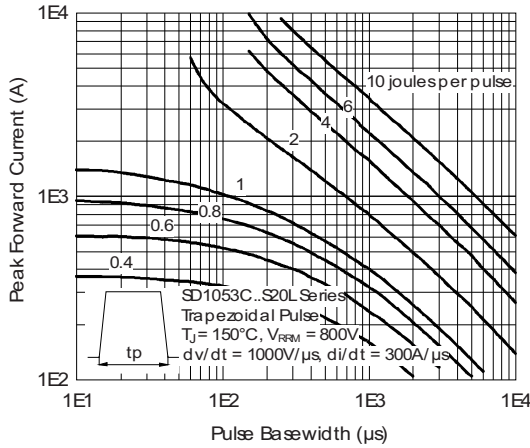

Fig. 30 - Maximum Total Energy Loss Per Pulse Characteristics

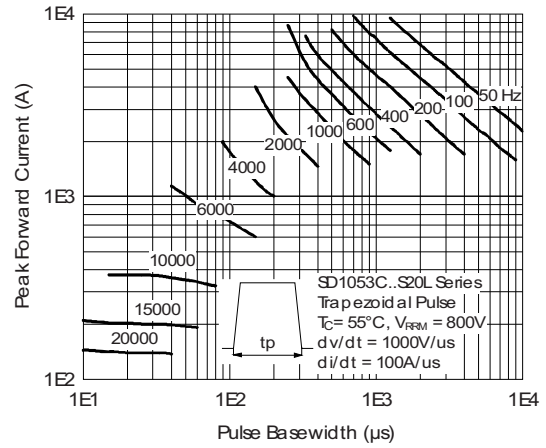

Fig. 33 - Frequency Characteristics

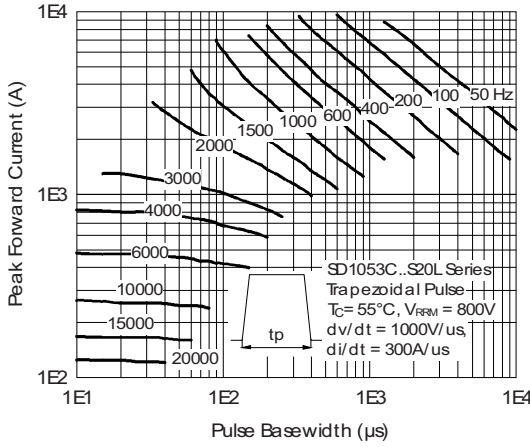

Fig. 31 - Frequency Characteristics

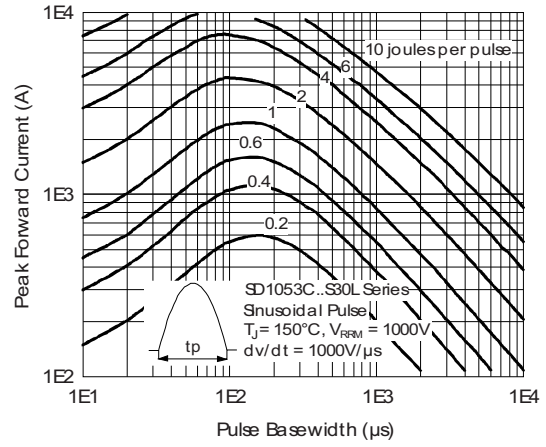

Fig. 34 - Maximum Total Energy Loss Per Pulse Characteristics

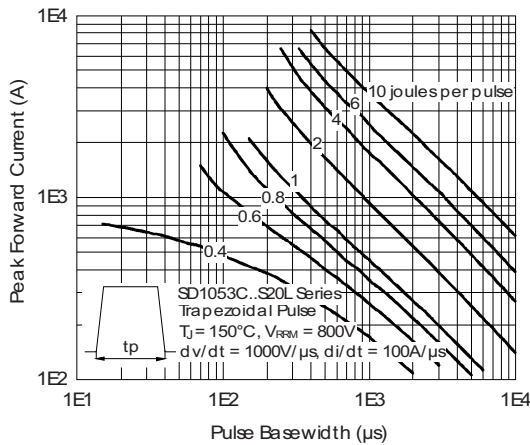

Fig. 32 - Maximum Total Energy Loss Per Pulse Characteristics

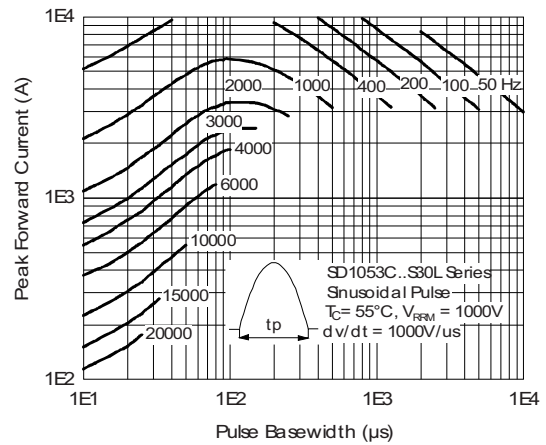

Fig. 35 - Frequency Characteristics

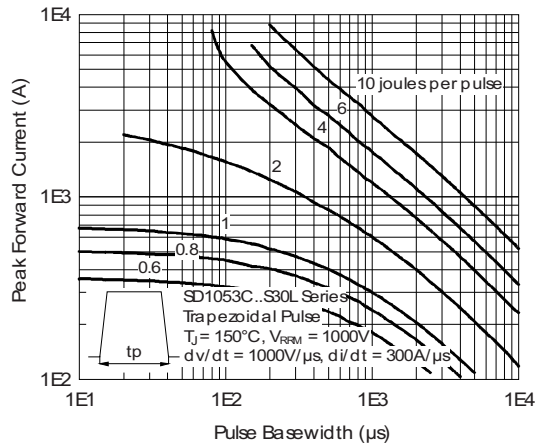

Fig. 36 - Maximum Total Energy Loss Per Pulse Characteristics

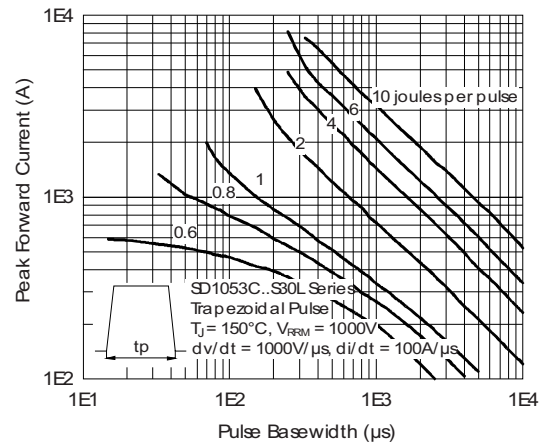

Fig. 38 - Maximum Total Energy Loss Per Pulse Characteristics

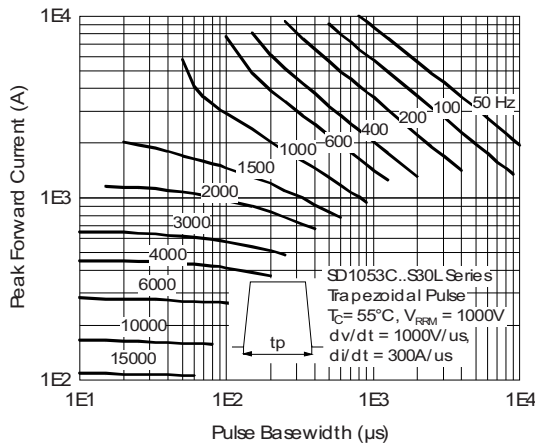

Fig. 37 - Frequency Characteristics

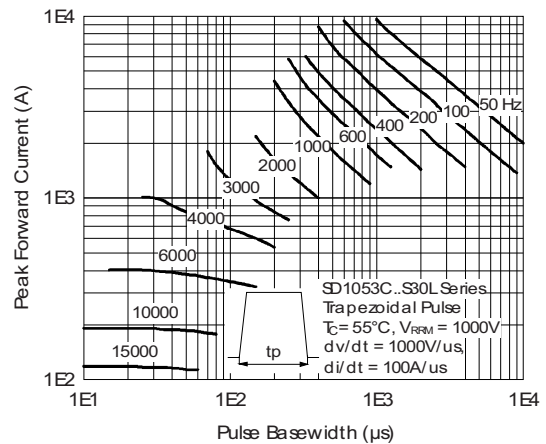

Fig. 39 - Frequency Characteristics

ORDERING INFORMATION TABLE

Device code	VS-	SD	105	3	C	30	S30	L
-------------	------------	-----------	------------	----------	----------	-----------	------------	----------

- ①
- ②
- ③
- ④
- ⑤
- ⑥
- ⑦
- ⑧

- 1** - Vishay Semiconductors product
- 2** - Diode
- 3** - Essential part number
- 4** - 3 = Fast recovery
- 5** - C = Ceramic PUK
- 6** - Voltage code x 100 = V_{RRM} (see Voltage Ratings table)
- 7** - t_{tr} code
- 8** - L = PUK case DO-200AB (B-PUK)

LINKS TO RELATED DOCUMENTS

Dimensions	www.vishay.com/doc?95246
------------	--

DO-200AB (B-PUK)

DIMENSIONS in millimeters (inches)

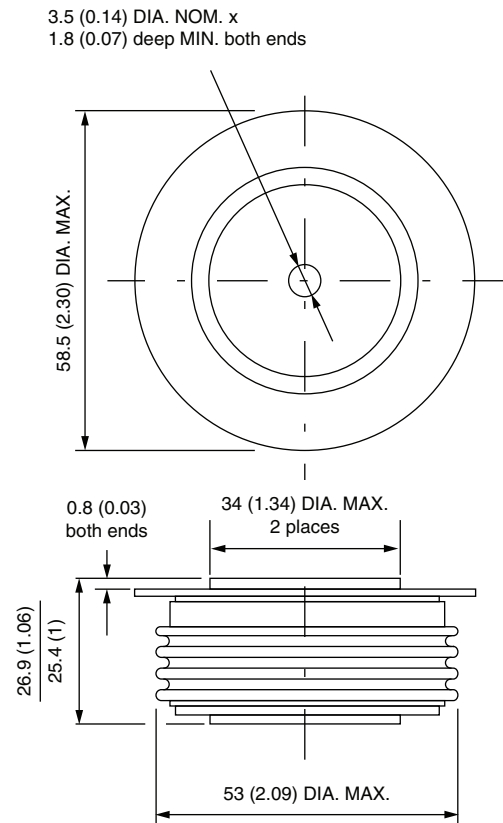

Quote between upper and lower pole pieces has to be considered after application of mounting force (see Thermal and Mechanical Specifications)



Disclaimer

ALL PRODUCT, PRODUCT SPECIFICATIONS AND DATA ARE SUBJECT TO CHANGE WITHOUT NOTICE TO IMPROVE RELIABILITY, FUNCTION OR DESIGN OR OTHERWISE.

Vishay Intertechnology, Inc., its affiliates, agents, and employees, and all persons acting on its or their behalf (collectively, "Vishay"), disclaim any and all liability for any errors, inaccuracies or incompleteness contained in any datasheet or in any other disclosure relating to any product.

Vishay makes no warranty, representation or guarantee regarding the suitability of the products for any particular purpose or the continuing production of any product. To the maximum extent permitted by applicable law, Vishay disclaims (i) any and all liability arising out of the application or use of any product, (ii) any and all liability, including without limitation special, consequential or incidental damages, and (iii) any and all implied warranties, including warranties of fitness for particular purpose, non-infringement and merchantability.

Statements regarding the suitability of products for certain types of applications are based on Vishay's knowledge of typical requirements that are often placed on Vishay products in generic applications. Such statements are not binding statements about the suitability of products for a particular application. It is the customer's responsibility to validate that a particular product with the properties described in the product specification is suitable for use in a particular application. Parameters provided in datasheets and / or specifications may vary in different applications and performance may vary over time. All operating parameters, including typical parameters, must be validated for each customer application by the customer's technical experts. Product specifications do not expand or otherwise modify Vishay's terms and conditions of purchase, including but not limited to the warranty expressed therein.

Except as expressly indicated in writing, Vishay products are not designed for use in medical, life-saving, or life-sustaining applications or for any other application in which the failure of the Vishay product could result in personal injury or death. Customers using or selling Vishay products not expressly indicated for use in such applications do so at their own risk. Please contact authorized Vishay personnel to obtain written terms and conditions regarding products designed for such applications.

No license, express or implied, by estoppel or otherwise, to any intellectual property rights is granted by this document or by any conduct of Vishay. Product names and markings noted herein may be trademarks of their respective owners.