

SPECIFICATION

- Part No. : **CGIP.25.4.A.02**
- Product Name : 25mm Iridium® / GPS Ceramic Patch Antenna
1575–1626MHz Single Feed
- Feature : Wide Operation Band
High Gain
Dims:25*25*4mm
Single feed ceramic patch for combined
Iridium®/GPS applications
Iridium® has certified the CGIP.25.4.A.02
antenna for commercial use in
connection with the Iridium®
Communications System
RoHS Compliant



1. Introduction

The Taoglas GPS/Iridium® CGIP.25 ceramic patch antenna is a low profile (4mm), small footprint (25*25mm), single feed antenna designed for combined Iridium®/GPS applications. It has been specifically designed to provide excellent performance in the 1575.42 to 1626.5MHz range.

This ceramic patch offers a typical peak gain of 5dBi for GPS and Iridium®.

These patches are mounted via pin and double-sided adhesive.

While the antenna is certified, some antenna detuning or device or layout issues* may prevent a device from passing Iridium® certification. Taoglas offers performance testing and verification, as well as a custom tuning service for the patch for a specific customer device and ground-plane mounting. Taoglas can also pre-test the whole device for Iridium® certification. Please Contact Us for any assistance required.

*Actual GPS/Iridium® system performance on a device is a function of the overall system design of the device and environment where the device is used. Use of even a tuned patch or any antenna on a compromised device design or application will not guarantee good GPS/Iridium® performance.

2. Specification

GPS/Iridium® Antenna		
Operating Bands	GPS	Iridium®
Frequency (MHz)	1575.42	1621
VSWR	< 2:1	<1.5:1
Efficiency (%)	75 typ.	75 typ.
Gain @ Zenith (dBi)	5 typ.	5 typ.
Average Gain (dBi)	>-2	>-2
Impedance	50Ω	
MECHANICAL		
Patch Dimensions (mm)	25x 25 x 4	
Pin Dimension (mm)	φ0.9 x 1.65	
Weight (g)	5	
ENVIRONMENTAL		
Operation Temperature	-40°C to 85°C	
Storage Temperature	-40°C to 105°C	
Humidity	Non-condensing 40°C 95% RH	
Soldering Temperature	290°C for 3 seconds max.	

* All electrical properties are tested with the patch on 70*70mm ground.

3. Antenna Properties

3.1 Return Loss

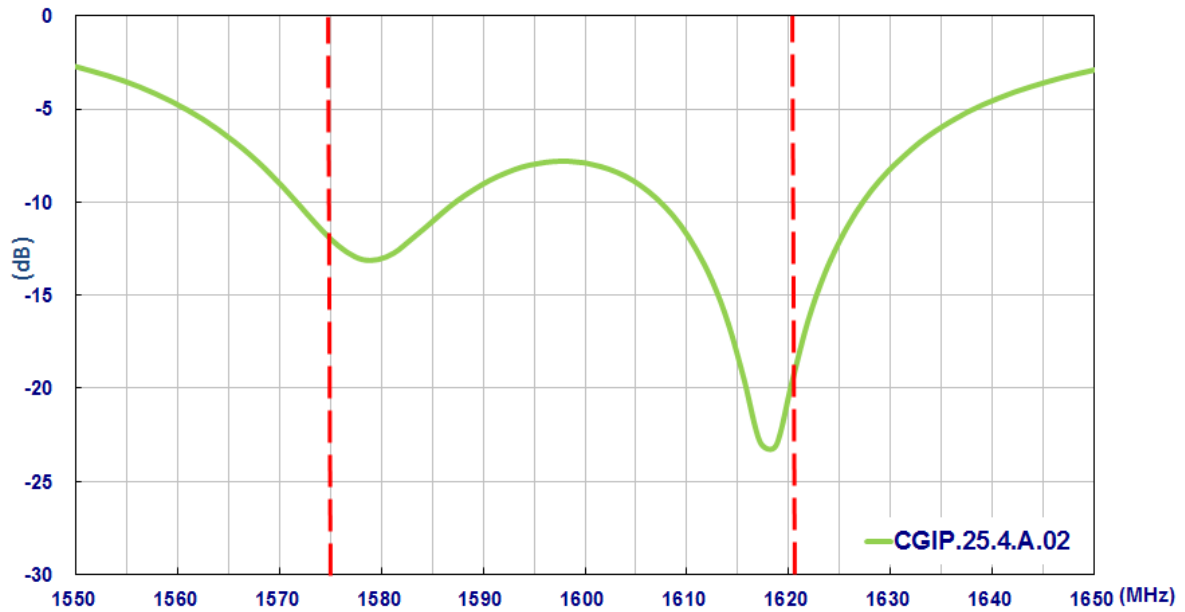

3.2 VSWR

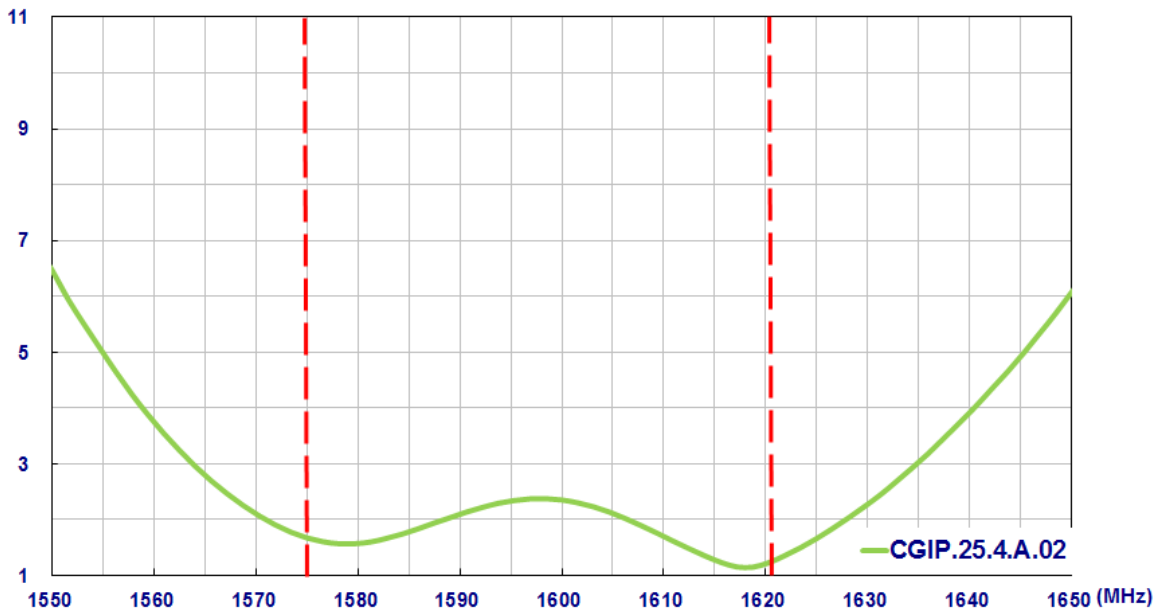

3.3 Radiation Efficiency

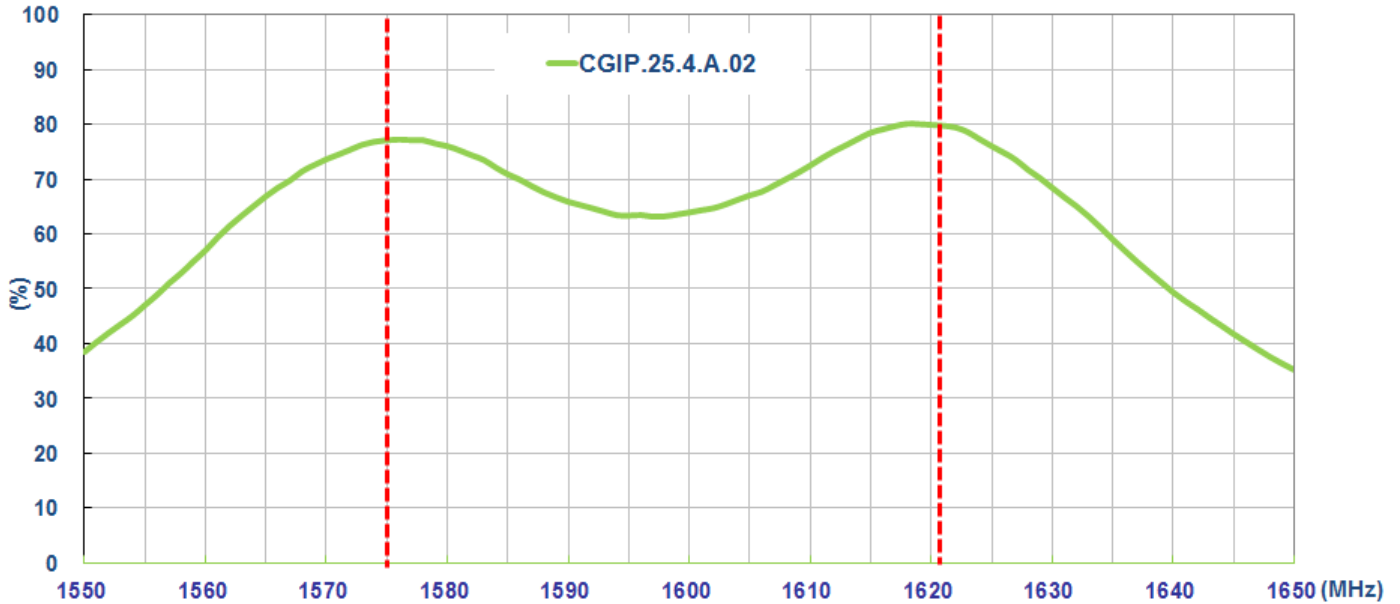

3.4 Peak Gain

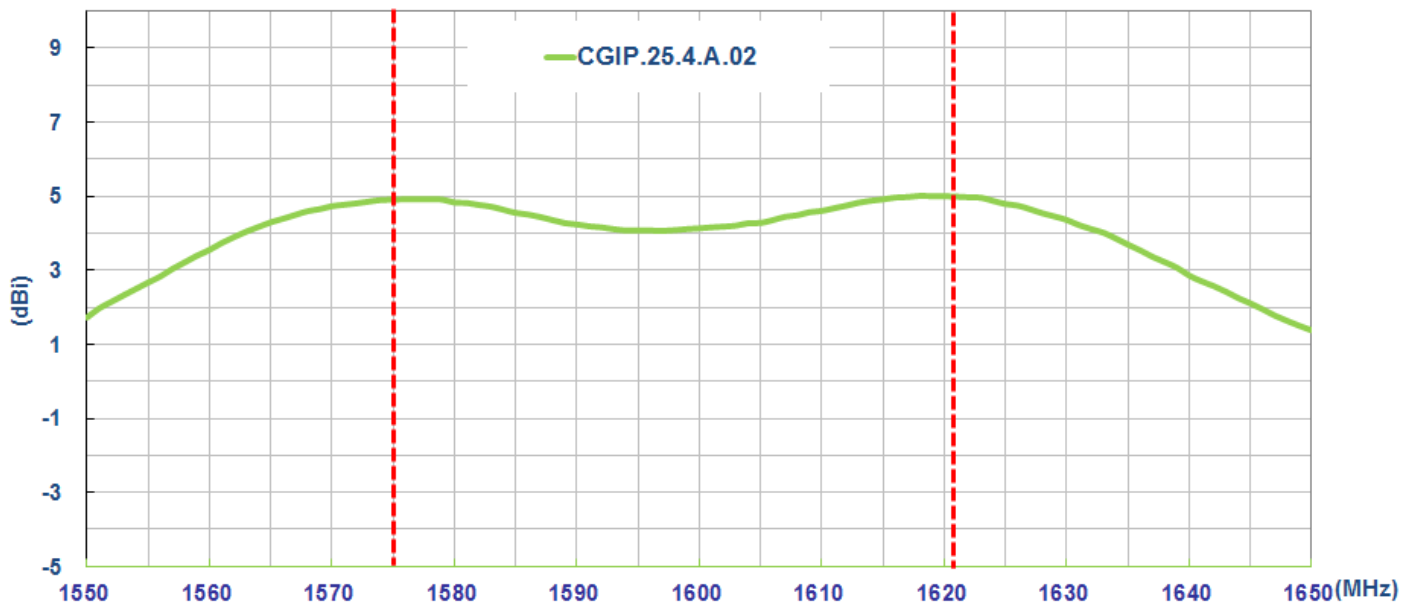

3.5 Average Gain

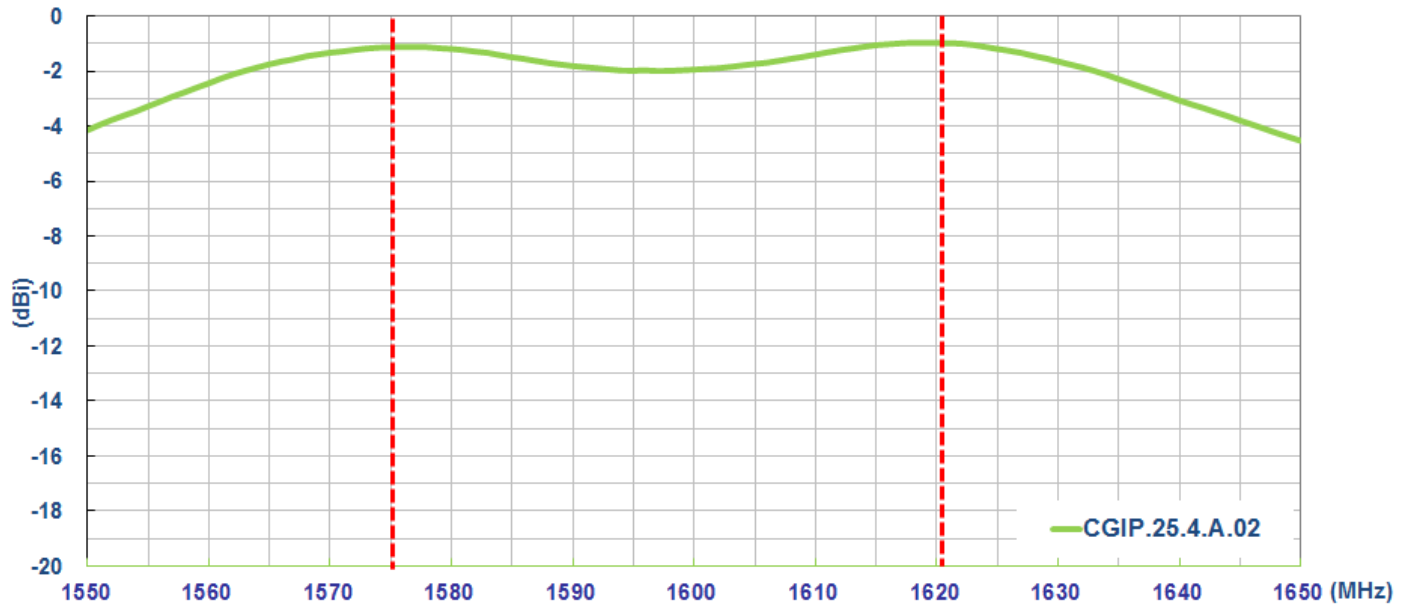

4. Antenna Radiation



The antenna is measured on a CTIA certified anechoic chamber. The CGIP.25 antenna is put on a 70*70mm ground plane.



4.1 3D Radiation Pattern @ 1575.42MHz

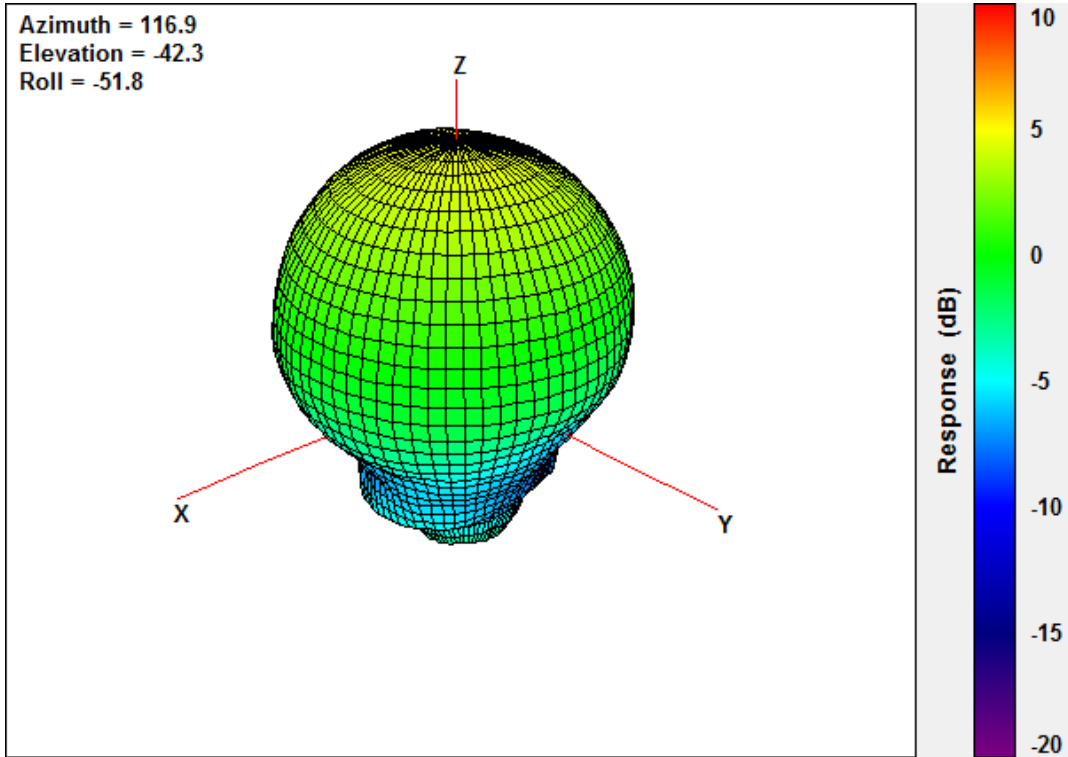



4.2 3D Radiation Pattern @ 1621MHz

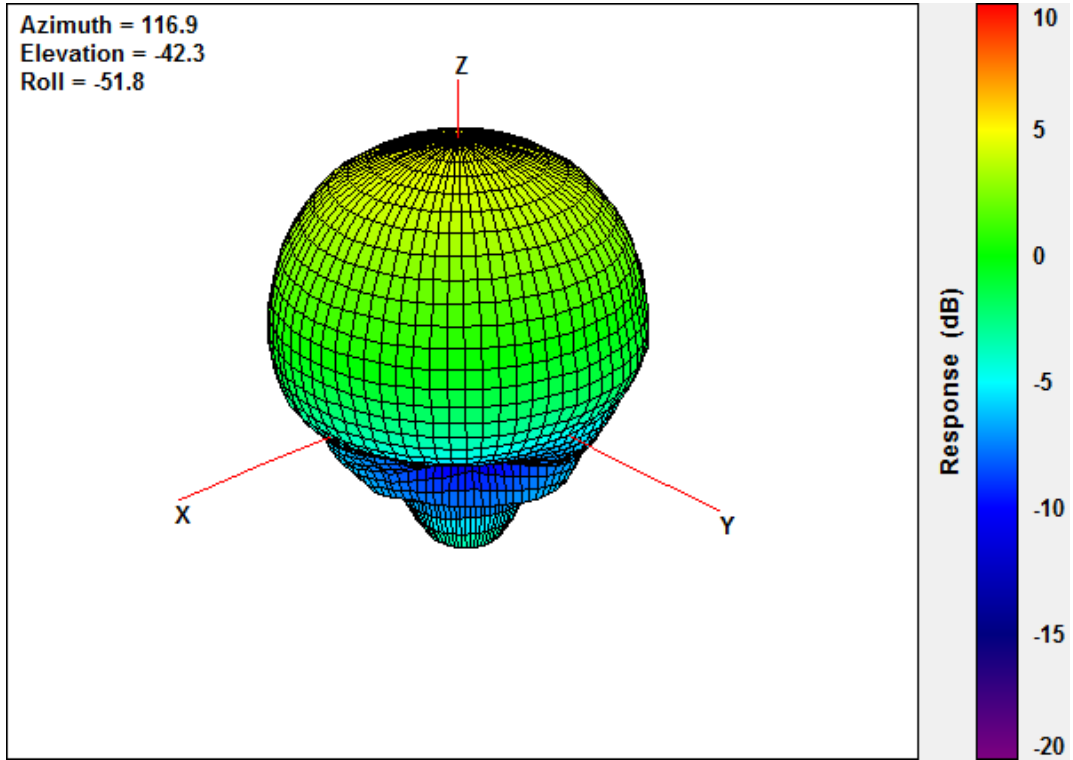

4.3 2D Radiation Pattern

XZ Plane

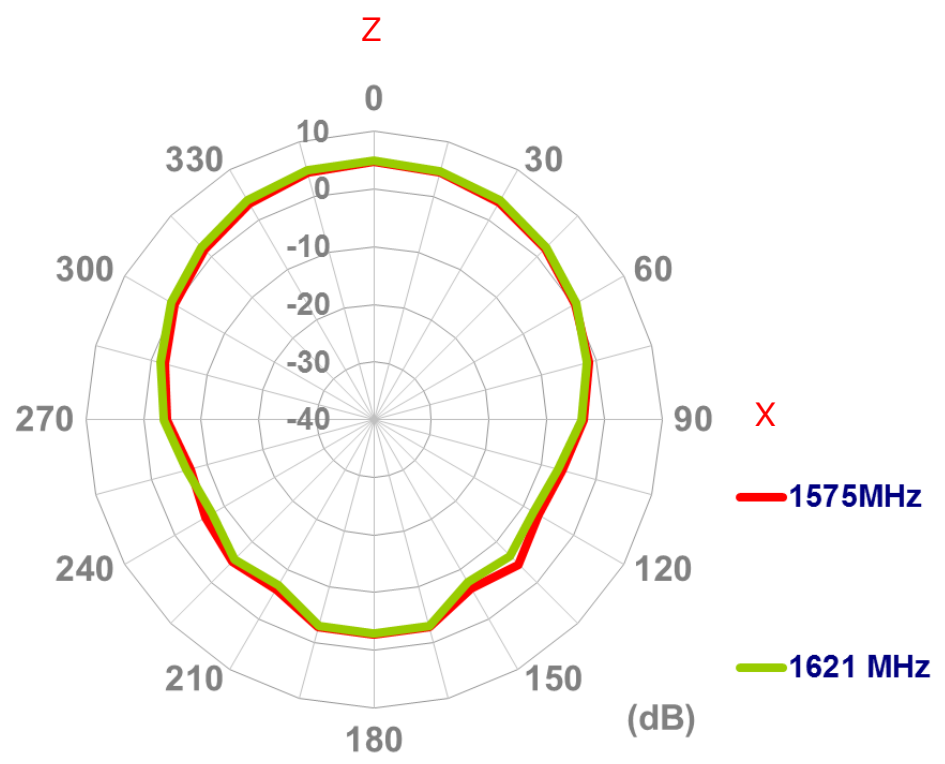

ZY Plane

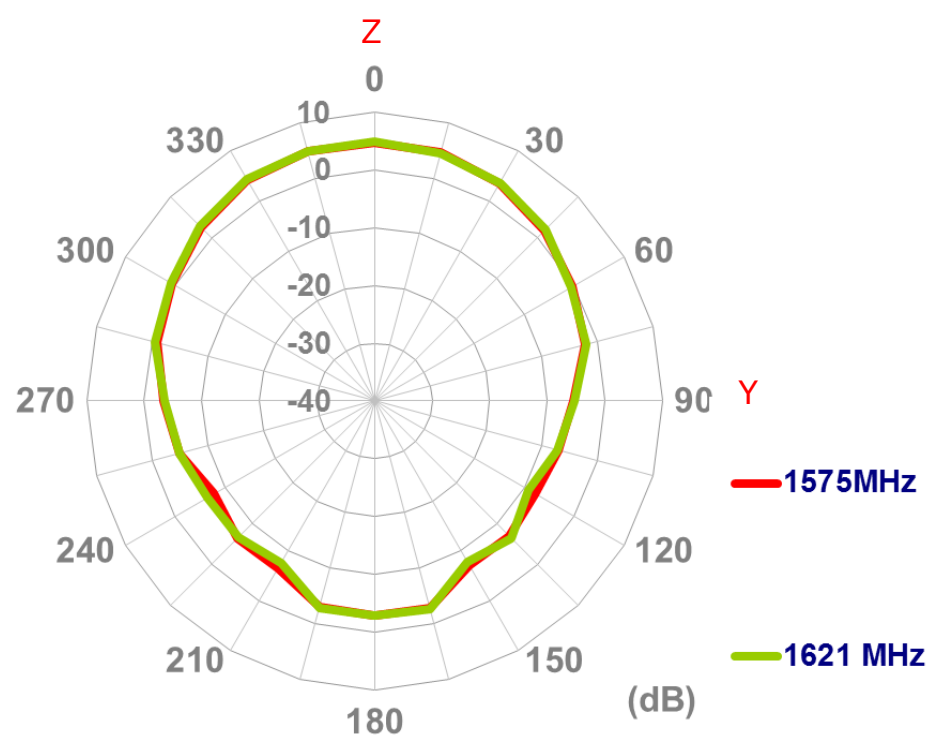

XY Plane

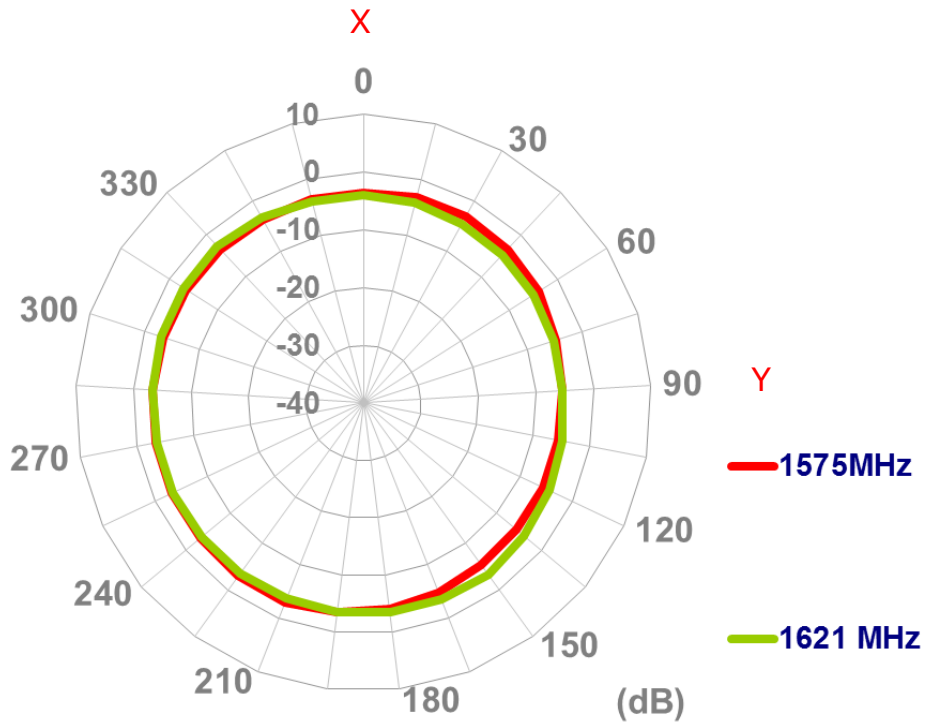

5. Mechanical Drawing (Unit: mm)

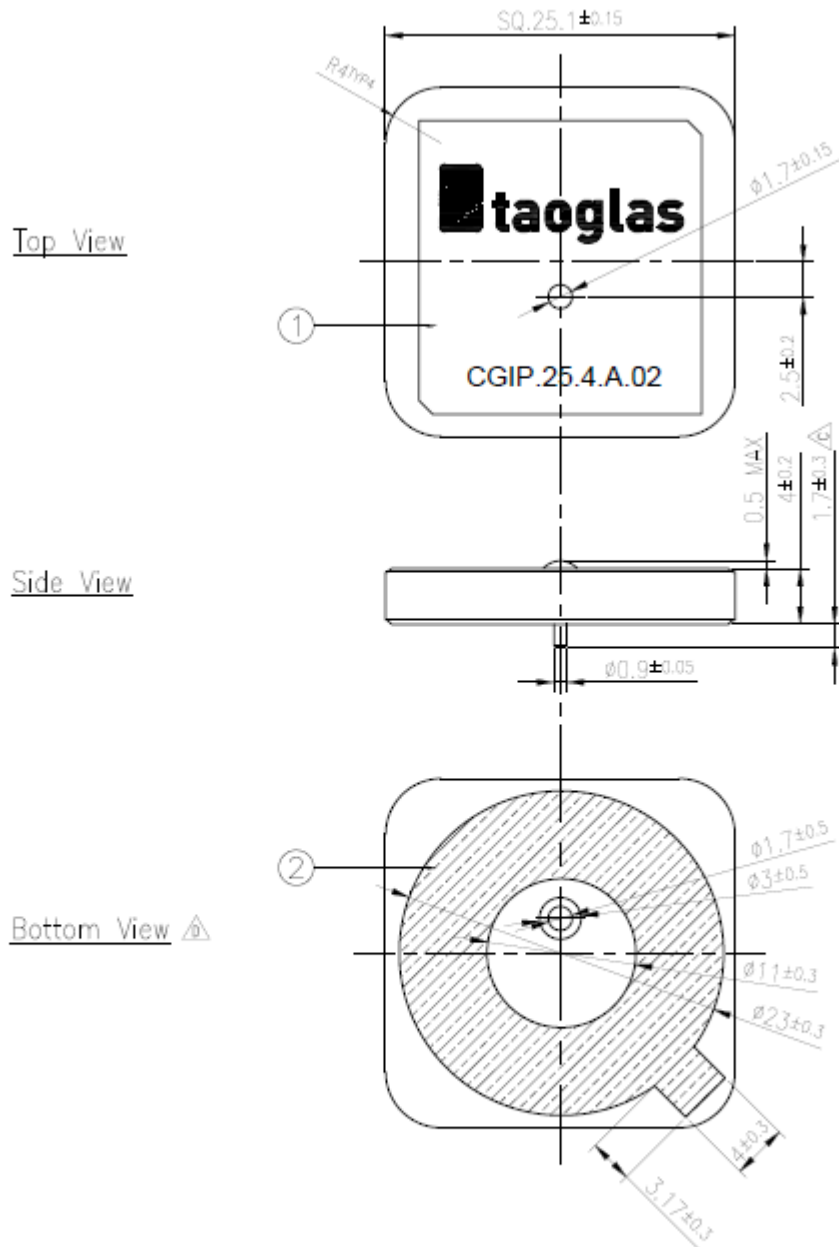

Note:

1. Double sided adhesive area 

	Name	P/N	Material	Finish	QTY
1	Patch 25.1*25.1*4mm	001515E000007A	Ceramic	Clear	1
2	Double sided adhesive	001515E000007A	NITTO05015	White Liner	1

6. CGIP.25.4.A.02 on Evaluation Board

The CGIP.25.4.A.02 is designed with 70*70mm square metal plane, put the antenna at the center of the metal ground, and then the antenna will have excellent performance. The recommendation setup is shown as follows.

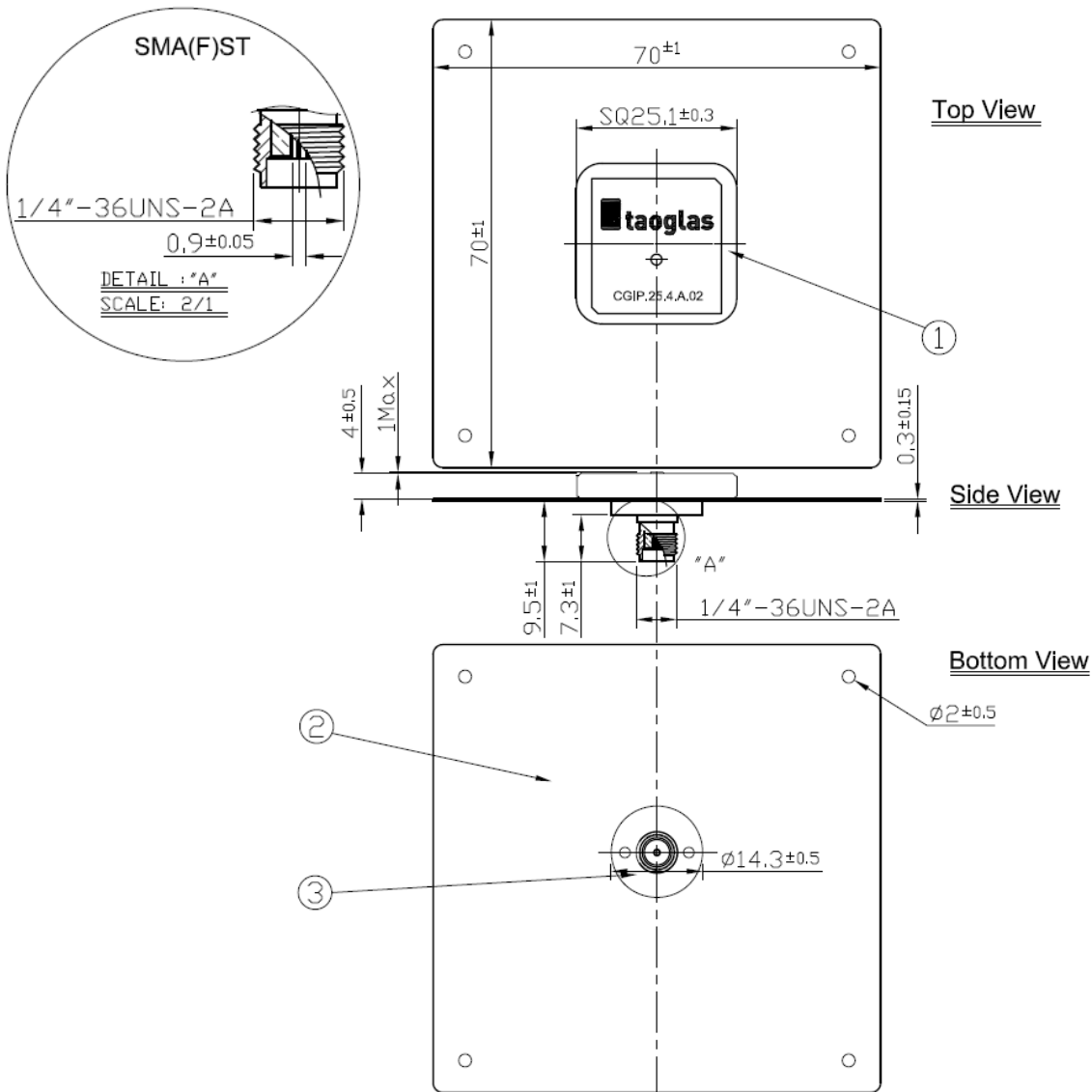

	Name	Material	Finish	QTY
1	Patch 25x25x4	Ceramic	Clear	1
2	Ground	Brass	Clear	1
3	SMA(F)ST	Brass	Gold	1

7. PCB Layout Recommendation

Top Side

Bottom Side

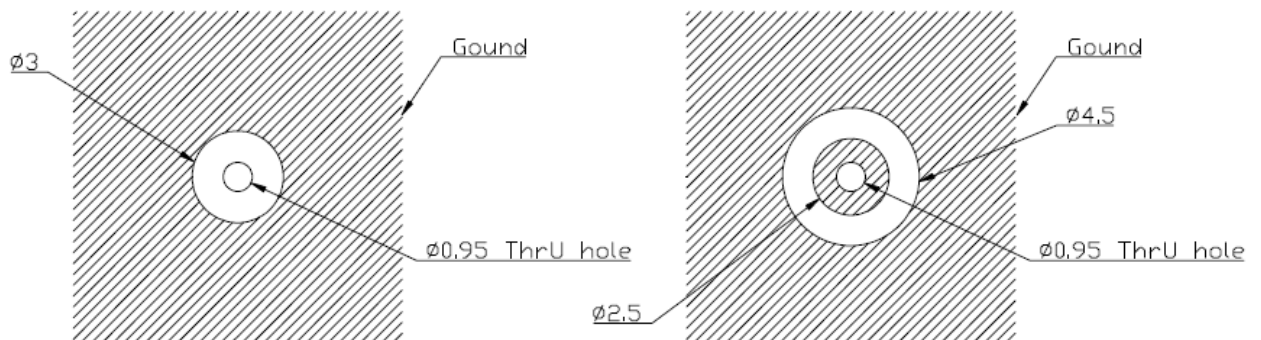

*The antenna feeding in transmission line should connect with the ϕ 2.5 circle at the Bottom Side, and keep transmission line impedance at 50 ohms for good power transmit from system to antenna.



8. Packaging

50 pieces
per tray

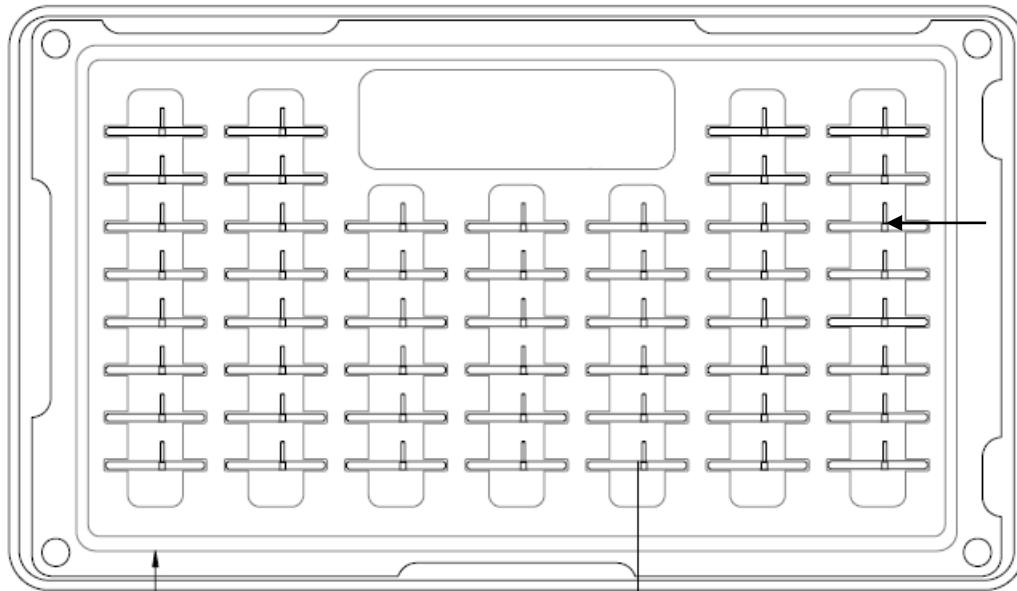

4 trays
per box

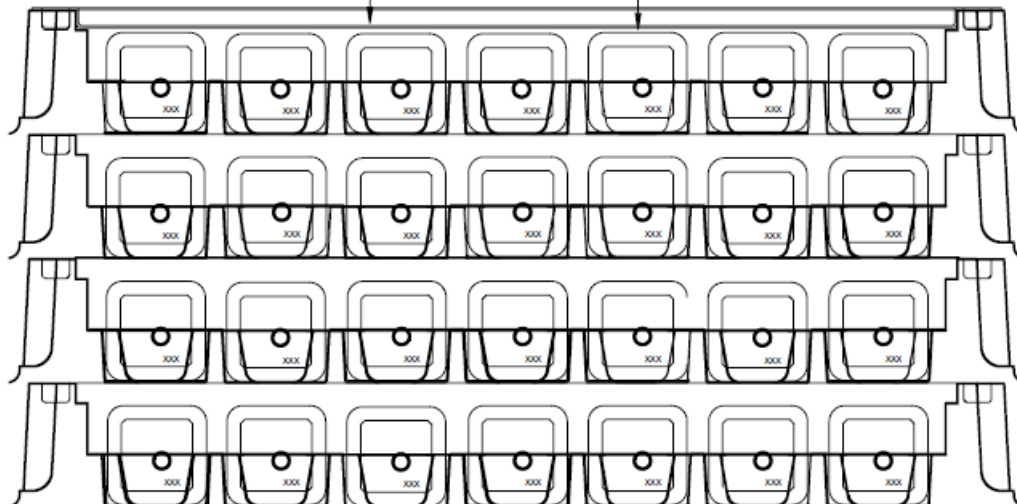

50 pieces per tray

4 trays per box = 200 pieces per box



4 boxes per carton = 800 piece per carton

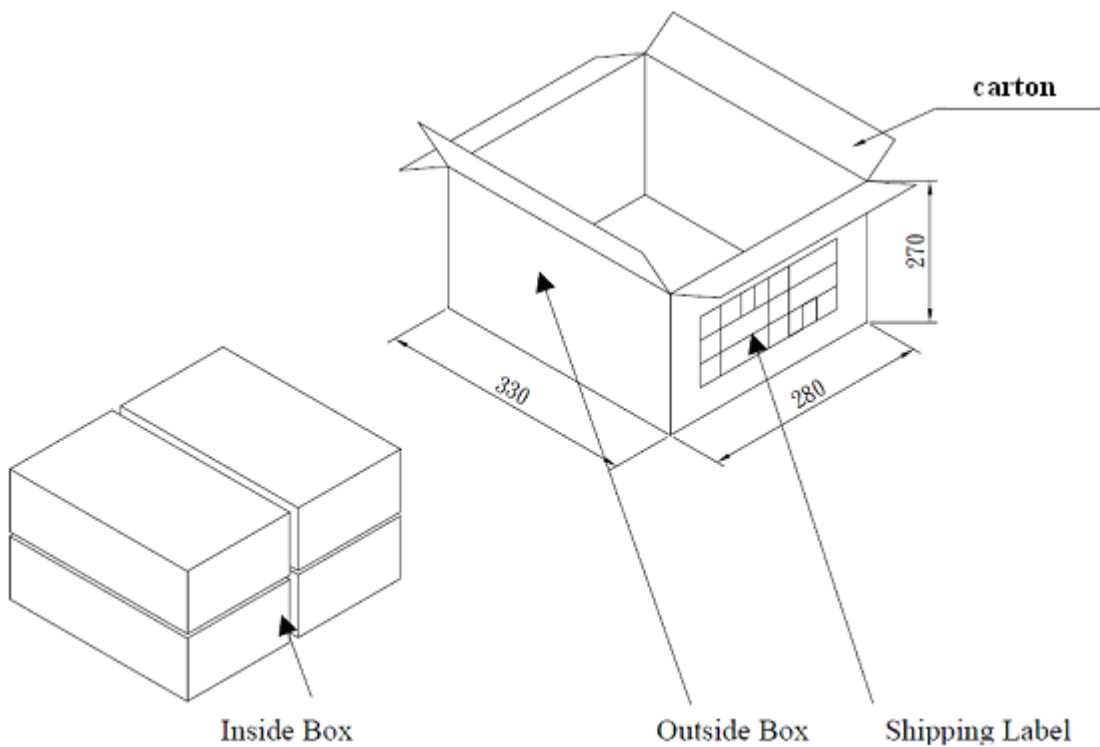
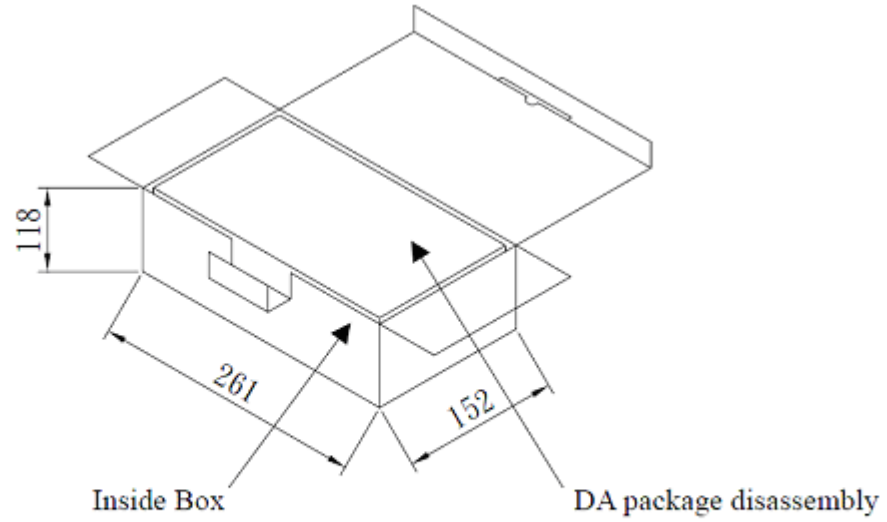

Unit: mm



Taoglas makes no warranties based on the accuracy or completeness of the contents of this document and reserves the right to make changes to specifications and product descriptions at any time without notice. Taoglas reserves all rights to this document and the information contained herein.

Reproduction, use or disclosure to third parties without express permission is strictly prohibited.

Copyright © Taoglas Ltd.