

SPECIFICATION

Part No.	:	TG.19.0112
Product Name	:	Mini Helical Quad-Band Cellular Antenna Connector Mount Monopole GSM-DCS-PCS -CDMA-GPRS-EDGE 824 MHz ~ 1990 MHz (850/900/1800/1900)
Features	:	0dBi Gain SMA(M) Fixed Right Angle plug, 50 ohms 28.5*17.0*7.8 mm RoHS Compliant



1. INTRODUCTION

The TG.19 Quad-band GSM-DCS-PCS-CDMA-GPRS-EDGE 824MHz to 1990MHz monopole helical antenna is a quality robust antenna with high gain in a small form factor. Its tiny size allows it to be used inside as well as outside product housings.

Connection is made via fixed right angle SMA(M) connector with a hardened waterproof PU casing. Care should be taken that the antenna is connected to the device main-board ground, through the mating connector grounding on the device main-board.

For smaller ground-plane devices or for devices where a ground-connection to antenna is not possible we recommend the TG.10 or TG.30 dipole antennas which do not need to couple to ground.

2. SPECIFICATION

ELECTRICAL				
Antenna	TG19			
Standard	GSM/DCS/PCS/CDMA/GPRS/EDGE			
Operation Frequency (MHz)	824~880	880~960	1710~1880	1880~1990
Polarization	Linear	Linear	Linear	Linear
Impedance	50 Ohms	50 Ohms	50 Ohms	50 Ohms
VSWR	2.0:1	2.3.0:1	2.3:1	<2.0:1
Return Loss (dB)	-10.0	-8.0	-8	-10
Efficiency (%)	45	45	45	55
Gain (dBi)	0.0	0.0	0.5	1.2
Average Gain (dB)	-3.5	-3.5	-3.5	-2.7
Max Input Power	5 W	5 W	5 W	5 W

* The TG.19 antenna performance was measured on a 110*45 mm evaluation board

MECHANICAL	
Dimensions (mm)	28.5x17.0x.7.8
Required Space (mm)	28.5x17x.7.8
Material	UV Resistant ABS
Connector	SMA(M)RA

ENVIRONMENTAL	
Operation Temperature	-40°C to 85°C
Storage Temperature	-40°C to 85°C
Relative Humidity	40% to 95%
RoHs Compliant	Yes

3. TEST SET UP

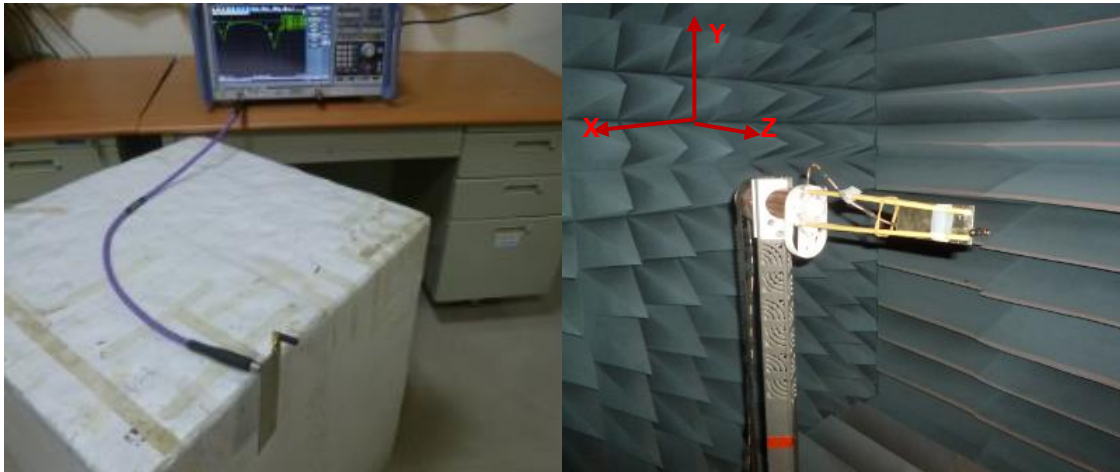

Figure 1. Impedance measurements (left hand) and peak gain, efficiency and radiation pattern measurements (right hand).

4. ANTENNA PARAMETERS

4.1. Return Loss

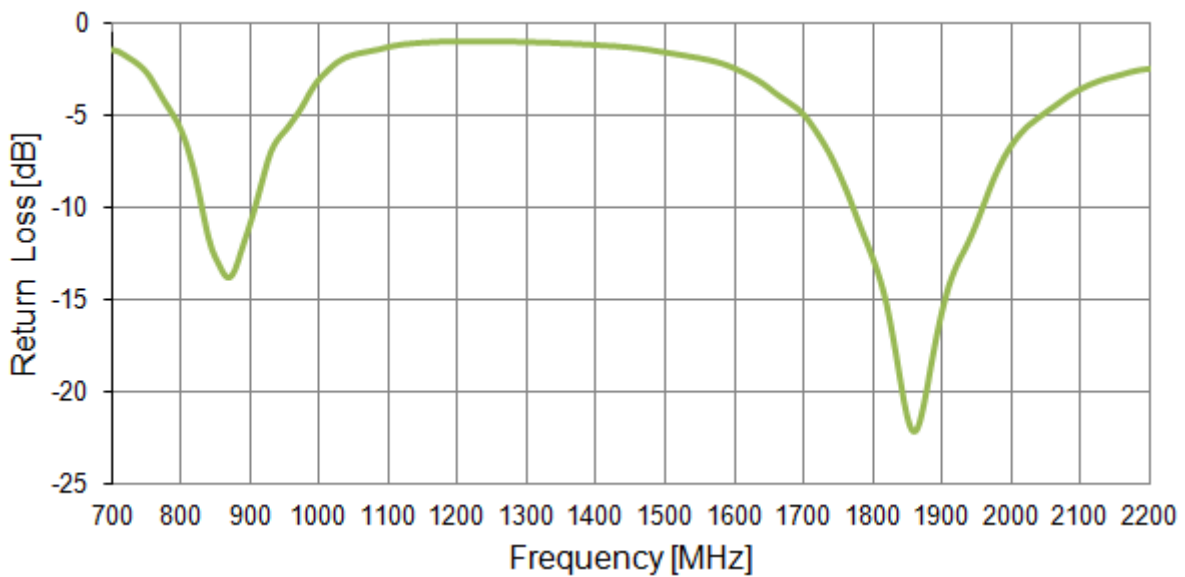

Figure 2. Return loss of the TG19 Antenna.

4.2. VSWR

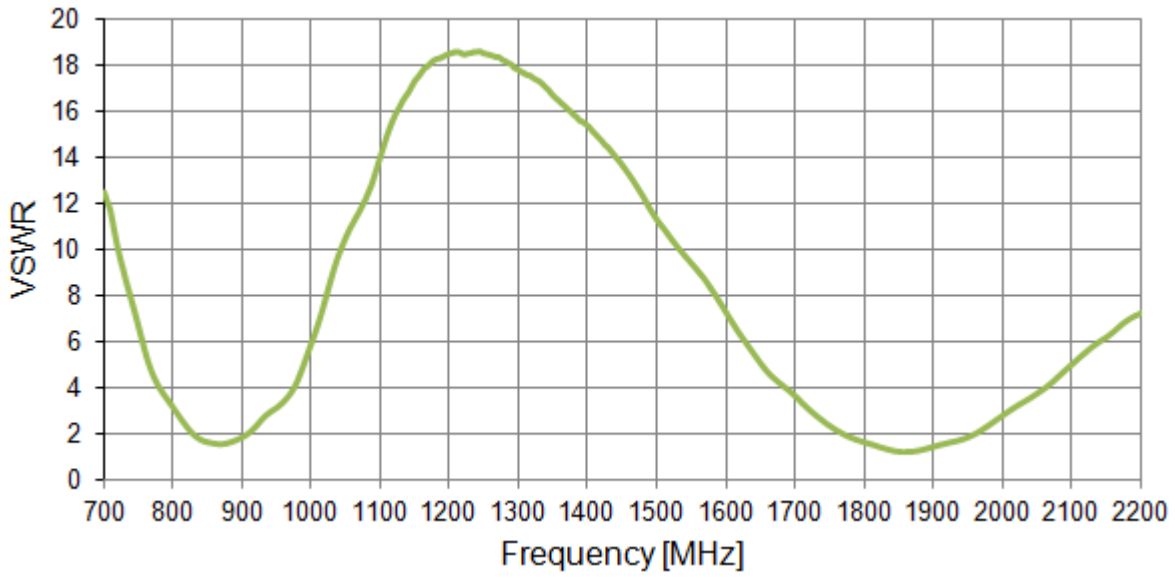

Figure 3. VSWR of the TG19 Antenna.

4.3. Efficiency

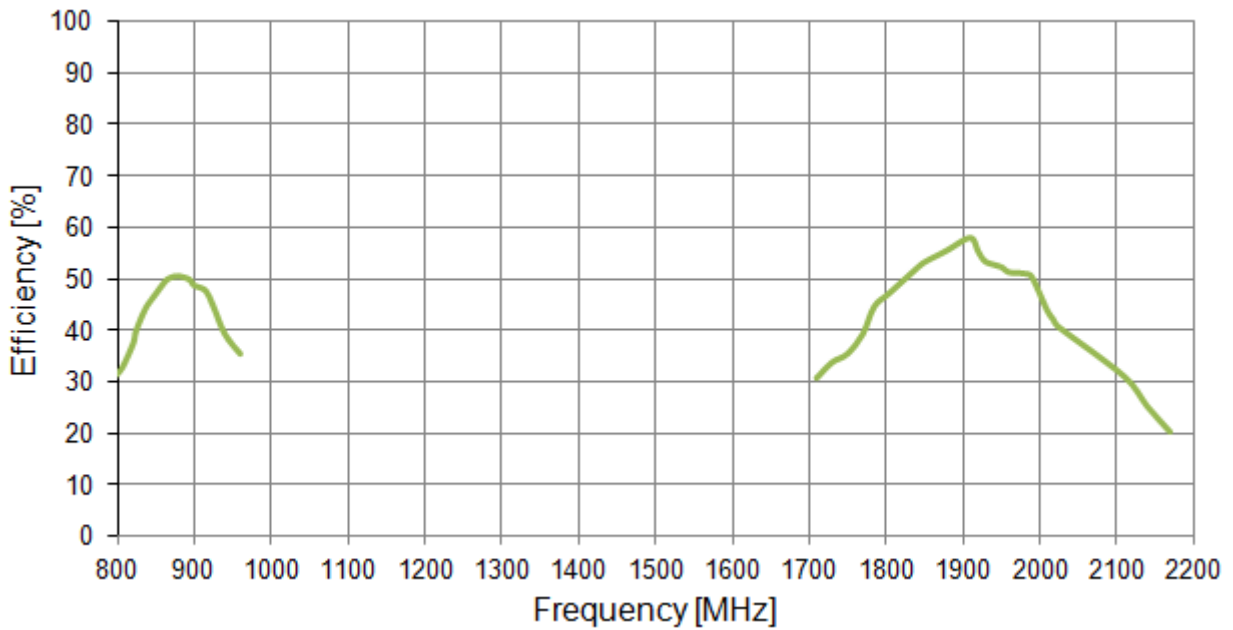

Figure 4. Efficiency of the TG19 antenna.

4.4. Peak Gain

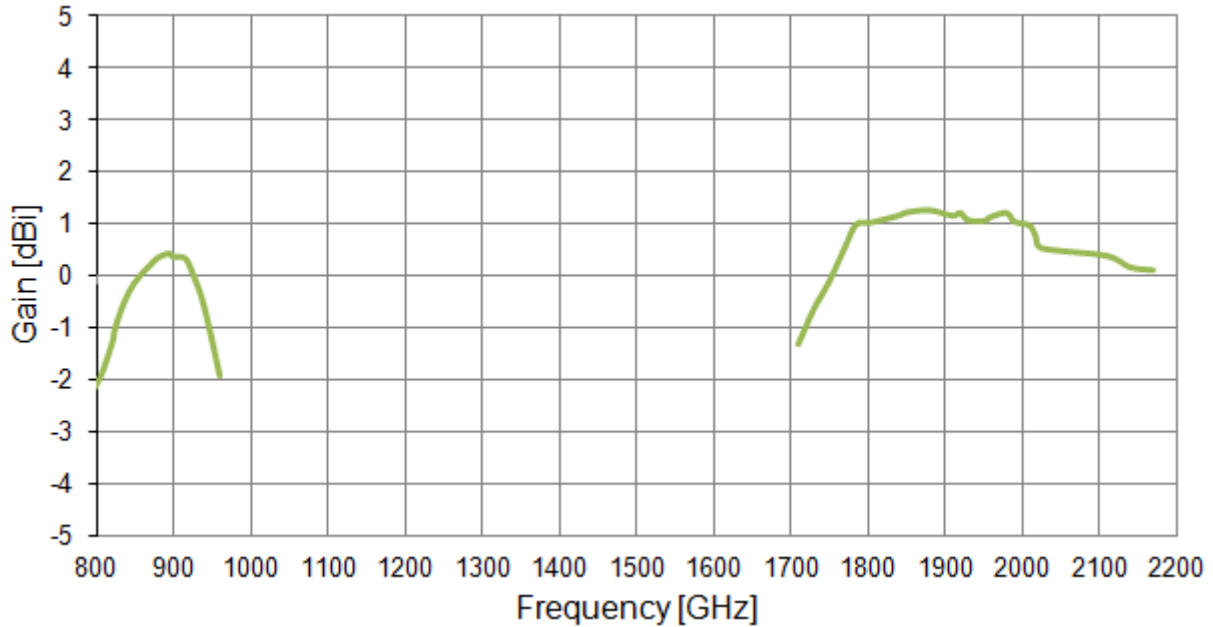

Figure 5. Peak Gain of the TG19 Antenna.

4.5. Average Gain

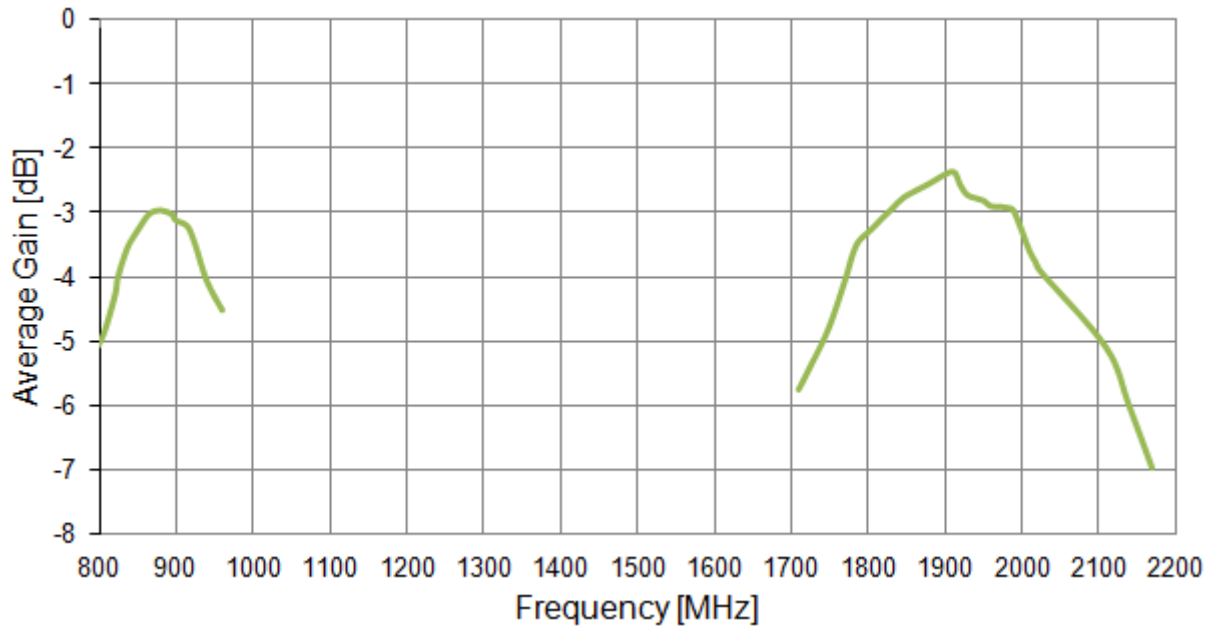

Figure 6. Average Gain of the TG19 Antenna.

5. Antenna Radiation Patterns

5.1. 3D Radiation pattern

Azimuth = -7.0
Elevation = -15.0
Roll = -115.0

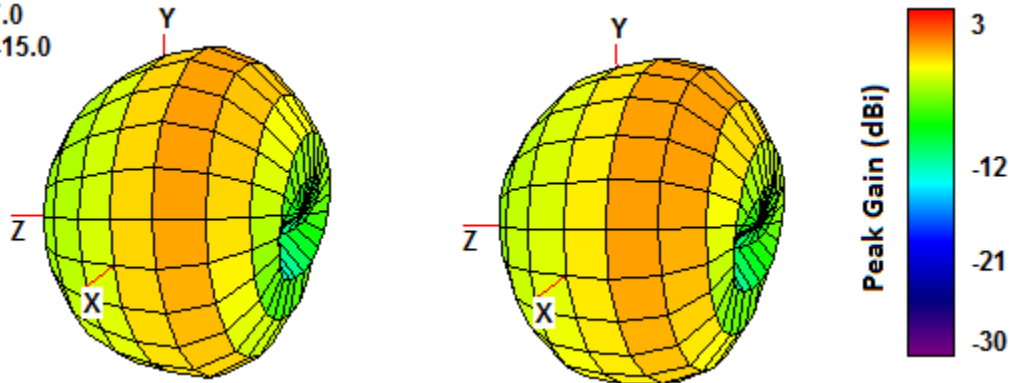

Figure 7. 3D Radiation Pattern at 850 MHz (left) 915 MHz (right) of the TG19 Antenna.

Azimuth = -7.0
Elevation = -15.0
Roll = -115.0

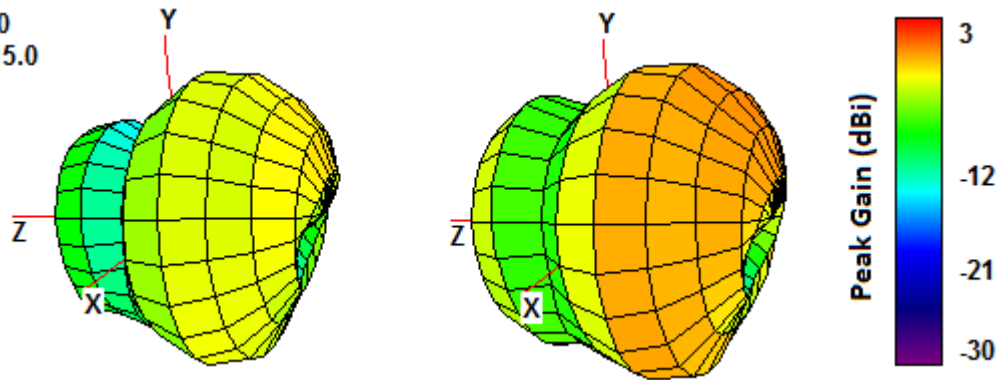

Figure 8. 3D Radiation Pattern at 1710 MHz (left), 1805 MHz (right) of the TG19 Antenna.

Azimuth = -7.0
 Elevation = -15.0
 Roll = -115.0

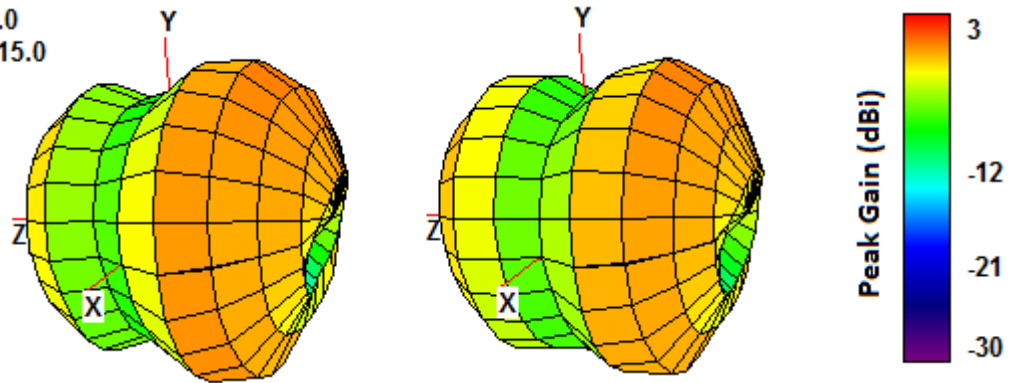
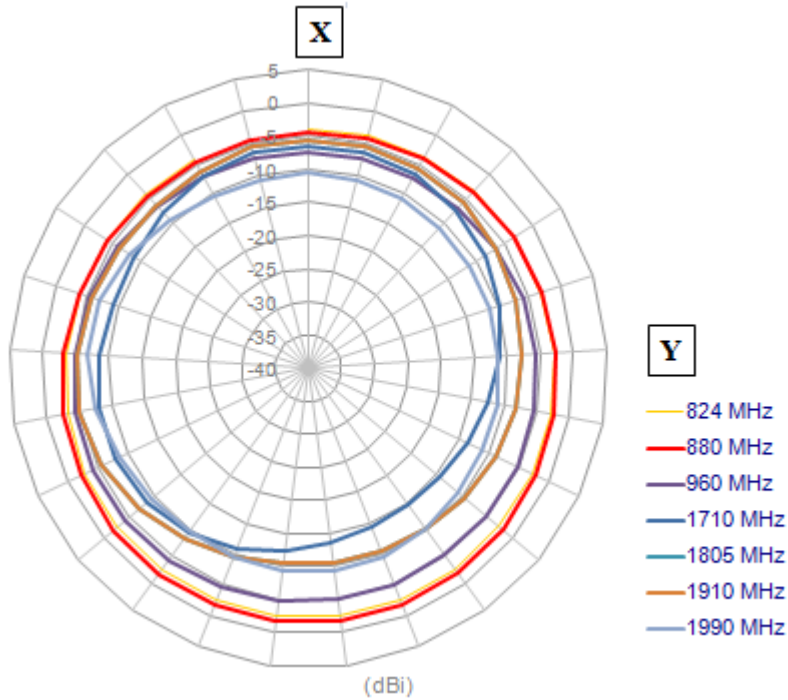

Figure 9. 3D Radiation Pattern at 1910 MHz (left), 1990 MHz (right) of the TG19 Antenna.

5.2. 2D Radiation pattern



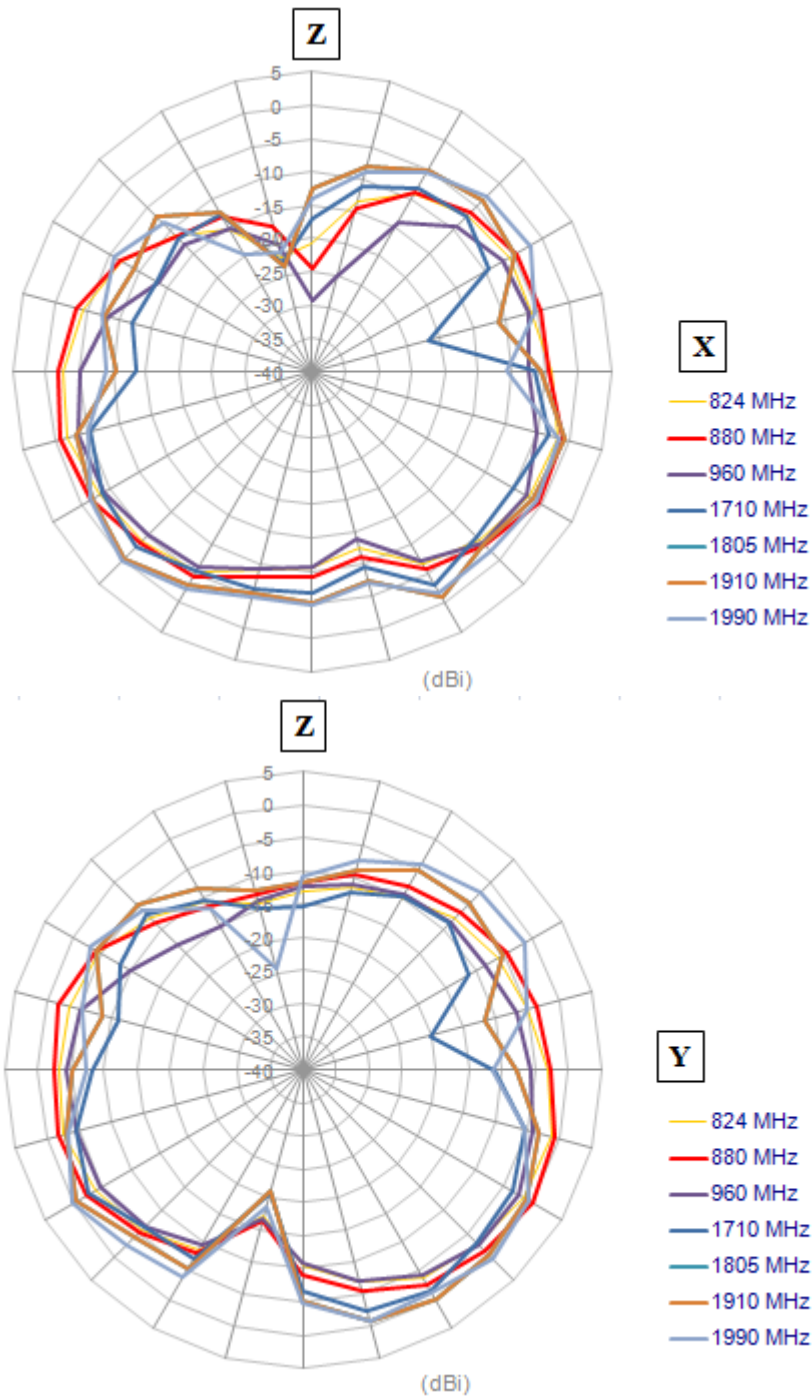
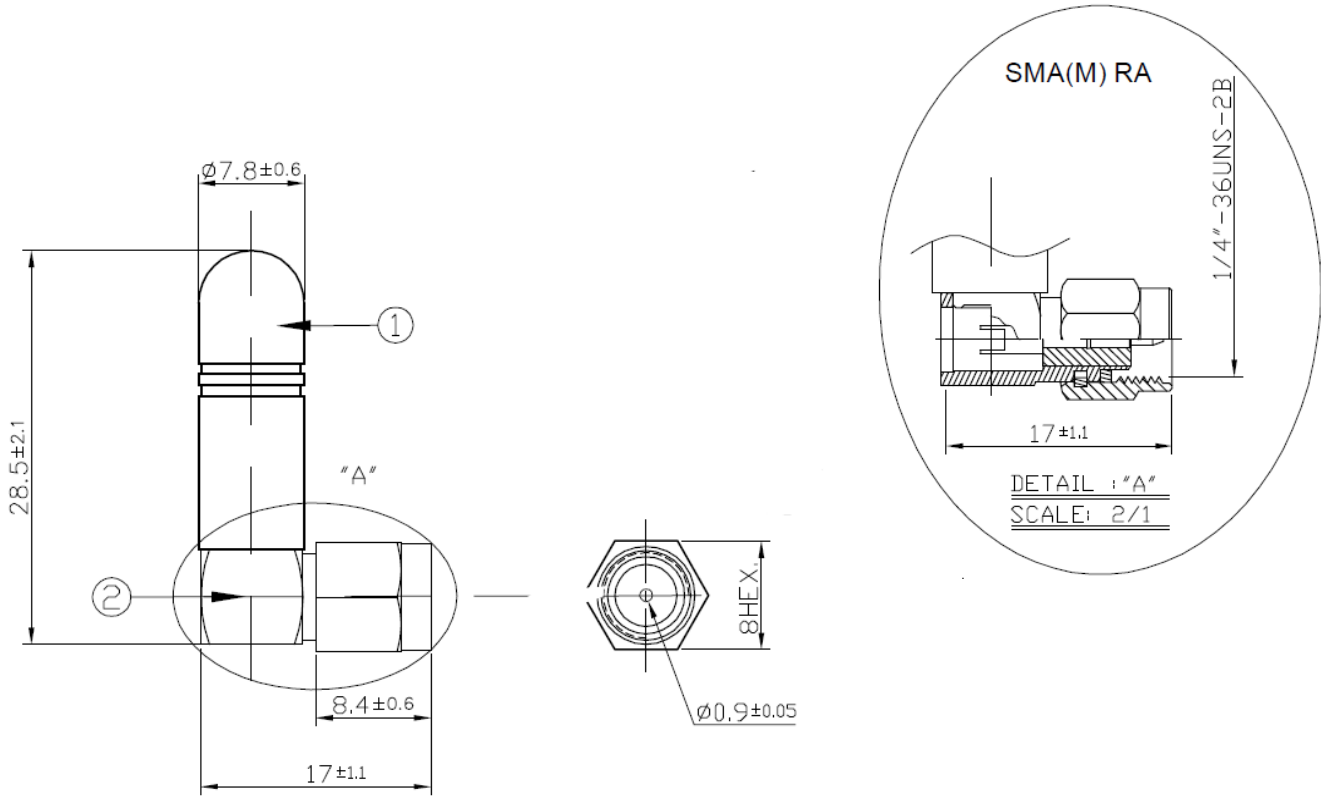

Figure 10. 2D Radiation Pattern of the TG19 Antenna.

6. Mechanical Drawing



	Name	P/N	Material	Finish	QTY
①	Antenna Housing	000111F010002A	TPU	Black	1
②	SMA(M) RA	210111K000002A	Brass	Gold	1

Figure 11. Mechanical Drawings of the TG19

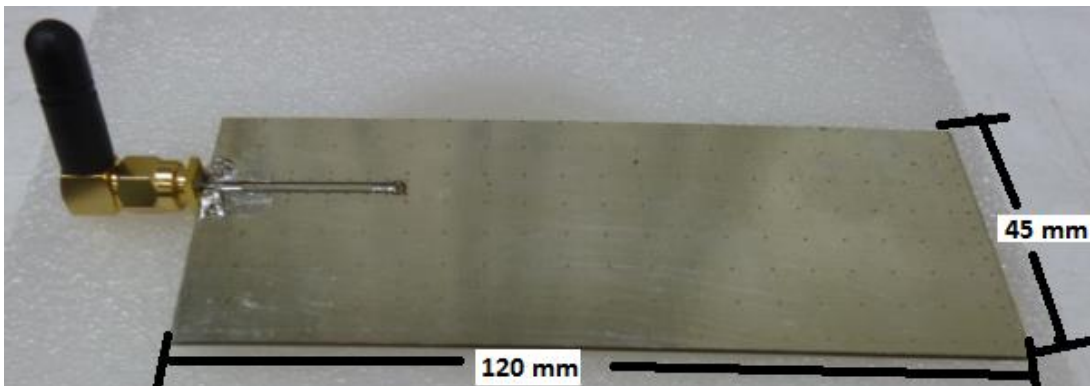

Figure 12. TG19 on the EVB

Taoglas makes no warranties based on the accuracy or completeness of the contents of this document and reserves the right to make changes to specifications and product descriptions at any time without notice. Taoglas reserves all rights to this document and the information contained herein. Reproduction, use or disclosure to third parties without express permission is strictly prohibited. Copyright © 2013, Taoglas Ltd.