

Installation and Technical Manual for the **Limitless™ Series WPMM Monitor** *used in conjunction with the Limitless™ Switch Series*

ISSUE 2
50051864

WARNING **PERSONAL INJURY**

- DO NOT USE these products as safety or emergency stop devices or in any other application where failure of the product could result in personal injury.

Failure to comply with these instructions could result in death or serious injury.

WARNING

Honeywell does not recommend using devices for critical control applications where there is, or may be, a single point of failure or where single points of failure may result in an unsafe condition. It is up to the end-user to weigh the risks and benefits to determine if the products are appropriate for the application based on security, safety and performance. Additionally, it is up to the end-user to ensure that the control strategy results in a safe operating condition if any crucial segment of the control solution fails.

Honeywell customers assume full responsibility for learning and meeting the required Declaration of Conformity, Regulations, Guidelines, etc. for each country in their distribution market.

Failure to comply with these instructions could result in death or serious injury.

WARNING **RF EXPOSURE**

- To satisfy FCC RF exposure requirements for mobile transmitting devices, a separation distance of 20 cm or more should be maintained between the antenna of this device and persons during device operation. To ensure compliance, operation at closer than this distance is not recommended. The antenna used for this transmission must not be co-located in conjunction with any other antenna or transmitter.

Failure to comply with these instructions could result in death or serious injury.

WARNING

- The WPMM must be installed in accordance with the requirements specified in this document. See Section 3&4 for EIRP requirements. Only the specified EIRP power settings, antenna types and gains and cable lengths (attenuation) as outlined in this document are valid for WPMM Series installations.

CAUTION

- Power to the WPMM should not be applied (ensure battery is removed) during installation of antenna as damage could occur to the WPMM electronics.

TABLE OF CONTENTS

TABLE OF CONTENTS..... II

LIST OF FIGURES..... VI

LIST OF TABLES 6

1 DESCRIPTION..... 1

 1.1 GENERAL..... 1

 1.2 PRINCIPLE OF OPERATION..... 1

 1.3 MODEL REFERENCE..... 1

 1.4 ABBREVIATIONS AND DEFINITIONS 2

 1.5 SYMBOL DEFINITIONS 3

2 SPECIFICATIONS 4

 2.1 INTENDED COUNTRY USAGE 4

 2.2 CERTIFICATION AND APPROVALS 5

 2.3 RADIO MODULE SPECIFICATIONS..... 5

 2.4 ELECTRICAL SPECIFICATIONS 5

 2.5 EMC SPECIFICATIONS..... 5

 2.6 ENVIRONMENTAL SPECIFICATIONS..... 6

 2.7 AGENCY COMPLIANCE INFORMATION..... 6

 2.7.1 *FCC Compliance Statements* 6

 2.7.2 *IC Compliance Statements* 6

 2.7.3 *Radio Frequency (RF) Safety Statement (FCC & IC)*..... 7

 2.7.4 *European Restrictions*..... 7

 2.8 EUROPEAN (CE) DECLARATION OF CONFORMITY (DOC) 8

 2.8.1 *European Declaration of Conformity Statements*..... 8

 2.8.2 *For more information about the R&TTE Directive* 9

3 EQUIVALENT ISOTROPICALLY RADIATED POWER (EIRP) 9

4 COUNTRY COMMUNICATION AGENCY EIRP LIMITS PER ANTENNA 10

5 QUICK START UP 11

 5.1 ANTENNA CONNECTION 11

 5.2 ELECTRICAL CONNECTIONS..... 12

 5.3 START-UP OR RE-START SEQUENCE 12

 5.4 PAIRING MODE..... 13

6 FUNCTIONAL INDICATORS AND MODES/DIAGNOSTICS 15

 6.1 PRINCIPLE OF OPERATION OF THE WPMM AND LIMITLESS™ SWITCH..... 15

 6.2 NORMAL OPERATION INDICATORS 17

 6.3 DIAGNOSTIC INDICATORS 17

 6.3.1 *Insufficient RF Link Indication*..... 17

 6.4 TROUBLESHOOTING MODE 18

 6.5 PAIRING MODE..... 19

 6.6 PURGE MODE..... 19

 6.7 FACTORY RESET MODE..... 19

 6.8 ABORT MODE 20

7 ANTENNA CONSIDERATIONS/OPTIONS AND MONITOR/ANTENNA INSTALLATION 21

 7.1 OVERVIEW OF ANTENNA OPTIONS..... 21

ii Honeywell Sensing and Control

- 7.1.1 *Omni-directional Antenna Design* 22
- 7.2 ANTENNA MOUNTING AND CONSIDERATIONS 23
 - 7.2.1 *Antenna Mounting Location with Respect to RF Signal*..... 23
 - 7.2.2 *Outdoor Installation Warnings* 24
 - 7.2.3 *Antenna Connection, Styles, and Mounting Options* 25
 - 7.2.3.1 *Antenna Connection*..... 25
 - 7.2.3.2 *Antenna Styles and Mounting Options*..... 25
 - 7.2.4 *Antenna Adjustment Considerations* 28
- 7.3 ESTIMATING RANGE OF AN ANTENNA..... 28
- 7.4 CHOOSING AN ANTENNA GAIN (DBI) WITH ACCEPTABLE FADE-MARGIN 29
- 7.5 ENVIRONMENTAL USAGE/CONCERNS 30
 - 7.5.1 *Choosing an Antenna/Cable to Meet Application Exposure Conditions*..... 30
 - 7.5.2 *Outdoor Antenna Installations - Lightning Concerns* 30
 - 7.5.3 *RF Interference* 31
- 7.6 PANEL MOUNTING 31
- 8 INSPECTION AND MAINTENANCE 32**
 - 8.1 WPMM INSPECTION AND REPLACEMENT 32
 - 8.2 ANTENNA INSPECTION AND REPLACEMENT 32
- 9 ACCESSORIES..... 33**
 - 9.1 ANTENNA OPTIONS 33
 - 9.2 ANTENNA CABLE OPTIONS 34
 - 9.3 MOUNTING OPTIONS 35
- 10 INSTALLATION DRAWINGS..... 36**
 - 10.1 DRAWING AVAILABILITY 36
- 11 TROUBLESHOOTING GUIDES 37**

LIST OF FIGURES

Figure 1. European Declaration of Conformity (DoC) 8
Figure 2. Limitless™ WPMM terminals 12
Figure 3. Limitless™ Switch Housing 14
Figure 4. Limitless™ Switch Housing 14
Figure 5. Limitless™ Switch with Function Button Depressed 14
Figure 6. Limitless™ Switch Label Placement 14
Figure 7. WPMM Operation and LED Functions Chart – part 1 15
Figure 8. WPMM Operation and LED Functions Chart – part 2 16
Figure 9. Limitless™ WPMM LED display 17
Figure 10. Limitless™ WPMM LED Display 18
Figure 11. Limitless™ WPMM LED Display 20
Figure 12. Radiation Pattern of an Omni-directional Antenna 22
Figure 13. Limitless™ switch to WPMM Antennas with RF Signal Line of Sight Free From Obstacles 23
Figure 14. Limitless™ switch to WPMM Antennas with RF Signal Line of Sight Affected by Obstacles 23
Figure 15. Limitless™ WPMM RP-SMA Connection, Integral 25
Figure 16. Limitless™ WPMM RP-SMA Connection, Remote 25
Figure 17. Straight and Tilt/Swivel antennas 26
Figure 18. Adhesive Mount Antenna – Step 1. Pre-clean the surface 26
Figure 19. Adhesive Mount Antenna – Step 2. Peel Protection from Adhesive Strip 26
Figure 20. Adhesive Mount Antenna – Step 3. Mount the Antenna 26
Figure 21. Mast Mount Antenna – Tighten nut on mounting bracket 27
Figure 22. Mast Mount Antenna – Side View with Attachment to Pipe 27
Figure 23. Magnetic Mount Bracket with Antenna – Mounted on Steel Surface 28
Figure 24. Highest RF signal when antennas are as parallel to each other as possible 28
Figure 24. WPMM Panel Mount – Back View 31
Figure 25. WPMM Panel Mount – Back View In Place 31
Figure 26. WPMM Panel Mount – Front View 31

LIST OF TABLES

Table 1 –Table of Abbreviations and Definitions 2
Table 2 –Table Symbol Definitions 3
Table 3 – North America 4
Table 4 – Asia Pacific 4
Table 5 – European Union 4
Table 6 – Other European Countries 4
Table 7 – Approvals and Ratings 5
Table 8 – Radio Module Specifications 5
Table 9 – Electrical Specifications 5
Table 10 – Environmental Specifications 6
Table 11 – Country Communication Agency EIRP Limits Per Antenna 10
Table 12 – Cable/Connector Loss Per Antenna Type for the WPMM Series 10

1 DESCRIPTION

1.1 General

The new Limitless™ Series uses the latest commercial off-the-shelf wireless technology to be used for a wide variety of applications. This is especially beneficial for remote monitoring applications where previous wiring or wire maintenance was not physically possible or economically feasible. This document will provide installation instructions to properly install a Limitless™ Wireless Panel Mount Monitor (WPMM), as well as a detailed understanding of its functions.

1.2 Principle of Operation

A Limitless™ switch sends an RF signal to the WPMM when the actuator of a switch changes position. There may be up to 16 Limitless™ switches that communicate and thus indicate actuation position to a single WPMM. The actuation (free position to full overtravel) of any one of the Limitless™ switches causes a single red output LED to illuminate, a buzzer to sound, and a change in the NPN output. However, there is no differentiation of outputs (visual, audible, or NPN state change) between Limitless™ switches (up to 16) as there is only one output that all Limitless™ switches share. Further, if a Limitless™ switch is actuated and causes the single red output LED to illuminate, a buzzer to sound and a change in the NPN output, actuation of another Limitless™ switch(s) will not cause another output change (visual, audible or NPN state change). The WPMM also indicates a low battery condition, insufficient RF link, as well as other diagnostic and functional operations that are described in further detail throughout this manual.

1.3 Model Reference

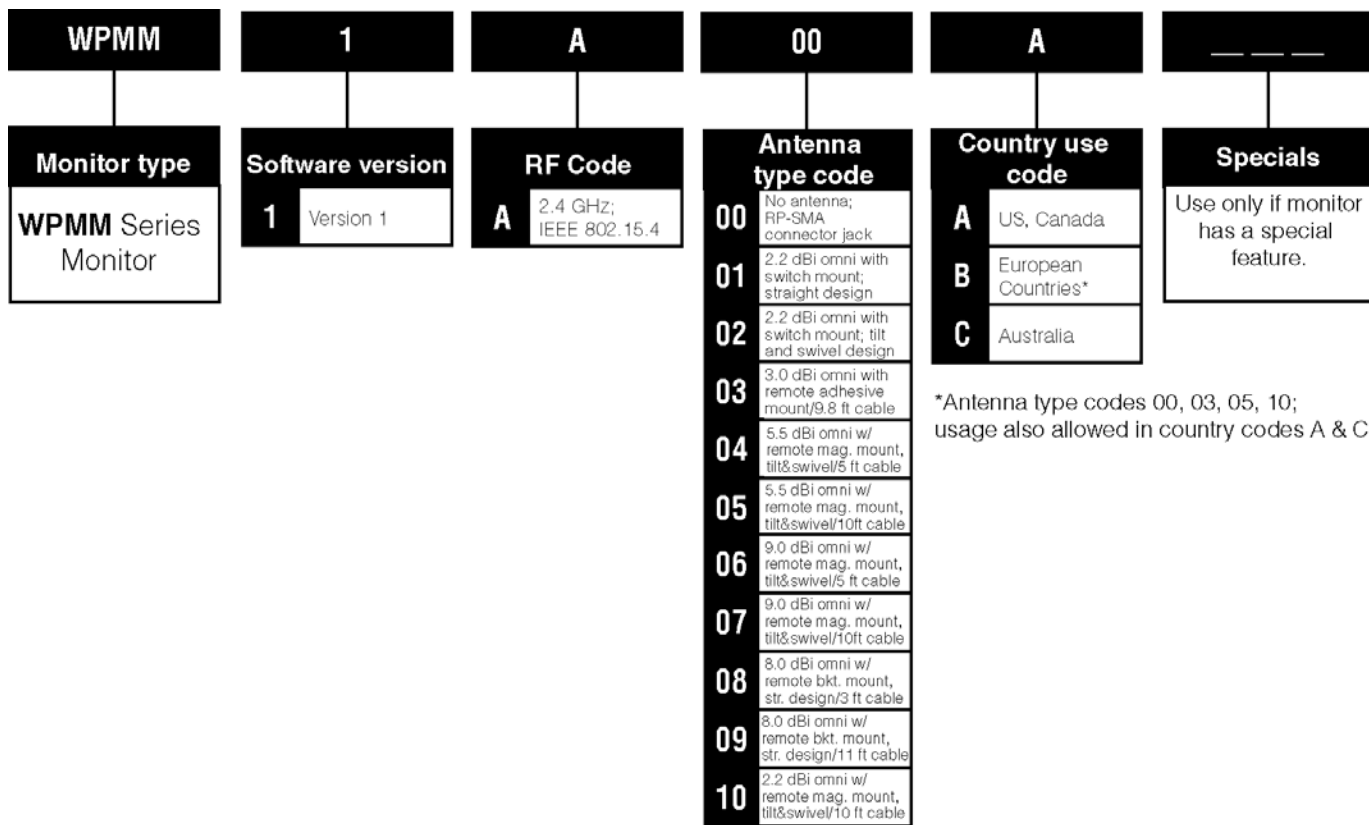

1.4 Abbreviations and Definitions













Table 1 –Table of Abbreviations and Definitions

ACMA	Australian Communications and Media Authority
dB	Decibel
dBi	Decibel Isotropic
dBm	Decibel above or below 1 milliwatt
DSSS	Direct Sequence Spread Spectrum
EIRP	Equivalent isotropic radiated power
EMC	Electromagnetic Compatibility
ETSI	European Telecommunications Standards Institute
EU	European Union
FCC	Federal Communications Committee
ft-lbs	Foot-pounds
GHz	GigaHertz
IC	Industry Canada
ICES	Industry Canada Electrical Specification
IEEE	Institute of Electrical and Electronics Engineers
kbps	KiloBits Per Second
LED	Light Emitting Diode
MHz	MegaHertz
MPE	Maximum Permissible Exposure
NA	North America – United States of America and Canada
NEMA	National Electrical Manufacturers Association
R&TTE	Radio and Telecommunications Terminal Equipment
RP-SMA	Reverse Polarity SMA connector
RF	Radio Frequency
TX	Transmit
WGLA	Wireless Global Limit Switch Series
WPMM	Wireless Panel Mount Monitor Series

1.5 Symbol Definitions

The following table lists those symbols used in this document to denote certain conditions.

Table 2 –Table Symbol Definitions

Symbol	Definition
	ATTENTION: Identifies information that requires special consideration.
	TIP: Identifies advice or hints for the user, often in terms of performing a task.
CAUTION	Indicates a situation which, if not avoided, may result in equipment or work (data) on the system being damaged or lost, or may result in the inability to properly operate the process.
	CAUTION: Indicates a potentially hazardous situation which, if not avoided, may result in minor or moderate injury. It may also be used to alert against unsafe practices. CAUTION symbol on the equipment refers the user to the product manual for additional information. The symbol appears next to required information in the manual.
	WARNING: Indicates a potentially hazardous situation, which, if not avoided, could result in serious injury or death. WARNING symbol on the equipment refers the user to the product manual for additional information. The symbol appears next to required information in the manual.
	WARNING, Risk of electrical shock: Potential shock hazard where HAZARDOUS LIVE voltages greater than 30 Vrms, 42.4 Vpeak, or 60 Vdc may be accessible.
	ESD HAZARD: Danger of an electro-static discharge to which equipment may be sensitive. Observe precautions for handling electrostatic sensitive devices.
	Protective Earth (PE) terminal: Provided for connection of the protective earth (green or green/yellow) supply system conductor.
	Functional earth terminal: Used for non-safety purposes such as noise immunity improvement. NOTE: This connection shall be bonded to Protective Earth at the source of supply in accordance with national local electrical code requirements.
	Earth Ground: Functional earth connection. NOTE: This connection shall be bonded to Protective Earth at the source of supply in accordance with national and local electrical code requirements.
	Chassis Ground: Identifies a connection to the chassis or frame of the equipment shall be bonded to Protective Earth at the source of supply in accordance with national and local electrical code requirements.
	C-Tick Mark. The C-Tick Mark is a certification trade mark registered to ACMA (Australian Communications and Media Authority) in Australia under the Trade Marks Act 1995 and to RSM in New Zealand under section 47 of the NZ Trade Marks Act. The mark is only to be used in accordance with conditions laid down by ACMA and RSM. This mark is equal to the CE Mark used in the European Union.
	Notified Body. For radio equipment used in the European Union in accordance with the R&TTE Directive, the CE Mark and the notified body (NB) identification number is used when the NB is involved in the conformity assessment procedure. The alert sign must be used when a restriction on use (output power limit by a country at certain frequencies) applies to the equipment and must follow the CE marking.

2 SPECIFICATIONS

2.1 Intended Country Usage

Table 3 – North America

Country	ISO 3166 2 letter code
UNITED STATES	US
CANADA	CA

Table 4 – Asia Pacific

Country	ISO 3166 2 letter code
AUSTRALIA	AU

Table 5 – European Union

Country	ISO 3166 2 letter code	Country	ISO 3166 2 letter code
Austria	AT	Latvia	LV
Belgium	BE	Lithuania	LT
Bulgaria	BG	Luxembourg	LU
Cyprus	CY	Malta	MT
Czech Republic	CZ	Netherlands	NL
Denmark	DK	Poland	PL
Estonia	EE	Portugal	PT
Finland	FI	Romania	RO
France	FR	Slovak Republic	SK
Germany	DE	Slovenia	SI
Greece	GR	Spain	ES
Hungary	HU	Sweden	SE
Ireland	IE	United Kingdom	BG
Italy	IT		

Table 6 – Other European Countries

Country	ISO 3166 2 letter code	Country	ISO 3166 2 letter code
Bosnia and Herzegovina	BA	Norway	NO
Croatia	HR	Russian Federation	RU
Iceland	IS	Serbia	RS
Liechtenstein	LI	Switzerland	CH
Macedonia	MK	Turkey	TR

2.2 Certification and Approvals

See the product label for applicable approvals and ratings.

Table 7 – Approvals and Ratings

Approval/Item	Ratings/Description
Enclosure Type	IP67
Federal Communications Commission (FCC)	FCC Part 15.247
Industry Canada (IC)	Canadian ICES-003
European Telecommunications Standards Institute (ETSI)	CE mark
Australian Communications and Media Authority (ACMA)	C-Tick mark

2.3 Radio Module Specifications

Table 8 – Radio Module Specifications

Item	Specification
Wireless standard	WPAN IEEE 802.15.4 Direct Sequence Spread Spectrum (DSSS), 2.4 GHz
Data rate	250 kbps
Operating Frequency	ISM 2.4 GHz
Module transmit power	18 dBm or 10 dBm (Maximum transmit power will vary by country usage requirements)
Receive sensitivity (typ.)	-100 dBm
# of pairing (max.)	Up to 16 Limitless™ limit switches can be paired to a single WPMM

 **WARNING**

* The WPMM must be installed in accordance with the requirements specified in this document. See Section 3 and Section 4 for EIRP requirements. Only the specified EIRP power settings, antenna types and gains and cable lengths (attenuation) as outlined in this document are valid for WPMM Series installations.

2.4 Electrical Specifications

Table 9 – Electrical Specifications

Item	Specification
Supply voltage	10 Vdc to 30Vdc
Supply current	750 mA max.
Output type	NPN current sinking, normally open
Load current	5 mA to 200 mA
Leakage current	50 uA max.
Voltage drop	1.75 Vdc max. @ max. load @ 25 °C [77°F]
Termination	Three quick connect, 0.25 inch male blade

2.5 EMC Specifications

The latest applicable EMC Standards are as follows:

- EN 300 328, V1.7.1
- EN 61326-1 (2006)
- EN 301 489-1, V1.8.1
- EN 301 489-17, V2.1.1

2.6 Environmental Specifications

Table 10 – Environmental Specifications

Item	Specification
Operating temperature	-40 °C to 85 °C [-40 °F to 185 °F]
Storage temperature	-40 °C to 85 °C [-40 °F to 185 °F]
Operating humidity	0 %RH to 100 %RH

2.7 Agency Compliance Information

2.7.1 FCC Compliance Statements

- This device complies with Part 15 of FCC Rules and Regulations. Operation is subject to the following two conditions: (1) This device may not cause harmful interference and (2) this device must accept any interference received, including interference that may cause undesired operation.
- This equipment has been tested and found to comply with the limits for a Class B digital device, pursuant to Part 15 of the FCC Rules. These limits are designed to provide reasonable protection against harmful interference in a residential installation. This equipment generates, uses, and can radiate radio frequency energy and, if not installed and used in accordance with these instructions, may cause harmful interference to radio communications. Operation of this equipment in a residential area is likely to cause harmful interference in which case the user will be required to correct the interference at his/her own expense.
- Intentional or unintentional changes or modifications must not be made to the WPMM unless under the express consent of the party responsible for compliance. Any such modifications could void the user’s authority to operate the equipment and will void the manufacturer’s warranty.

2.7.2 IC Compliance Statements

- To reduce potential radio interference to other users, the antenna type and its gain should be chosen so that the equivalent isotropic radiated power (EIRP) is not more than that permitted for successful communication.
- Operation is subject to the following two conditions: (1) this device may not cause interference, and (2) this device must accept any interference, including interference that may cause undesired operation of the device.
- This Class B digital apparatus has been tested and found to comply with Canadian ICES-003.
- French: Cet appareil numérique de la classe B est conforme à la norme NMB-003 du Canada.

2.7.3 Radio Frequency (RF) Safety Statement (FCC & IC)

To comply with FCC's and Industry Canada's RF exposure requirements, the following antenna installation and device operating configurations must be satisfied.

- Remote antenna for this unit must be fixed and mounted on outdoor permanent structures with a separation distance between any other antenna(s) of greater than 20cm and a separation distance of at least 20 cm [7.87 in] from all persons.
- Furthermore, when using an integral antenna with the WPMM, it must not be co-located with any other antenna or transmitter device and have a separation distance of at least 20 cm [7.87 in] from all persons.

2.7.4 European Restrictions

- Information regarding national restrictions can be found in document: ERC/REC 70-03 (Relating to the use of short-range devices including appendixes and annexes). Documentation may be found in the document database in the European Communication's office.
 - <http://www.erodocdb.dk/doks/dochistory.aspx?docintid=1622>

2.8 European (CE) Declaration of Conformity (DoC)

2.8.1 European Declaration of Conformity Statements

This section contains the European Declaration of Conformity (DoC) statement for the radio used in the Limitless™ WPMM monitor.

Figure 1. European Declaration of Conformity (DoC)



Honeywell Control Systems Ltd.,
Newhouse Industrial Estate,
Motherwell, Lanarkshire, ML1 5SB,
Scotland, United Kingdom.

Tel.: +44 (0)1698 481000
Fax: +44 (0)1698 481011

A subsidiary of Honeywell Control Systems Ltd.,
Registered Office: Honeywell House,
Arlington Business Park,
Bracknell, Berkshire,
R12 1EB.
Registered No 217808 (England)

EC Declaration of Conformity

Honeywell Control Systems Ltd. hereby declare that the products identified below conform to the essential requirements of the EC Directive(s) listed below and that the products supplied are in conformity with the type described in any EC Type Examination Certificate (EC TEC) identified below.

Manufacturer: Honeywell International, MICRO SWITCH Division
11309 West Chetlain Lane, Galena, Illinois,
IL 61036-0327, USA
Product: Limit Switch
WGLA and WPMM Wireless Limit Switch and Monitor

<u>Directive (Amendments)</u>	<u>Conformity Details</u>	
LVD 2006/95EC	Standards applied:	EN 61010-1: 2001 + A2:2005
1999/5/EC and 2004/108/EC	Standards applied:	EN 61326-1:2006 ETSI EN 300 328 V1.7.1 ETSI EN 301 489-1 V1.8.1 and -17 V2.1.1

Signed on behalf of Honeywell Control Systems Ltd. :

Frank Turnbull, S&C Chief Engineer

DoC No: A434

DoC Issue: 1

DoC Date: 08/04/2010

Page 1 of 1

2.8.2 For more information about the R&TTE Directive

The following website contains additional information about the Radio and Telecommunications Terminal Equipment (R&TTE) directive:

<http://ec.europa.eu/enterprise/sectors/rtte/faq/>

3 EQUIVALENT ISOTROPICALLY RADIATED POWER (EIRP)

In radio communication systems, Equivalent Isotropically Radiated Power (EIRP) or, alternatively, Effective Isotropic Radiated Power, is the amount of power that would have to be emitted by an isotropic antenna (that evenly distributes power in all directions and is a theoretical construct) to produce the peak power density observed in the direction of maximum antenna gain. EIRP can take into account the losses in transmission line and connectors and includes the gain of the antenna. The EIRP is often stated in terms of decibels over a reference power level that would be the power emitted by an isotropic radiator with equivalent signal strength. The EIRP allows making comparisons between different emitters regardless of type, size or form. From the EIRP, and with knowledge of a real antenna's gain, it is possible to calculate real power and field strength values.

Values found in Tables 11 and 12.

EIRP (dBm) = Max. Radio Output Power (dBm) – Cable/Connector Loss (dB) + Antenna Gain (dBi)

EIRP Example for WPMM Series:

5.5 dBi Omni remote antenna used in ETSI/European Countries including France restriction

EIRP = 8 dBm – 4.28 dB + 5.5 dBi

EIRP = 9.22 dBm (value is less than the max. EIRP allowed of 10.00 dBm)

Antenna gain is expressed relative to a (theoretical) isotropic reference antenna (dBi).

4 COUNTRY COMMUNICATION AGENCY EIRP LIMITS PER ANTENNA

Table 11 – Country Communication Agency EIRP Limits Per Antenna

Antenna Type Code	Antenna Max. Gain/Type	Radio usage	Application Mounting	Agency/country	Max. radio output power (dBm)	Max. EIRP (dBm)
01, 02, 10	2.2 dBi Omni	Point to point	Integral* or Remote**	FCC, IC/USA, Canada	18	36.00
01, 02, 10	2.2 dBi Omni	Point to point	Integral* or Remote**	ACMA/Australia	8	19.24
01, 02, 10	2.2 dBi Omni	Point to point	Integral* or Remote**	ETSI/European Countries	8	10.00***
03	3.0 dBi Omni	Point to point	Remote*	FCC, IC/USA, Canada	18	36.00
03	3.0 dBi Omni	Point to point	Remote*	ACMA/Australia	8	19.24
03	3.0 dBi Omni	Point to point	Remote*	ETSI/European Countries	8	10.00***
04, 05	5.5 dBi Omni	Point to point	Integral** or Remote**	FCC, IC/USA, Canada	18	36.00
04, 05	5.5 dBi Omni	Point to point	Integral** or Remote**	ACMA/Australia	8	19.24
05	5.5 dBi Omni	Point to point	Remote**	ETSI/European Countries	8	10.00***
08, 09	8.0 dBi Omni	Point to point	Remote*	FCC, IC/USA, Canada	18	36.00
08, 09	8.0 dBi Omni	Point to point	Remote*	ACMA/Australia	8	19.24
06, 07	9.0 dBi Omni	Point to point	Integral** or Remote**	FCC, IC/USA, Canada	18	36.00
06, 07	9.0 dBi Omni	Point to point	Integral** or Remote**	ACMA/Australia	8	19.24

* Indoor or outdoor use

** Indoor or limited outdoor exposure. Protect against direct rain, salt, snow, ice, etc.

*** Based on France outdoor restriction

Table 12 – Cable/Connector Loss Per Antenna Type for the WPMM Series

Antenna Type Code	Min. Cable/Connector Loss (dB)
01	0.15
02	0.15
03	4.33
04	2.29
05	4.28
06	2.29
07	4.28
08	1.08
09	2.43
10	4.28

EIRP Example for WPMM Series: 5.5 dBi Omni remote antenna used in ETSI/European Countries including France restriction

EIRP (dBm) = Max. Radio Output Power (dBm) – Min. Cable/Connector Loss (dB) + Max. Antenna Gain (dBi)
 Values found in Tables 11 and 12.

EIRP = 8 dBm – 4.28 dB + 5.5 dBi

EIRP = 9.22 dBm (value is less than the max. EIRP allowed of 10.00 dBm)



ATTENTION

If using the WPMM in a portable application (for example, the WPMM is used in a handheld device and the antenna is less than 20 cm from the human body when the device is in operation): The integrator is responsible for passing additional SAR (Specific Absorption Rate) testing based on FCC rules 2.1091 and FCC Guidelines for Human Exposure to Radio Frequency Electromagnetic Fields, OET Bulletin and Supplement C. The testing results will be submitted to the FCC for approval prior to selling the integrated unit. The required SAR testing measures emissions from the module and how they affect the person.

Notes for Table 11:

1. Antennas listed in this chart are approved for use with the Digi International XBee –PRO® RF Module which the WPMM utilizes.
2. The following shall apply for antenna type, frequency range, application/usage and agency/country compliance:
 - Antenna gains above the maximum values shown shall not be used.
 - Cable length/loss below the minimum values shown shall not be used.
 - Maximum overall radio output power shown shall not be exceeded.
 - Maximum EIRP values shown above shall not be exceeded.
3. Industry Canada Compliance Statement: This device has been designed to operate with the antenna types listed in this document, and having a maximum gain of 9 dBi. Antenna types not included in this list or having a gain greater than 9 dBi are strictly prohibited for use with this device. The required antenna impedance is 50 Ohm.

5 QUICK START UP

5.1 Antenna Connection

⚠ WARNING

RF EXPOSURE

* To satisfy FCC RF exposure requirements for mobile transmitting devices, a separation distance of 20 cm [7.87 in] or more should be maintained between the antenna of this device and persons during device operation. To ensure compliance, operation at closer than this distance is not recommended. The antenna used for this transmission must not be co-located in conjunction with any other antenna or transmitter.

Failure to comply with these instructions could result in death or serious injury.

CAUTION

* Power to the WPMM should not be applied (ensure battery is removed) during installation of antenna as damage could occur to the WPMM electronics.

The antenna and antenna guard are packaged separately and thus will need to be assembled to the WPMM.

A **direct mount antenna** (either straight or tilt & swivel) can be easily mounted by threading the mating RP-SMA plug of the antenna to the RP-SMA jack on the WPMM. Tighten the connection until finger tight. Then, attach the antenna guard by simply threading the guard finger tight onto the threaded base with the RP-SMA connector.

A **remote mount antenna** requires the use of an extension cable to allow the antenna to be mounted in a different location than the WPMM location. The extension cable will need to have one end with a RP-SMA plug connector which will mate with the WPMM connector jack under the same mounting procedure as the direct mount antenna. The other end of the extension cable will need to mate with antenna connector directly.

Refer to Section 7.3 for further information regarding installation.

5.2 Electrical Connections

WARNING

RISK OF ELECTRICAL SHOCK

* Potential shock hazard where HAZARDOUS LIVE voltages greater than 30 Vrms, 42.4 Vpeak, or 60 Vdc may be accessible.

Failure to comply with these instructions could result in death or serious injury.

ATTENTION

Do not run the electrical wires in parallel and close proximity to the antenna or antenna cable.

Power supply connections: The WPMM has three 0.25 in quick connect terminals on the bottom of the housing. A regulated voltage supply of 10 Vdc to 30 Vdc needs to be connected to the terminals identified with a “V+” and “V-”. See Figure 2.

NPN output connections (optional): The WPMM is supplied with a NPN normally open current sinking output. The customer has the option of connecting their NPN current sinking-compatible circuitry to the terminals identified with an “OUT” and “V-”. See Figure 3.

Figure 2. Limitless™ WPMM terminals



5.3 Start-up or Re-start Sequence

Turn-on the power to the “V+” and “V-” terminals (after proper connection described in Section 5.2) which will initiate a check of the LEDs and buzzer on the WPMM. If properly working, red, amber, and green LEDs illuminate along with the buzzer sounding for approximately three seconds.

The following describes how the WPMM LEDs will indicate that the WPMM is ready for use:

Zero switches paired (per Section 5.4) to the WPMM: The green LED will illuminate indicating power is being supplied to the WPMM and the unit is ready to use.

One or more switches paired (per Section 5.4) to the WPMM: The WPMM will enter a System Check Mode for up to two minutes. The red, amber, and green LEDs illuminate sequentially until the system check is successfully completed at which time the green LED will illuminate indicating power is being supplied to the WPMM and the unit is ready to use.

ATTENTION

If there are multiple WPMMs being used in the application, apply power to previously paired WPMMs first (if any) and then to one WPMM at a time. **Allow time for each WPMM to complete its start-up sequence before applying power to the next WPMM.**

5.4 Pairing Mode

Pairing is required to initiate and establish an RF communication link between each single Limitless™ switch and a single WPMM. The Limitless™ switch will be shipped from the factory with two identification labels ① that are recommended to be completed and applied to the Limitless™ switch housing during the pairing mode. As there are up to 16 Limitless™ switches that can be paired to a single WPMM, these labels will be used to identify the Limitless™ switch in the sequence of #1 to #16. The initial Limitless™ switch paired to the WPMM will be Sequence #1, the second Limitless™ switch paired will be Sequence #2 and so on. If replacing a Limitless™ switch that has been purged (see section 6.5), identify the correct replacement Sequence # on the identification labels.



ATTENTION

If there are multiple WPMMs being used in the application, apply power to previously paired WPMMs first (if any) and then to one WPMM at a time. **Allow time for each WPMM to complete its start-up sequence before applying power to the next WPMM.**



ATTENTION

The purging of a Limitless™ switch is required when a previously paired Limitless™ switch is to be paired again. Refer to the Limitless™ switch installation and technical manual for purge mode information for the particular model of Limitless™ switch.

The battery will need to be activated in the Limitless™ switch and proper power applied to the WPMM (green ② LED illuminated) before proceeding with this pairing procedure. Once the pairing is completed, the Limitless™ switch selected will only communicate with the WPMM it was paired to and no other device.

Step	Action
1	Completely read this procedure before starting in order to understand the timing of events that need to be performed.
2	Limitless™ switch: Remove (if required) the two screws ⑥ on the housing cover of the Limitless™ switch (see Figure 3) and locate the function button ⑦ (see Figure 5) to be used in Step 4.
3	WPMM: Press the Function button ④ on WPMM (see Figure 4) for more than four seconds and less than eight seconds at which time the green ② and amber ③ LEDs (see Figure 4) will be flashing which indicates to release the function button immediately as it has entered the pairing mode.
4	Limitless™ switch: Within a 30 second interval of Step 3, depress the function button ⑦ and hold depressed for more than one second and less than 12 seconds at which time the orange ⑧ LED turns on (see Figure 5). While in pairing mode, the orange led will flash on for 100 ms every second. The orange ⑧ LED flashes three times 100 ms on, 100 ms off when pairing succeeds. If pairing does not succeed, the orange ⑧ LED will turn off and user will need to repeat steps starting with Step #3.
5	WPMM: Successful pairing will be indicated by the green ② and amber ③ LEDs ceasing to flash and remaining on for a few seconds before turning off. A short buzzer beep will also occur.
6	To confirm proper pairing between the Limitless™ switch and WPMM, actuate the Limitless™ switch, and the red LED ⑤ (see Figure 4) should illuminate along with a buzzer sound.
7	Record the Limitless™ sequence # on identification labels ① and apply to the Limitless™ housing in desired locations (See Figure 6).
8	Repeat Steps 2-7 to add additional Limitless™ switches. Up to 16 Limitless™ switches can be paired to a single WPMM.



ATTENTION

The WPMM will go back to normal operation after 35 seconds if pairing does not occur.

Figure 3. Limitless™ Switch Housing



Figure 4. Limitless™ Switch Housing



NOTE: Use a blunt object, such as a paper clip or tooth pick to actuate the function switch ④.

Figure 5. Limitless™ Switch with Function Button Depressed



NOTE: Use a blunt object, such as a paper clip or tooth pick to actuate the function switch ⑦.

Figure 6. Limitless™ Switch Label Placement



6 FUNCTIONAL INDICATORS AND MODES/DIAGNOSTICS

The operation and LED functions for the WPMM are visually depicted and described below. These graphics are also located as a separate file on this CD or at www.honeywell.com/sensing.

6.1 Principle of Operation of the WPMM and Limitless™ Switch

A Limitless™ switch will send an RF signal to the WPMM when the actuator of the switch changes position. There are up to 16 Limitless™ switches that will communicate and thus indicate their actuation position with a single WPMM. The actuation (Free Position to Full Overtravel) of any one of the Limitless™ switches will cause a single red output LED to illuminate, a buzzer to sound and a change in the NPN output. However, there will be no differentiation of outputs (visual, audible or NPN state change) between the Limitless™ switches (up to 16) being actuated. Further, if a Limitless™ switch is actuated and thus causes the single red output LED to illuminate, a buzzer to sound and a change in the NPN output, actuation of another Limitless™ switch(s) will not cause another output change (visual, audible or NPN state change). A further detailed description of each function is defined in the following sections.

Figure 7. WPMM Operation and LED Functions Chart – part 1

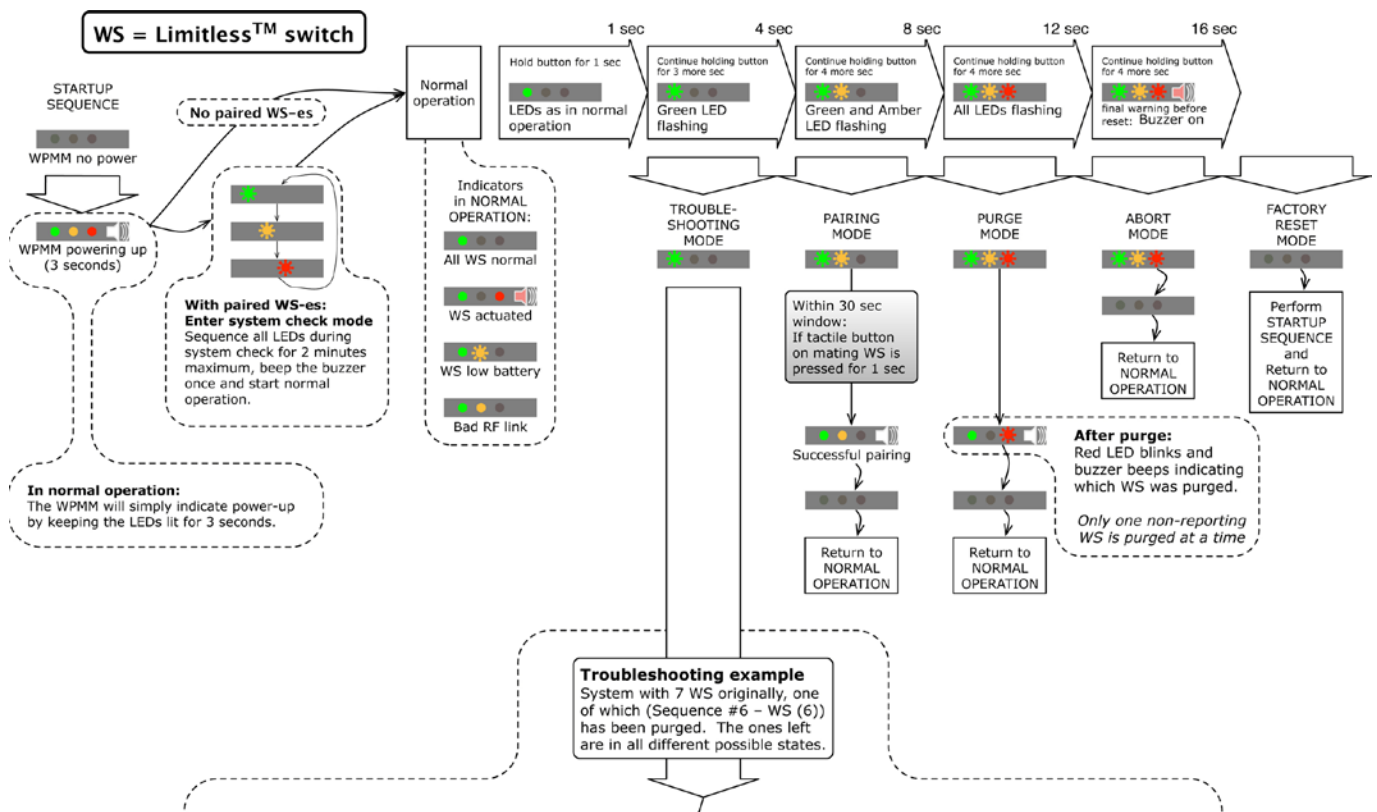
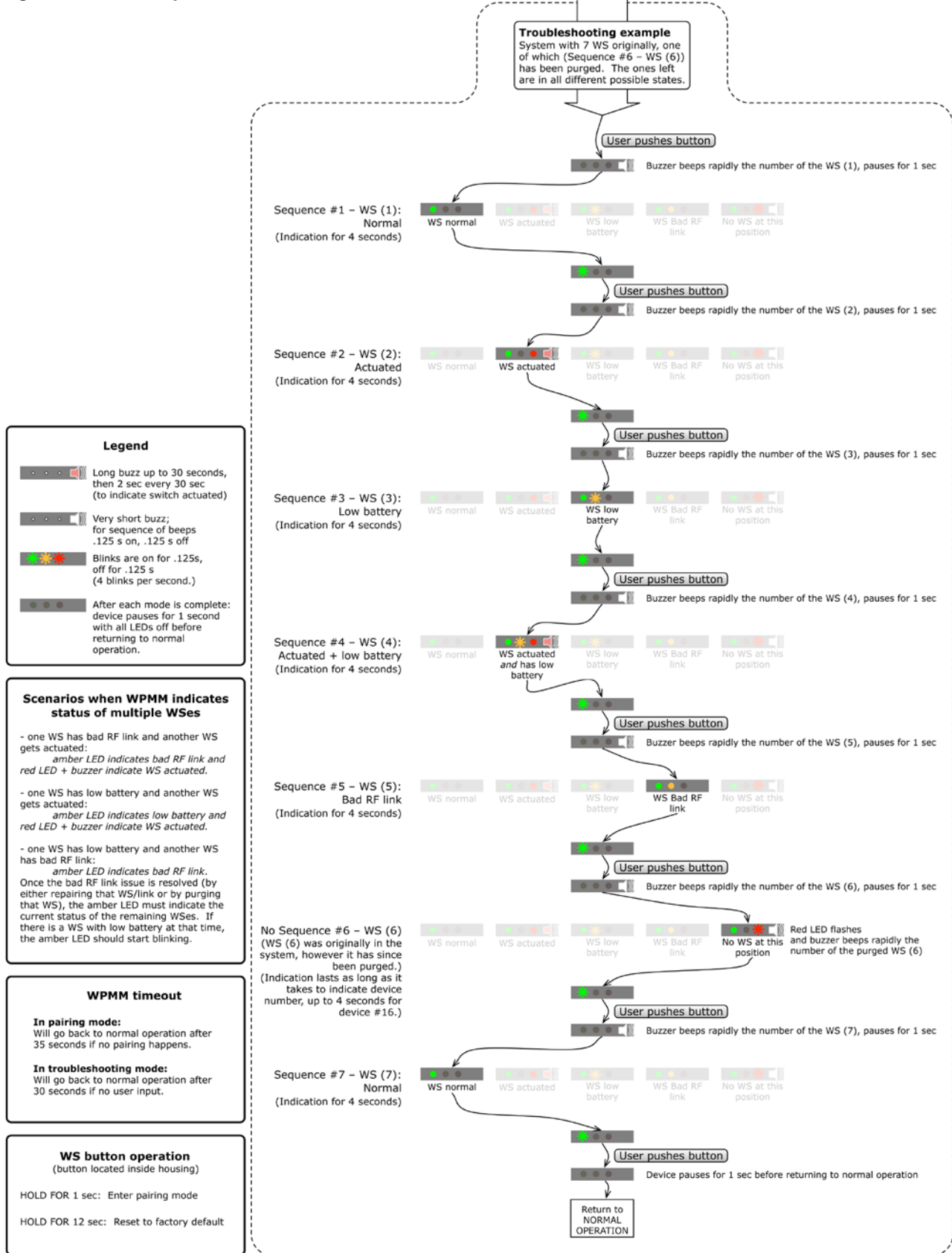

Figure 8. WPMM Operation and LED Functions Chart – part 2



6.2 Normal Operation Indicators

WPMM LED Display: Green ② LED illuminated only: This indicates that there is power applied to the WPMM and that none of the Limitless™ switches are activated.

WPMM LED Display: Green ② and red ⑤ LEDs illuminated with buzzer initially on for 30 seconds and then on two seconds every 30 seconds. This indicates that there is power applied to the WPMM and that one or more of the Limitless™ switches have been activated.

6.3 Diagnostic Indicators

WPMM LED Display: Amber ③ LED flashes at four blinks per second. This condition occurs when the battery voltage of one or more of the Limitless™ switches starts decaying from an acceptable steady state level or is dead. It is recommended that the battery in the Limitless™ switch be replaced as soon as possible. See Section 6.3 (Troubleshooting Mode) for more information in determining the specific Limitless™ switch or switches with a low battery. Also refer to the Limitless™ switch Installation and Technical Manual for proper replacement of the battery.

6.3.1 Insufficient RF Link Indication

WPMM LED Display: Amber ③ LED remains illuminated. This condition occurs when the WPMM stops receiving an RF signal from the Limitless™ switch. An insufficient RF link can be caused by:

- Dead or incorrect battery in Limitless™ switch
- RF range/distance between WPMM and Limitless™ switch is beyond capability
- Exposure to adjacent materials/objects
- Damage or missing antenna from WPMM and/or Limitless™ switch
- Antenna alignment is not acceptable
- Damage to antenna cable

See Section 6.3 (Troubleshooting Mode) for more information in determining the specific switch or switches with an insufficient RF link. Also see Section 11.0 (Troubleshooting Guides).

Figure 9. Limitless™ WPMM LED display



NOTE: Use a blunt object, such as a paper clip or tooth pick to actuate the function switch ④.

6.4 Troubleshooting Mode

Troubleshooting mode can be initiated to determine functional issues with the WPMM and/or Limitless™ switch. Ensure proper power is applied to the WPMM (green LED ② illuminated) before proceeding with this procedure.

Step	Action
1	Completely read this procedure before starting in order to understand the timing of events that need to be performed. Refer to Figure 10.
2	Press the Function button ④ on the WPMM for more than one second and less than four seconds at which time the green ② LED will be flashing which indicates to release the function button ④ immediately as it has entered the Troubleshooting mode.
3	Press the Function button ④ on the WPMM for less than one second at which time the green ② LED will indicate the Limitless™ switch sequence # and if there are any functional issues with this Limitless™ switch. The first Limitless™ switch paired (Sequence #1 switch) will be the first to be indicated as the buzzer will beep once and the green ② LED will blink once and then will pause for one second. The following may be displayed dependent on the first Limitless™ switch status: <ul style="list-style-type: none"> a) Green ② LED illuminated which indicates normal operation with the Limitless™ switch not actuated. b) Red ⑤ output LED will illuminate for four seconds if the Limitless™ switch is actuated and the buzzer will buzz for up to four seconds c) Amber ③ LED flashes at four blinks per second for four seconds indicating Limitless™ switch low battery (Red ⑤ output LED may also be displayed if actuated) d) Amber ③ LED remains illuminated for four seconds indicating insufficient RF link e) Red ⑤ LED flashes and buzzer beeps rapidly the sequence # of the Limitless™ switch that has been purged. (FYI - A purged Limitless™ switch was originally in the system but has since been removed. See Section 6.5 “Purge Mode” for details)
4	Step #3 results can then be reviewed for the rest of the Limitless™ switches (up to 15 more) that have been paired to the WPMM. After the green ② LED starts flashing again, the functional button ④ can be pushed. This will then display the second Limitless™ switch (Sequence #2 switch) per step #3.
5	When the last Limitless™ switch paired to the WPMM, the green ② LED will be flashing and upon actuation of the functional button ④. All LEDs will not illuminate for one second and the WPMM will return to normal operation with the green ② LED illuminated.



ATTENTION

The WPMM will go back to normal operation after 35 seconds if pairing does not occur.

Figure 10. Limitless™ WPMM LED Display



NOTE: Use a blunt object, such as a paper clip or tooth pick to actuate the function switch ④.

6.5 Pairing Mode

Refer to Section 5.4

6.6 Purge Mode

Purge mode is used to remove a Limitless™ switch or switches from the system that have an insufficient RF link with the WPMM (see Section 6.2.1 for possible causes and Section 6.3 for determining which Limitless™ switch(s) have an insufficient RF link). The user will only be allowed to purge one Limitless™ switch with an insufficient RF link at a time and the WPMM will choose the first Limitless™ switch in the Sequence of #1 to #16 that has an insufficient RF link. The user will then need to repeat the purge process if there are more Limitless™ switches to purge (i.e. if the user has ten Limitless™ switches paired to the WPMM and the need is to purge Limitless™ switch sequence #3, 5, and 7; the first sequence # that will be purged is #3, repeating the process will purge #5, etc.)

Note, a Limitless™ switch with a sufficient RF link cannot be purged. If a Limitless™ switch with a good RF link is intended to be purged, remove battery first as this will cause an ‘insufficient RF’ indication after a few minutes. Ensure proper power is applied to the WPMM (green ② LED illuminated) before proceeding with this procedure.

Step	Action
1	Press the Function button ④ on WPMM for approximately eight to 12 seconds at which time the green ②, amber ③, red ⑤ LEDs will be flashing. Refer to Figure 10.
2	The WPMM will then indicate a purge with the red ⑤ LED flashing and the buzzer will beep the sequence number (1 to16) of the Limitless™ switch that is being purged. Once the purge is completed, all LEDs will not illuminate for one second and then the WPMM will return to normal operation with the green ② LED illuminated.
3	Repeat above steps if necessary to purge more Limitless™ switch(s).

6.7 Factory Reset Mode

Factory reset mode is used to remove/un-pair all Limitless™ switches that were previously paired to the WPMM and thus it is being returned to the as-manufactured condition. Ensure proper power is applied to the WPMM (green LED illuminated) before proceeding with this procedure.

Step	Action
1	Press the Function button ④ on WPMM for approximately 16 seconds at which time the green ②, amber ③, red ⑤ LEDs will be flashing and the buzzer will buzz. Continue to hold the Function button on WPMM until the LEDs turn off and the buzzer stops at which time immediately release the Function button. All LEDs will not illuminate for one second and then the WPMM will go through the start-up sequence and then return to normal operation with the green ② LED illuminated. Refer to Figure 10.
2	Verification of proper reset can be confirmed by operating each of the Limitless™ switches that were originally paired to the WPMM that was reset. Repeat procedure if the Limitless™ switches are still indicating an output on the WPMM.
3	Turn power off to WPMM

6.8 Abort Mode

The Abort mode is provided as a last chance for the operator to cancel the operation before the WPMM goes into the Factory Reset mode. If the operator holds the Function button ④ for more than 12 seconds but does not wish to put the WPMM into the Factory Reset mode, the operator can immediately release the function button ④ to put the WPMM into the Abort mode. The WPMM immediately returns to normal operation.

Figure 11. Limitless™ WPMM LED Display



NOTE: Use a blunt object, such as a paper clip or tooth pick to actuate the function switch ④.

7 ANTENNA CONSIDERATIONS/OPTIONS AND MONITOR/ANTENNA INSTALLATION

7.1 Overview of Antenna Options

The following chart lists the antenna options along with the various characteristics that will be referenced throughout this section. This section is intended to assist an end user in determining which antenna(s) are worth investigating and subjecting to application requirements for proof of suitability.

Ant. type code*	Repl. ant.	Replacement antenna mount or cable	Ant. gain (max.)	Design/style	Mount	Cable length	Environment usage **	Antenna material	Cable material/type	Mount material
01	WAN01RSP	N/A	2.2 dBi	Omni/ Straight	Integral	N/A	Indoor or outdoor use	UV stable LG Keyflex BT-1040D	N/A	N/A
02	WAN02RSP	N/A	2.2 dBi	Omni / Tilt and Swivel	Integral	N/A	Indoor or outdoor use	UV stable LG Keyflex BT-1040D	N/A	N/A
03	WAN03RSP	N/A	3.0 dBi	Omni/ Flat	Remote with adhesive mount	2,99 m [9.8 ft]	Indoor or outdoor use	UV stable ABS	UV stable PVC/ RG-174 coax	N/A
04	WAN04RSP	WAMM100R SP-005	5.5 dBi	Omni/ Tilt and Swivel	Remote with magnetic mount	1,52 m [5 ft]	Indoor or limited outdoor exposure. Protect against direct rain, salt, snow, ice, etc.	UV stable Molded Polyurethane	UV stable PVC/ RG-174 coax	UV stable black ABS
05	WAN04RSP	WAMM100R SP-010	5.5 dBi	Omni/ Tilt and Swivel	Remote with magnetic mount	3,04 m [10 ft]	Indoor or limited outdoor exposure. Protect against direct rain, salt, snow, ice, etc.	UV stable Molded Polyurethane	UV stable PVC/ RG-174 coax	UV stable black ABS
06	WAN05RSP	WAMM100R SP-005	9.0 dBi	Omni/ Tilt and Swivel	Remote with magnetic mount	1,52 m [5 ft]	Indoor or limited outdoor exposure. Protect against direct rain, salt, snow, ice, etc.	UV stable Molded Polyurethane	UV stable PVC/ RG-174 coax	UV stable black ABS
07	WAN05RSP	WAMM100R SP-010	9.0 dBi	Omni/ Tilt and Swivel	Remote with magnetic mount	3,04 m [10 ft]	Indoor or limited outdoor exposure. Protect against direct rain, salt, snow, ice, etc.	UV stable Molded Polyurethane	UV stable PVC/ RG-174 coax	UV stable black ABS
08	WAN06RSP	WCA200RNP RSP-002	8.0 dBi	Omni/ Straight	Remote with mast mount	0,91 m [3 ft]	Indoor or outdoor use	UV stable fiberglass	UV stable PVC/RG-316 coax, UV stable Polyethylene/200 Series coax	300 series SST aluminum alloy
09	WAN06RSP	WCA200RNP RSP-010	8.0 dBi	Omni/ Straight	Remote with mast mount	3,35 m [11 ft]	Indoor or outdoor use	UV stable fiberglass	UV stable PVC/RG-316 coax, UV stable Polyethylene/200 Series coax	300 series SST aluminum alloy
10	WAN01RSP	WAMM100R SP-010	2.2 dBi	Omni/ Straight	Remote with magnetic mount	3,04 m [10 ft]	Indoor or limited outdoor exposure. Protect against direct rain, salt, snow, ice, etc.	UV stable LG Keyflex BT-1040D	UV stable PVC/ RG-174 coax	UV stable black ABS

*Reference Limitless™ Nomenclature (i.e. WPMM Series, WGLA Series, etc.)

**Reference Limitless™ Environment Usage section 6.5 for further details



ATTENTION

The antenna cables should not be modified (i.e. cut short and/or re-terminated) as it may affect Communication Agency approval.

WARNING

The WPMM must be installed in accordance with the requirements specified in this document. See Section 3 and Section 4 for EIRP requirements. Only the specified EIRP power settings, antenna types and gains, and cable lengths (attenuation) as outlined in this document are valid for Limitless™ WPMM Series installations.

7.1.1 Omni-directional Antenna Design

The omni-directional antennas offered in the Limitless™ Series were chosen for their ability to be used in applications where transmit-and-receiver antennas may be moving with respect to each other or could also be stationary. They are dipole antennas that radiate power (power from the internal radio of the WPMM monitor) in a 360° outward pattern in a plane perpendicular to the length of the antenna element. “Omni” may suggest the antenna radiates power in all directions, but that is not the case. The actual antenna radiation pattern looks more like a toroid (doughnut-shape) as shown in Figure 12.

Figure 12. Radiation Pattern of an Omni-directional Antenna

Toroid Radiation Pattern -

Pattern is 360 degrees in the vertical plane, but not the horizontal plane

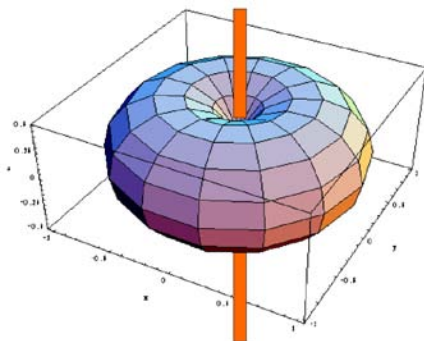

2.2 dBi RF Antenna Pattern -

Horizontal

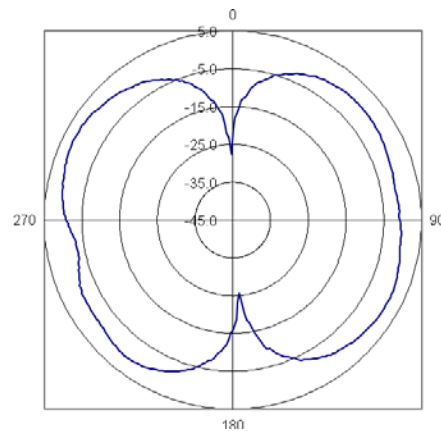

2.2 dBi RF Antenna Pattern -

Vertical

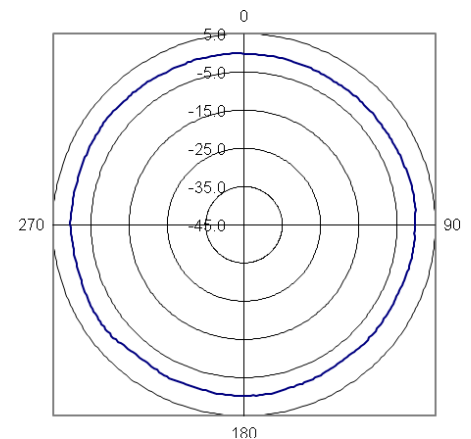

The antenna radiates virtually zero power in the Z axis and most of the power in the X and Y axis. Increasing the antenna’s gain will increase the power only in the X and Y axis. As a result, the radiation pattern becomes more narrow. For instance, this is analogous to the reflector in an automobile’s headlight. The reflector does not add light or increase the luminous intensity of the light bulb, rather it simply directs all the light energy in the forward direction where the light is needed most.

7.2 Antenna Mounting and Considerations

7.2.1 Antenna Mounting Location with Respect to RF Signal

⚠ WARNING
RF EXPOSURE
To satisfy FCC RF exposure requirements for mobile transmitting devices, a separation distance of 20 cm [7.87 in] or more should be maintained between the antenna of this device and persons during device operation. To ensure compliance, operation at closer than this distance is not recommended. The antenna used for this transmission must not be co-located in conjunction with any other antenna or transmitter.
Failure to comply with these instructions could result in death or serious injury.

There are several environmental factors to consider with respect to antenna location during installation. These factors can affect the radio frequency (RF) signal strength being both transmitted and received by the Limitless™ switch and corresponding WPMM monitor. It is desirable for the antenna to be mounted to limit exposure of adjacent materials/objects between the Limitless™ switch and WPMM monitor, as they will have an effect on RF signal strength. If the mounting location for an omni-directional antenna is on the side of a building or tower, the antenna pattern will be degraded on the building or tower side.

Obstacles that affect antenna patterns and RF signal strength:

- Indoor: Concrete, wood, drywall, and metal walls, etc.
- Outdoor: Vehicles, buildings, trees, structures, topology, weather conditions, chain link fence, major power cables, etc.

Best performance is achieved when antennas for both the Limitless™ switch and WPMM monitor are mounted at the same height and in a direct line of sight (LOS) with no obstructions. Generally, the higher the antenna is above ground, the better it performs. Another concern is RF interference, discussed in Section 1.5.3.

Figure 13. Limitless™ switch to WPMM Antennas with RF Signal Line of Sight (LOS) Free From Obstacles

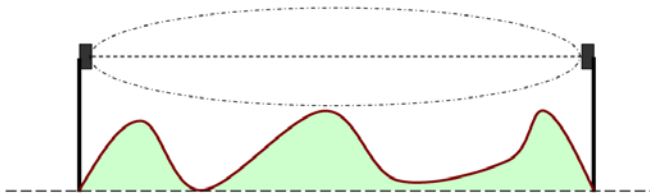
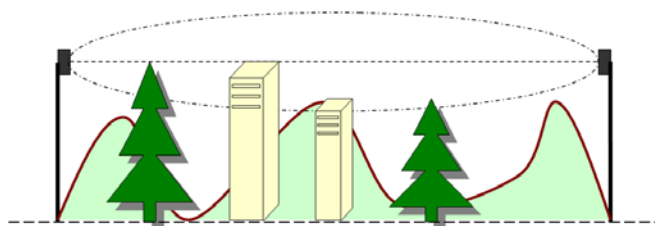

Figure 14. Limitless™ switch to WPMM Antennas with RF Signal Line of Sight (LOS) Affected by Obstacles



7.2.2 Outdoor Installation Warnings

 **WARNING****LIVES MAY BE AT RISK!**

Carefully observe these instructions and any special instructions included with the equipment being installed.

 **WARNING****CONTACTING POWER LINES CAN BE LETHAL**

Look over the site before beginning any installation and anticipate possible hazards, especially these:

- Make sure no power lines are near where possible contact can be made. Antennas, masts, towers, guy wires, or cables may lean or fall and contact these lines. People may be injured or killed if they are touching or holding any part of equipment when it contacts electric lines. Make sure there is NO possibility that equipment or personnel can come in contact directly or indirectly with power lines.
- Assume all overhead lines are power lines.
- The horizontal distance from a tower, mast, or antenna to the nearest power line should be at least twice the total length of the mast/antenna combination. This will ensure that the mast will not contact power if it falls during either installation or later.

 **WARNING****TO AVOID FALLING, USE SAFE PROCEDURES WHEN WORKING AT HEIGHTS ABOVE GROUND**

- Select equipment locations that will allow safe, simple equipment installation
- Don't work alone. A friend or co-worker can save a life if an accident happens.
- Use approved, non-conducting ladders and other safety equipment. Make sure all equipment is in good repair.
- If a tower or mast begins falling, don't attempt to catch it. Stand back and let it fall.
- If anything such as a wire or mast does come in contact with a power line, DON'T TOUCH IT OR ATTEMPT TO MOVE IT. Instead, save a life by calling the power company.
- Don't attempt to erect antennas or towers on windy days.

 **WARNING****MAKE SURE ALL TOWERS AND MASTS ARE SECURELY GROUNDED, AND ELECTRICAL CABLES CONNECTED TO ANTENNAS HAVE LIGHTNING ARRESTORS.**

This will help prevent fire damage or human injury in case of lightning, static build up, or short circuit within equipment connected to antenna.

- The base of the antenna mast or tower must be connected directly to the building protective ground or to one-or-more approved grounding rods, using 1 AWG ground wire and corrosion-resistant connectors.
- Refer to the National Electrical Code for grounding details.
- Lightning arrestors for antenna feed coaxial cables are available from HyperLink Technologies, Inc.

 **WARNING**

If a person comes in contact with electrical power, and cannot move

DO NOT TOUCH THAT PERSON OR RISK ELECTROCUTION

- Use a non-conductive dry board, stick, or rope to push, pull, or drag them so they no longer are in contact with electrical power.
- Once they are no longer contacting electrical power, administer CPR if certified, and make sure emergency medical aid has been requested.

7.2.3 Antenna Connection, Styles, and Mounting Options

⚠ WARNING
RF EXPOSURE
 To satisfy FCC RF exposure requirements for mobile transmitting devices, a separation distance of 20 cm [7.87 in] or more should be maintained between the antenna of this device and persons during device operation. To ensure compliance, operation at closer than this distance is not recommended. The antenna used for this transmission must not be co-located in conjunction with any other antenna or transmitter.
Failure to comply with these instructions could result in death or serious injury.

CAUTION
 Power to the WPMM monitor should not be applied during installation of an antenna as damage could occur to the WPMM monitor electronics.

7.2.3.1 Antenna Connection

Physical connection of the antenna to the WPMM monitor is accomplished by using mating RP-SMA connectors: plug and jack. Integral-mount antennas have an RP-SMA plug that connects directly to the WPMM RP-SMA jack. The remote mount antenna uses a cable with a RP-SMA plug that connects directly to the WPMM RP-SMA jack allowing the antenna to be remotely mounted away from the WPMM monitor. Mounting options are based on user preference, communication agency approvals, WPMM monitor mounting location, and obstacles as discussed in Section 6.2.1.

An **integral or remote mount antenna** can be easily mounted by threading the mating RP-SMA plug of the antenna to the RP-SMA jack on the WPMM monitor. Reference section 7.5 for further details on extra environmental protection of RP-SMA connections. Tighten the RP-SMA connection until finger tight, and then attach the lime/black guard finger tight. See Figures 15 and 16.

Figure 15. Limitless™ WPMM RP-SMA Connection, Integral



Figure 16. Limitless™ WPMM RP-SMA Connection, Remote

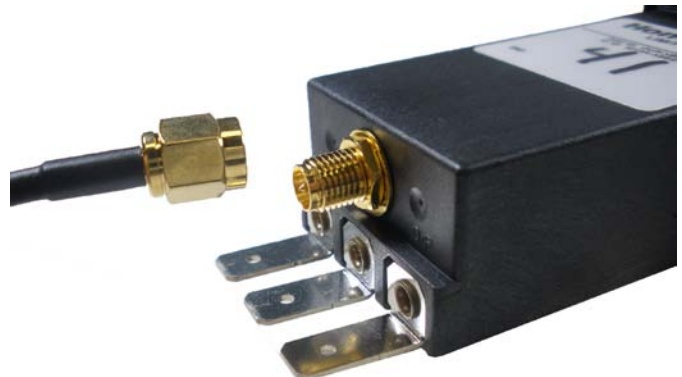

7.2.3.2 Antenna Styles and Mounting Options

Choosing an antenna mounting style depends on application conditions, along with antenna benefits and/or features and user preference. The antenna’s gain (discussed further in Section 7.4) to some extent determines physical size; also a consideration is the amount of room available in the application.

Straight or Tilt/Swivel: A benefit of the straight antenna is its rigid design and resistance to being repositioned (shock, vibration, wind, etc.) when compared to a tilt and swivel design. It is also more resistant to weather conditions as there’s no swivel-joint connection for contaminants to enter. A benefit of the tilt & swivel design is that it allows easier positioning in relation to other antenna(s) to obtain a suitable RF signal.

Figure 17. Straight and Tilt/Swivel antennas



Adhesive mount: The benefit of the remote adhesive mount antenna is mounting flexibility to a number of surfaces and in various orientations. Remember, the surface that the antenna is being mounted to will affect the radiation pattern so it is suggested that masking tape be used to temporarily attach the antenna. Perform fade-margin testing, as described in Section 6.4 before permanently mounting.

Permanent mounting: Pre-clean the surface where the antenna is to be mounted with an alcohol wipe. Peel paper protection from adhesive strip and mount to the cleaned surface.

Figure 18. Adhesive Mount Antenna – Step 1. Pre-clean the surface



Figure 19. Adhesive Mount Antenna – Step 2. Peel Protection from Adhesive Strip



Figure 20. Adhesive Mount Antenna – Step 3. Mount the Antenna



Mast mount: The benefit of the mast-mount antenna is its rigid design and resistance to displacement when subjected to shock, vibration, wind, etc. It can be easily mounted high above the ground to obtain greater RF signal performance and it withstands winds up to 100 mph.

- **Mast-mount bracket** (Included with the 8 dBi antenna): Attach antenna to its mounting bracket and tighten nut. Assemble two U-clamps around mast and tighten nuts to ensure lock washers provided are compressed to a flat condition.

Figure 21. Mast Mount Antenna – Tighten nut on mounting bracket



Figure 22. Mast Mount Antenna – Side View with Attachment to Pipe



Magnetic mount: The benefit of the magnetic-mount antenna is its ability to mount on any ferrous-metal surface and in various orientations. A smooth metal surface is preferred to allow the best attraction of the magnet to the surface. First, the user will need to determine if the magnetic attraction is sufficient to hold the antenna in the desired position (i.e., shock, vibration, etc. in the application). Placing the antenna in a location where it cannot be inadvertently displaced may help. Magnetic-mount antennas are not designed for mobile applications.

7.2.4 Antenna Adjustment Considerations

The antenna of the Limitless™ switch and WPMM monitor should be oriented in parallel. This will, in most cases, allow the longest range and highest RF signal. The least RF signal is normally in a direction in-line with the top of the antenna, so avoid having antennas pointed directly toward or directly away from each other.

Figure 23. Magnetic Mount Bracket with Antenna – Mounted on Steel Surface

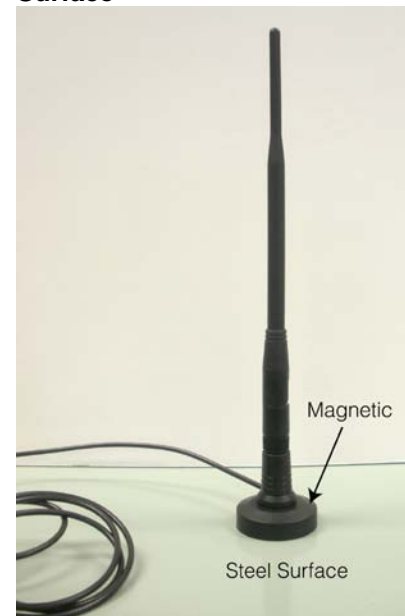
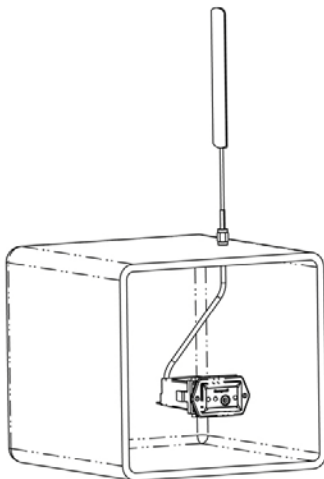

Figure 24. Highest RF signal when antennas are as parallel to each other as possible



7.3 Estimating Range of an Antenna

The signal range is defined as the physical distance between the Limitless™ switch and WPMM monitor. It's a function of the antenna's gain, radio output of the Limitless™ switch and WPMM monitor (8 dBm or 18 dBm), and cable loss (if used) in conjunction with the environment (i.e. outdoor urban, indoors, etc.) that the Limitless™ product is operating in. The Honeywell antenna range calculator can be used to estimate the expected signal range that can be achieved between the Limitless™ switch and WPMM monitor with chosen antennas, cable extensions, radio output, etc. The calculator can be found at www.honeywell.com/limitless.

Signal range specification:

250 m [820 ft] (nominal) – 8 dBm radio output

305 m [1000 ft] (nominal) – 18 dBm radio output

Line of sight with a 2.2 dBi antenna installed on the Limitless™ switch and WPMM monitor

7.4 Choosing an Antenna Gain (dBi) with Acceptable Fade-Margin

There are several different antenna gain options in the Limitless™ Series to choose from. This section helps determine the antenna version(s) that will provide suitable RF signal performance for specific applications.

The Limitless™ Series antenna's actual gain is measured by how much of the input power from the internal radio of the WPMM monitor is concentrated in a particular direction. The WPMM monitor's antenna transmits RF signals, and also receives RF signals from a Limitless™ switch. In a particular application, transmit signal strength may be better than the receive signal strength or vice versa. The intent is to choose an antenna with the optimum gain relative to application conditions for both transmitting and receiving.

Fade-margin is the amount of excess power available above and beyond what is necessary to maintain a reliable RF signal between the transmitter and receiver. Normally, an acceptable threshold of excess power to ensure effective operation in a variety of environmental conditions is 10 dB. A simple way to determine if the signal strength is sufficient is to temporarily install a 10 dB attenuator* between the RP-SMA plug of the antenna or remote cable and RP-SMA jack of the WPMM monitor. This should be completed in an operating application environment with good nominal environmental conditions. Starting with the antenna chosen in Section 8.2, install the attenuator and operate the system until exposure of all normal application conditions is completed while monitoring the amber LED (RF link/signal indicator of the WPMM monitor). If the fade-margin is unacceptable, the LED turns on solid indicating that the antenna position on the Limitless™ switch and/or WPMM monitor will need to be changed or another antenna type should be chosen.

Try several mounting locations and/or antennas while retesting each with the attenuator to determine the optimal set-up that provides an acceptable fade-margin. Remember to remove the attenuator after testing is completed.

*Suggested sources/part numbers

- 10 dB attenuator (i.e. Crystek – Part number: CATTEN-0100)
- RP-SMA female to SMA male connector adaptor (i.e. Connector City – Part number : ADP-SMAM-RPSF)
- RP-SMA male to SMA female connector adaptor (i.e. Connector City – Part number : ADP-RPSM-SMAF)

7.5 Environmental Usage/Concerns

7.5.1 Choosing an Antenna/Cable to Meet Application Exposure Conditions

There is no antenna or cable design impervious to every environmental condition that it could be exposed to. So it is suggested that the application environment be reviewed as follows:

Step 1	Determine where the antenna will be installed and the application conditions: indoor, outdoor, or limited outdoor exposure. Even if the antenna is going to be used indoors, an outdoor antenna may be more suitable (i.e., resistant to fluids, rigid construction, etc.)
Step 2	Determine what the antenna may be subjected to (i.e., fluids, chemicals, oils, wind, shock, vibration, etc.)
Step 3	<p>A. Review antenna and/or cable materials (listed in Section 6.1) against resistance to chemicals and fluids. If choosing an adhesive mount, adhesive resistance testing may be necessary.</p> <p>B. If shock, vibration, wind, rain, sleet/snow, etc. are in the application, choose an antenna rated for outdoors and has a rigid design as defined in Sections 6.1 and 6.2.3.2.</p>
Step 4	<p>The WPMM’s enclosure is designed to meet IP67 seal requirements. The electrical connections for the power supply and NPN output are not protected against exposure to liquids. This step may be required to provide an extra level of protection, especially if the application may be subjecting antennas and cables to liquids. The RP-SMA connections, tilt/swivel joints, and cable entrances are potential leak paths that could lead to corrosion. The following procedure is one way to provide extra protection to these connections and joints.</p> <p>Ensure that the area applying tape to is clean from contaminants by first cleaning with mild detergent/water and completely dry. Follow with an isopropyl alcohol wipe of the area.</p> <p>Layer 1: Wrap a layer of polyvinyl chloride insulating tape Layer 2: Wrap a layer of Rubber splicing tape i.e. Scotch™ 23 Layer 3: Wrap a layer of UV stable polyvinyl chloride insulating tape</p> <p>Layer 1 allows the user to remove Layer 2 for connector inspection, antenna replacement, repositioning of the tilt/swivel antenna, etc.</p>

In the end, the antenna/cable choice may need to be tested in the actual application conditions to prove suitability.

7.5.2 Outdoor Antenna Installations - Lightning Concerns

Outdoor antenna installations can lead to the possible damage caused by nearby lightning strikes that induce charges or surges on the antenna and/or antenna extension cables.

A lightning arrestor such as the AL-NFNFB-9 from Hyperlink Technologies can be reviewed against application requirements.



ATTENTION

National, local and/or regulatory agencies may require the use of a lightning arrestor and possibly other requirements for an antenna system installation. It is recommended that the customer review and adhere to these requirements.

7.5.3 RF Interference

The WGLA switch and WPMM radio operate in the 2.4 GHz range. Upon initial pairing with the WGLA switch, the WPMM's radio will automatically scan each of the 16 channels in the 2.4 GHz range and choose a channel with the least amount of usage. This provides a level of protection from RF interference as the chosen channel where RF communication is low will have a lower chance of signal collision.

However, if multiple RF sources exist in the chosen channel or the external source has an extremely high power intensity or it is in close proximity to the Limitless™ Series antenna, RF interference can cause an RF signal to not reach the WGLA switch or WPMM monitor. RF interference can be caused by many sources (i.e., other radios in the same operating range, solar activity, high frequency digital products, conventional microwave ovens, etc.). If the Limitless™ Series is in an environment with a high usage of products in the 2.4 GHz range, or the RF environment is unknown, an on-site RF survey may prove to be valuable in identifying possible RF interference sources along with other existing wireless devices.

Once the RF sources are identified and located, it may allow the Limitless™ Series antennas to be moved away from the identified RF sources to achieve acceptable performance. The other option is removing the external source, if feasible.

7.6 Panel Mounting

The WPMM is intended to be inserted into a 0.95 in x 1.45 in [24,13 mm x 36,83 mm] panel cut-out. Installation should have the correct cut-out or a panel-mount bracket may be used. Honeywell part number WPB1 is an alternative (See Section 9.3).

Insert the housing into the panel or panel-mount bracket so that the bezel is firmly seated against the panel surface as shown in Figure 24. The retainer clip (supplied with unit) will then need to slide over the back of the housing and lock against the underside of the panel as shown in Figure 25. The other mounting alternative is to use the two mounting holes located in the front bezel (see Figure 26) and attach with #6-32 (not supplied). Also reference Section 9.3.

Figure 25. WPMM Panel Mount – Back View



Figure 26. WPMM Panel Mount – Back View In Place



Figure 27. WPMM Panel Mount – Front View



8 INSPECTION AND MAINTENANCE

8.1 WPMM Inspection and Replacement

Periodic inspection

- Check the WPMM housing for signs of damage. Replace if necessary

8.2 Antenna Inspection and Replacement

Periodic inspection

- Check antenna or cable connection to WPMM connector to ensure it is tight and no signs of damage or corrosion. Replace if necessary per Section 7.2.





9 ACCESSORIES

9.1 Antenna Options

WAN	01	RSP	— — —																
Antenna type	Antenna type code	Connector Code	Specials																
WAN Series Antenna	<table border="1"> <tr> <td>01</td> <td>2.2 dBi omni; straight design</td> </tr> <tr> <td>02</td> <td>2.2 dBi omni; tilt & swivel des.</td> </tr> <tr> <td>03</td> <td>3.0 dBi omni with adhesive mount & 9.8 ft cable</td> </tr> <tr> <td>04</td> <td>5.5 dBi omni;*** tilt & swivel des.</td> </tr> <tr> <td>05</td> <td>9.0 dBi omni;*** tilt & swivel des.</td> </tr> <tr> <td>06</td> <td>8.0 dBi omni w/ bracket, straight des, 1 ft cable</td> </tr> </table>	01	2.2 dBi omni; straight design	02	2.2 dBi omni; tilt & swivel des.	03	3.0 dBi omni with adhesive mount & 9.8 ft cable	04	5.5 dBi omni;*** tilt & swivel des.	05	9.0 dBi omni;*** tilt & swivel des.	06	8.0 dBi omni w/ bracket, straight des, 1 ft cable	<table border="1"> <tr> <td>RNJ</td> <td>Reverse polarity N jack**</td> </tr> <tr> <td>RSP</td> <td>Reverse polarity SMA plug</td> </tr> </table>	RNJ	Reverse polarity N jack**	RSP	Reverse polarity SMA plug	Use only if antenna has a special feature.
01	2.2 dBi omni; straight design																		
02	2.2 dBi omni; tilt & swivel des.																		
03	3.0 dBi omni with adhesive mount & 9.8 ft cable																		
04	5.5 dBi omni;*** tilt & swivel des.																		
05	9.0 dBi omni;*** tilt & swivel des.																		
06	8.0 dBi omni w/ bracket, straight des, 1 ft cable																		
RNJ	Reverse polarity N jack**																		
RSP	Reverse polarity SMA plug																		

** Only used with 06 antenna type code
 *** Limited outdoor exposure. Protect against direct rain, salt, snow, ice, etc.

Limitless™ Antennas

WAN01RSP Straight Design Direct Mount Connector	WAN02RSP Tilt and Swivel Design, Direct Mount Antenna	WAN05RSP with WAMM100RSP-005 Tilt and Swivel Design, Magnetic Mount Antenna	WAN03RSP Flat Design, Adhesive Mount Antenna	WAN06RNJ Straight Design, Bracket Mount Antenna
				

9.2 Antenna Cable Options

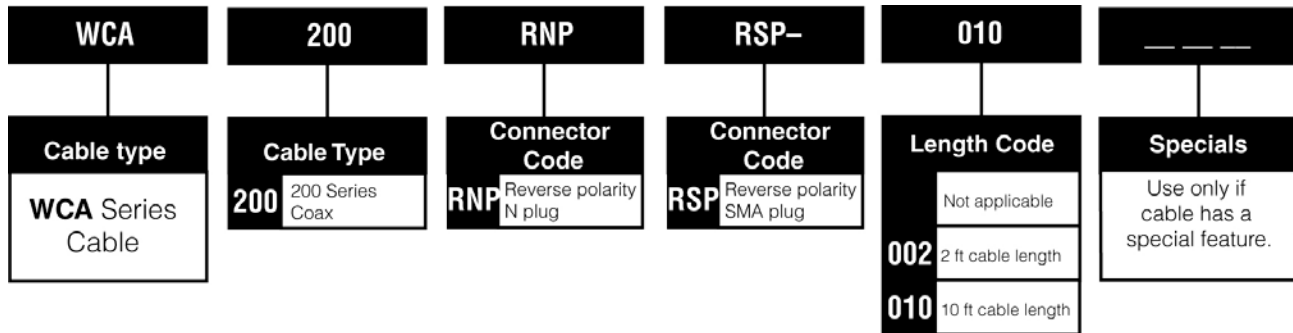

Limitless™ Cable Accessories

WCA200RNPRSP-002/010 Cable Assembly



9.3 Mounting Options

WAM	M	100	RSP-	005	— — —
Mounting WAM Series Antenna Mount	Type Code M Magnetic	Cable Type 100 100 Series Coax	Connector Code RSP Reverse polarity SMA plug	Length Code 005 5 ft cable length 010 10 ft cable length	Specials Use only if mount has a special feature.
WPR	1		WPB	1	
Mounting WPR Series Panel Mount Retainer	Type Code 1 Snap-in mounting clip		Mounting WPB Series WPMM Mounting Bracket	Type Code 1 Mounting bracket	

WAMM100RSP-005/010 Magnetic Antenna Mount



WPR1 Panel Mount Retainer



WPB1 WPMM Mounting Bracket



10 INSTALLATION DRAWINGS

10.1 Drawing Availability

Complete installation drawings for each listing of the WPMM Series and Limitless™ accessories are available at www.honeywell.com/sensing

11 TROUBLESHOOTING GUIDES

The troubleshooting guide includes WPMM indications and symptoms as it is being used in conjunction with the Limitless™ switch series.

SYMPTOM	CAUSE	RESOLUTION
Green LED is not ON	10 Vdc to 30 Vdc is not applied to "+" & "-" terminals	Check for proper connection and 10 Vdc to 30 Vdc to "+" and "-" terminals
	Power leads connected in reverse	Check for proper connection of power: "+" and "-" terminals
Green, amber and/or red LEDs do not blink ON at start-up	WPMM internal electronics damaged	Replace WPMM
	LED(s) burnt out	Replace WPMM
Green, amber, and red LEDs are momentarily OFF then ON with possible NPN output change during normal operation. Resulting in only green LED on and possibly incorrect amber and red LED indication/output for up to 30 seconds.	ESD/EMI exposure beyond published specifications or device performing self check	Determine source for ESD/EMI emissions in application and take action to remove
Amber LED is flashing	Low battery in Limitless™ switch	<ul style="list-style-type: none"> Determine which Limitless™ switch has a low battery using the procedure in Section 6.3 Replace Limitless™ switch battery per Limitless™ switch Installation guide
	Incorrect battery installed in Limitless™ switch	<ul style="list-style-type: none"> Determine which Limitless™ switch has a low battery using the procedure in Section 6.3 Replace Limitless™ switch battery per Limitless™ switch Installation guide
Amber LED is constantly ON	Dead or Low battery in Limitless™ switch	<ul style="list-style-type: none"> Determine which Limitless™ switch has a low battery using the procedure in Section 6.3 Limitless™ switch status will in this case be reported as insufficient RF Replace Limitless™ switch battery per Limitless™ switch installation guide
	Incorrect battery installed in Limitless™ switch	<ul style="list-style-type: none"> Determine which Limitless™ switch has a low battery using the procedure in Section 6.3 Limitless™ switch status will in this case be reported as insufficient RF Replace Limitless™ switch battery per Limitless™ switch installation guide
	RF range/distance between WPMM and Limitless™ switch is beyond capability	Reposition Limitless™ switch closer to the WPMM until amber LED is no longer ON
	Exposure to adjacent materials/objects and/or materials/objects	Reposition Limitless™ switch away from objects until amber LED is no longer ON
	Damage or missing antenna from WPMM and/or Limitless™ switch	Replace antenna per Section 7.3
	Antenna alignment is not acceptable	Reposition antenna per Section 7.3
	Damage to antenna cable	Replace antenna cable per Section 7.3
	Loose antenna or cable connections	Check connections and tighten as necessary per Section 7.3

SYMPTOM	CAUSE	RESOLUTION
Red LED is not ON and buzzer does not sound when Limitless™ switch is actuated (green LED ON, amber LED OFF)	Limitless™ switch is not paired to WPMM	Pair Limitless™ switch to WPMM per Section 5.4
	External actuator of Limitless™ switch damaged	Replace Limitless™ actuator
	Actuating head of Limitless™ switch damaged	Replace Limitless™ actuating head
	Limitless™ switch internal electronics damaged	Replace Limitless™ switch
	Amber LED burnt out or damaged electronics of WPMM	Replace WPMM
	Red LED burnt out	Replace WPMM
Buzzer not sounding when Limitless™ switch is actuated (green LED ON, amber LED OFF)	Limitless™ switch is not paired to WPMM	Pair Limitless™ switch to WPMM per Section 5.4
	External actuator of Limitless™ switch damaged	Replace Limitless™ actuator
	Actuating head of Limitless™ switch damaged	Replace Limitless™ actuating head
	Limitless™ switch internal electronics damaged	Replace Limitless™ switch
	Amber LED burnt out or damaged electronics of WPMM	Replace WPMM
	Buzzer burnt out	Replace WPMM
NPN output is not changing state when Limitless™ switch is actuated (green LED ON, amber LED OFF)	Limitless™ switch is not paired to WPMM	Pair Limitless™ switch to WPMM per Section 5.4
	Incorrect connections	Check for correct connections to output terminal "O" with respect to minus "-" terminal
	External actuator of Limitless™ switch damaged	Replace Limitless™ actuator
	Actuating head of Limitless™ switch damaged	Replace Limitless™ actuating head
	Limitless™ switch internal electronics damaged	Replace Limitless™ switch
	Damaged output	Replace WPMM

WARRANTY/REMEDY

Honeywell warrants goods of its manufacture as being free of defective materials and faulty workmanship. Honeywell's standard product warranty applies unless agreed to otherwise by Honeywell in writing; please refer to your order acknowledgement or consult your local sales office for specific warranty details. If warranted goods are returned to Honeywell during the period of coverage, Honeywell will repair or replace, at its option, without charge those items it finds defective. **The foregoing is buyer's sole remedy and is in lieu of all other warranties, expressed or implied, including those of merchantability and fitness for a particular purpose. In no event shall Honeywell be liable for consequential, special, or indirect damages.**

While we provide application assistance personally, through our literature and the Honeywell web site, it is up to the customer to determine the suitability of the product in the application.

Specifications may change without notice. The information we supply is believed to be accurate and reliable as of this printing. However, we assume no responsibility for its use.

SALES AND SERVICE

Honeywell serves its customers through a worldwide network of sales offices, representatives and distributors. For application assistance, current specifications, pricing or name of the nearest Authorized Distributor, contact your local sales office or:

E-mail: info.sc@honeywell.com

Internet: www.honeywell.com/sensing

Phone and Fax:

Asia Pacific	+65 6355-2828
	+65 6445-3033 Fax
Europe	+44 (0) 1698 481481
	+44 (0) 1698 481676 Fax
Latin America	+1-305-805-8188
	+1-305-883-8257 Fax
USA/Canada	+1-800-537-6945
	+1-815-235-6847
	+1-815-235-6545 Fax

Sensing and Control
Honeywell
1985 Douglas Drive North
Golden Valley, MN 55422
www.honeywell.com

50081864-2-EN IL50 GLO Printed in USA
June 2010
Copyright © 2010 Honeywell International Inc. All rights reserved.

Honeywell