

ASSEMBLY NUMBER	FINISH
73656-0000	SEE NOTE 2.
73656-0001	SEE NOTE 3.

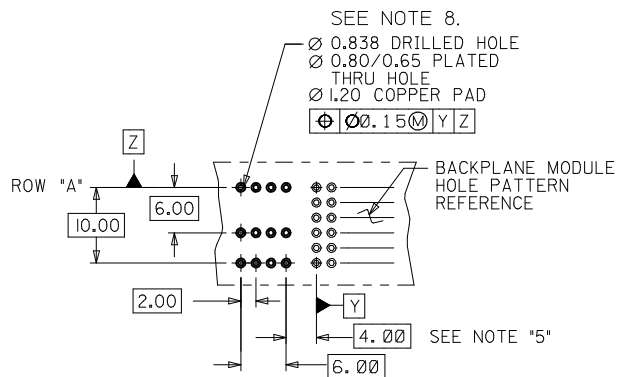
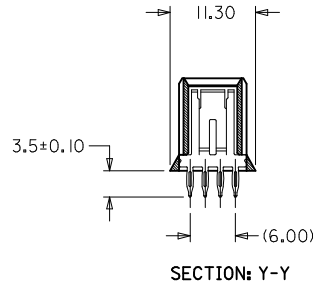
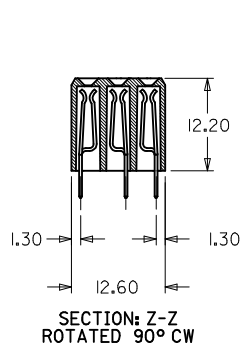
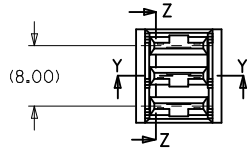
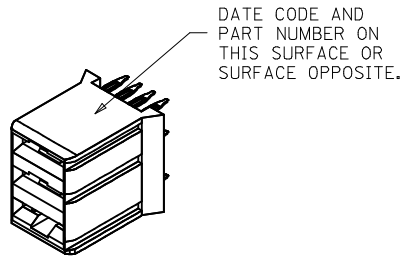

PCB LAYOUT: COMPONENT SIDE
RECOMMENDED PCB THICKNESS: 2.50 MIN

NOTES:

1. MATERIALS: HOUSING - LIQUID CRYSTAL POLYMER (LCP), GLASS-FILLED, UL94V-0, COLOR: BLACK
TERMINAL - COPPER ALLOY
2. FINISH: SELECTIVE GOLD (Au) IN CONTACT AREA, 0.76 micrometer MINIMUM THICKNESS: NICKEL (Ni) AND GOLD FLASH OVERALL
3. FINISH: SELECTIVE GOLD (Au) IN CONTACT AREA, 0.76 micrometer MINIMUM THICKNESS: TIN/LEAD (Sn/Pb) OVER NICKEL (Ni) IN COMPLIANT AREA: NICKEL (Ni) OVERALL ON REMAINING WITH SELECTIVE GOLD (Au) FLASH.
4. THIS DIMENSION MUST BE A MULTIPLE OF 4.00 mm.
5. DIMENSIONS ARE IN MILLIMETERS.
6. THIS PART CONFORMS TO MOLEX PRODUCT SPECIFICATION PS-73670-9999.
7. PACKAGE ASSEMBLIES PER PK-70873-0819.
8. HOLE SIZE SPECIFICATION IS FOR TIN/LEAD PLATED HOLES ONLY. FOR OTHER PLATING TYPES SEE MOLEX APPLICATION AS-73670-9996.
9. THIS PART CONFORMS TO MOLEX COSMETIC SPECIFICATION PS-45499-002 CLASS B.

ADD NOTES 8 & 9 EC NO: UCP2009-1813 DRWNS:DANNELLEY 2009/07/17 CHKD:BSMART 2009/07/24 APPR:SMILLER 2009/07/24	QUALITY SYMBOLS ▽=0 ▽=0	GENERAL TOLERANCES (UNLESS SPECIFIED) <table border="1"> <tr> <th></th> <th>mm</th> <th>INCH</th> </tr> <tr> <td>4 PLACES</td> <td>± .005</td> <td>± .0004</td> </tr> <tr> <td>3 PLACES</td> <td>± .008</td> <td>± .0006</td> </tr> <tr> <td>2 PLACES</td> <td>± .015</td> <td>± .0012</td> </tr> <tr> <td>1 PLACE</td> <td>± .030</td> <td>± .0024</td> </tr> </table>		mm	INCH	4 PLACES	± .005	± .0004	3 PLACES	± .008	± .0006	2 PLACES	± .015	± .0012	1 PLACE	± .030	± .0024	DIMENSION STYLE MM ONLY DRAWN BY DATE ELO 1998/05/21 CHECKED BY DATE SMR 1998/05/21 APPROVED BY DATE CAB 1998/05/21	SCALE 1:1 DESIGN UNITS METRIC THIRD ANGLE PROJECTION	TITLE SALES ASSY , HDM BACKPLANE POWER MODULE (PRESSFIT) MOLEX MOLEX INCORPORATED MATERIAL NO. SEE TABLE DOCUMENT NO. SDA-73656-*00*	SHEET NO. 1 OF 4
		mm	INCH																		
	4 PLACES	± .005	± .0004																		
	3 PLACES	± .008	± .0006																		
2 PLACES	± .015	± .0012																			
1 PLACE	± .030	± .0024																			
DRAFT WHERE APPLICABLE MUST REMAIN WITHIN DIMENSIONS	SIZE C	THIS DRAWING CONTAINS INFORMATION THAT IS PROPRIETARY TO MOLEX INCORPORATED AND SHOULD NOT BE USED WITHOUT WRITTEN PERMISSION																			

DATE CODE AND
PART NUMBER ON
THIS SURFACE OR
SURFACE OPPOSITE.

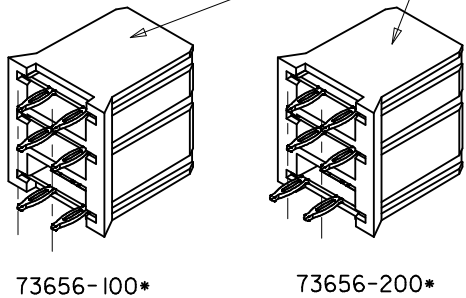

MIDPLANE OPTION

ASSEMBLY NUMBER	FINISH (SEE SHT 1)
73656-1000	SEE NOTE 2. (GOLD TAILS)
73656-2000	
73656-1001	SEE NOTE 3. (TIN/LEAD TAILS)
73656-2001	

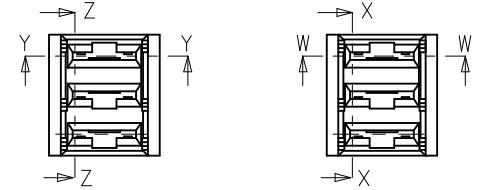

USE BACKPLANE MODULE
HOLE REFERENCE PATTERN
FROM SHEET 1

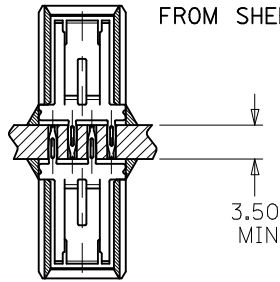

BACK-TO-BACK
MOUNTING APPLICATION

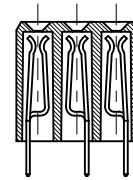
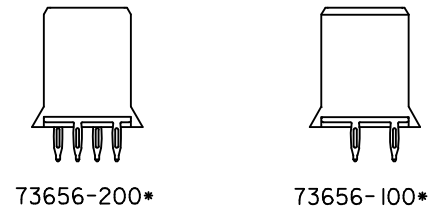

SECTION X-X
SECTION Z-Z
ROTATED 90° CW

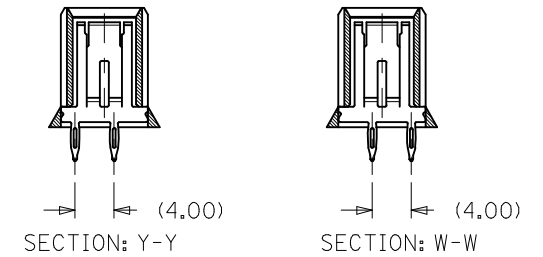

SEE SHEET 1 EC NO: UCP2009-1813 DRWN: SDANNELLEY 2009/07/17 CHKD: BSMART 2009/07/24 APPR: SMILLER 2009/07/24	DESCRIPTION REV	QUALITY SYMBOLS ▽=0 ▽=0	GENERAL TOLERANCES (UNLESS SPECIFIED)		DIMENSION STYLE MM ONLY		SCALE 1:1	DESIGN UNITS METRIC	THIRD ANGLE PROJECTION		
		4 PLACES ± --- ± --- 3 PLACES ± --- ± --- 2 PLACES ± --- ± --- 1 PLACE ± --- ± ---	mm INCH	DRAWN BY ELO	DATE 1998/05/21	TITLE SALES ASSY, HDM BACKPLANE POWER MODULE (PRESSFIT)					
		ANGULAR ±1/2°		CHECKED BY SMR	DATE 1998/05/21	MOLEX INCORPORATED					
		DRAFT WHERE APPLICABLE MUST REMAIN WITHIN DIMENSIONS		APPROVED BY CAB	DATE 1998/05/21	MATERIAL NO. SEE TABLE	DOCUMENT NO. SDA-73656-*00*	SHEET NO. 2 OF 4			

10	9	8	7	6	5	4	3	2	
ASSEMBLY NUMBER		FINISH (SHT I)							
73656-5000		SEE NOTE 2.							
73656-5001		SEE NOTE 3.							

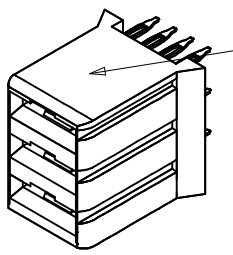

DATE CODE AND PART NUMBER ON THIS SURFACE OR SURFACE OPPOSITE.

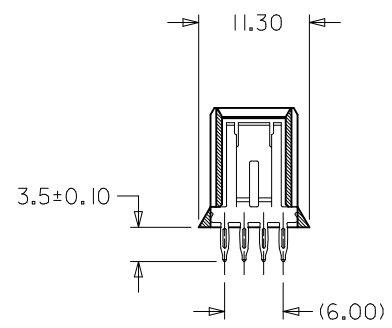
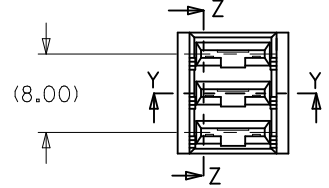

SECTION: Y-Y

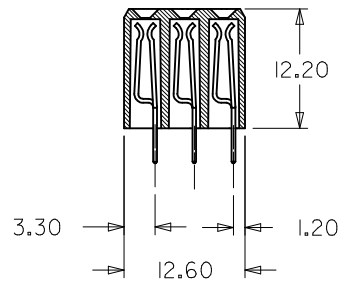

SECTION: Z-Z ROTATED 90° CW

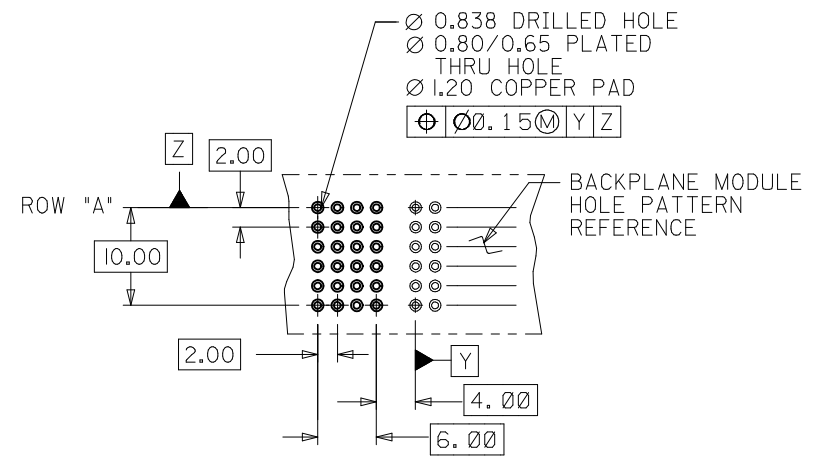
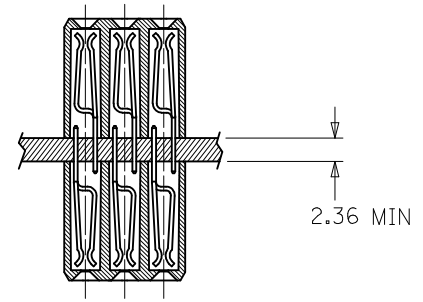

SEE SHEET 1 EC NO: UCP2009-1813 DRWN:SDANNELLEY 2009/07/17 CHKD:BSMART 2009/07/24 APPR:SMILLER 2009/07/24	DESCRIPTION REV	QUALITY SYMBOLS ▽=0 ▽=0	GENERAL TOLERANCES (UNLESS SPECIFIED) mm INCH 4 PLACES ± --- ± --- 3 PLACES ± --- ± --- 2 PLACES ± --- ± --- 1 PLACE ± --- ± --- ANGULAR ±1/2°	DIMENSION STYLE MM ONLY DRAWN BY DATE ELO 1998/05/21 CHECKED BY DATE SMR 1998/05/21 APPROVED BY DATE CAB 1998/05/21	SCALE 1:1 DESIGN UNITS METRIC THIRD ANGLE PROJECTION	TITLE SALES ASSY, HDM BACKPLANE POWER MODULE (PRESSFIT)
		DRAFT WHERE APPLICABLE MUST REMAIN WITHIN DIMENSIONS	MATERIAL NO. SEE TABLE	DOCUMENT NO. SDA-73656-*00*	SHEET NO. 3 OF 4	
		THIS DRAWING CONTAINS INFORMATION THAT IS PROPRIETARY TO MOLEX INCORPORATED AND SHOULD NOT BE USED WITHOUT WRITTEN PERMISSION				
		MOLEX INCORPORATED				

ASSEMBLY NUMBER	FINISH
73656-0180	SEE NOTE 2.
73656-0181	SEE NOTE 3.

DATE CODE AND PART NUMBER ON THIS SURFACE OR SURFACE OPPOSITE.

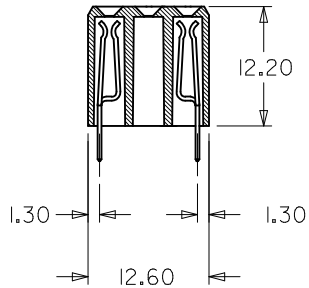
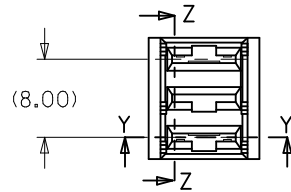
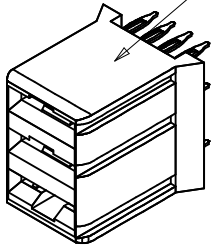

SECTION: Z-Z
ROTATED 90° CW

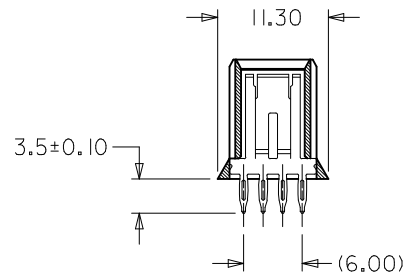

SECTION: Y-Y

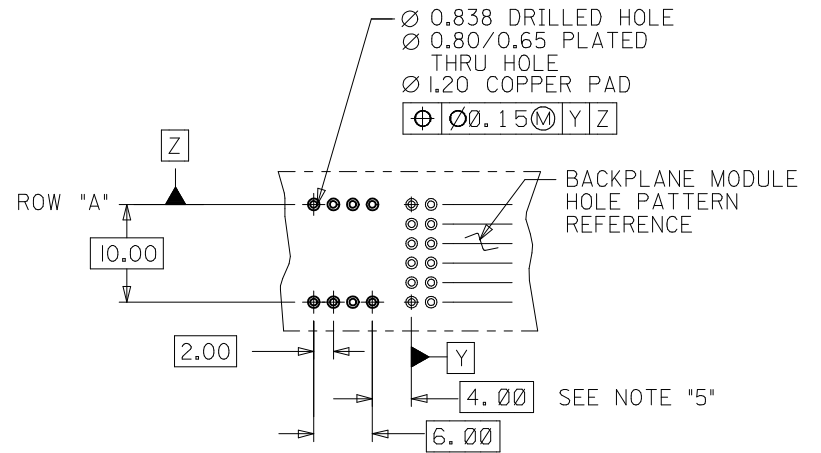

PCB LAYOUT: COMPONENT SIDE
RECOMMENDED PCB THICKNESS: 2.50 MIN

SEE SHEET 1 EC NO: UCP2009-1813 DRWN:SDANNELLEY 2009/07/17 CHKD:BSMART 2009/07/24 APPR:SMILLER 2009/07/24	DESCRIPTION REV	QUALITY SYMBOLS	GENERAL TOLERANCES (UNLESS SPECIFIED)	DIMENSION STYLE	SCALE	DESIGN UNITS	THIRD ANGLE PROJECTION
		$\nabla=0$ $\nabla=0$	mm INCH 4 PLACES ± --- ± --- 3 PLACES ± --- ± --- 2 PLACES ± --- ± --- 1 PLACE ± --- ± ---	MM ONLY	1:1	METRIC	
		ANGULAR ±1/2°	DRAWN BY: ELO DATE: 1998/05/21 CHECKED BY: SMR DATE: 1998/05/21 APPROVED BY: CAB DATE: 1998/05/21	TITLE	SALES ASSY , HDM BACKPLANE POWER MODULE (PRESSFIT)		
		DRAFT WHERE APPLICABLE MUST REMAIN WITHIN DIMENSIONS	MATERIAL NO. SEE TABLE	MOLEX INCORPORATED	DOCUMENT NO. SDA-73656-*00*	SHEET NO. 4 OF 4	

DATE CODE AND PART NUMBER ON THIS SURFACE OR SURFACE OPPOSITE.

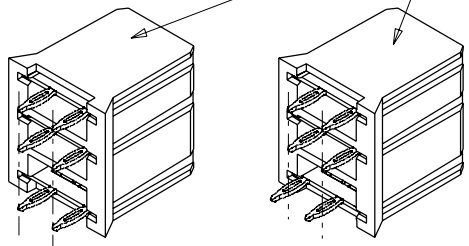

73656-100*

73656-200*

MIDPLANE OPTION

ASSEMBLY NUMBER	FINISH (SEE SHT 1)
73656-1000	SEE NOTE 2. (GOLD TAILS)
73656-2000	
73656-1001	SEE NOTE 3. (TIN/LEAD TAILS)
73656-2001	

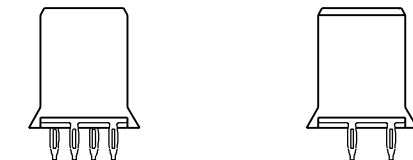
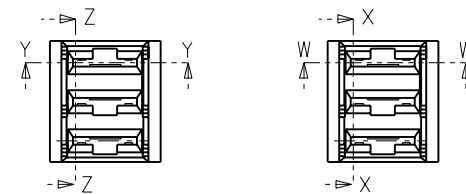

73656-200*

73656-100*

USE BACKPLANE MODULE HOLE REFERENCE PATTERN FROM SHEET 1

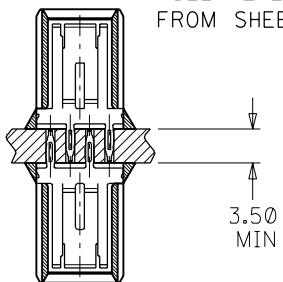

BACK-TO-BACK MOUNTING APPLICATION

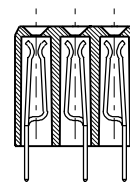

SECTION X-X
SECTION Z-Z
ROTATED 90° CW

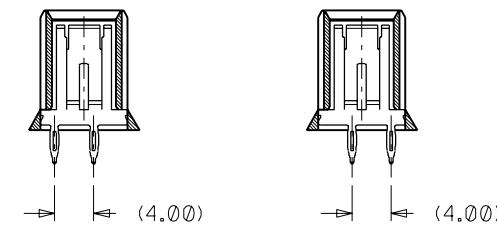

SECTION: Y-Y (4.00)

SECTION: W-W (4.00)

F
E
D
C
B
A

F
E
D
C
B
A

		D	SEE SHEET 1
		B	SEE SHEET 1
		A	SEE SHEET 1
LTR.	REVISIONS	LTR.	REVISIONS

DIMENSIONS SHOWN (METRIC) INCH			
UNLESS OTHERWISE SPECIFIED TOLERANCES: ANGULAR = 1/2°			
	INCH	METRIC	
3 PLACE	± N/A	---	
2 PLACE	± N/A	± ---	
1 PLACE	---	± ---	
DRAFT WHERE APPLICABLE MUST REMAIN WITHIN DIMENSIONS			
DRWG. BY	ELO	CHK'D. BY	SMR
APP'D. BY	CAB	SCALE	2 : 1

REVISE ONLY ON CAD SYSTEM	
TITLE SALES ASSY, HDM BACKPLANE POWER MODULE (PRESS FIT)	
MOLEX INCORPORATED LISLE, ILL. 60532 U.S.A.	SHEET NO. 2 DATE 98/05/21
PART NO.	DRWG. NO.
FILE NAME S73656X2.DGN	SEE CHART SDA-73656-*00*
THIS DRAWING CONTAINS INFORMATION THAT IS PROPRIETARY TO MOLEX INC. AND SHOULD NOT BE USED WITHOUT WRITTEN PERMISSION.	
DIV. DA	SIZE B