

## Features

Package	3216 size Dome Lens Type, Yellow Green color emitting LED
Product features	<ul style="list-style-type: none"><li>•Outer Dimension 3.2 x 1.6 x 1.85mm ( L x W x H )</li><li>•Lead-free soldering compatible</li><li>•RoHS compliant</li></ul>

## Recommended Applications

Light source for switch of Automotive, Mobile equipment, Electric Household Appliances, OA/FA, Other General Applications

# Outline Dimensions

# VFJD1105W-5C63A-TR

UNIT : mm  
 Weight : 7.81mg  
 Tolerance : ±0.1

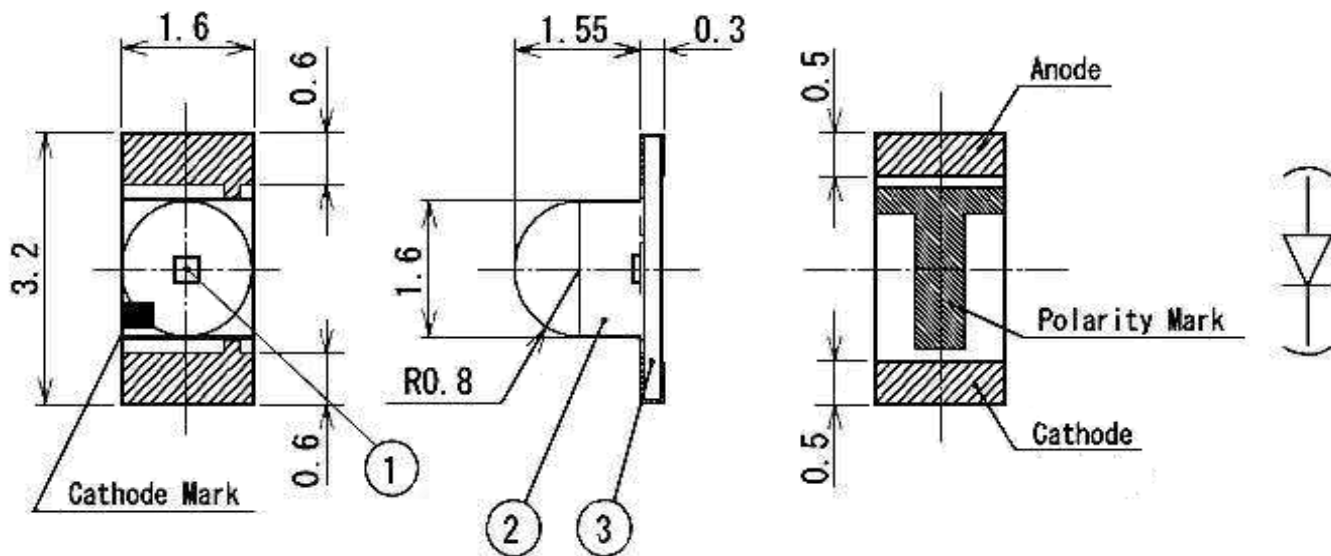

NO.	PART NAME	MATERIAL	QTY.
①	LED Die	AlGaInP	1
②	Mold Resin	Epoxy Resin	1
③	Substrate	Glass Fabrics	1

## Recommended Pad

UNIT : mm

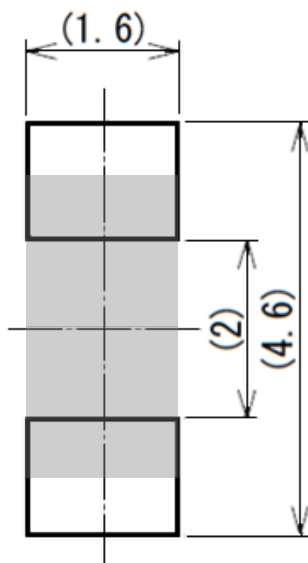

## 【 Product Overview 】

DIE MATERIAL	AlGaInP
EMITTING COLOR	Yellow Green
RESIN COLOR 【EMITTING AREA】	Water Clear

## 【 ABSOLUTE MAXIMUM RATINGS 】

(Ta=25°C)

ITEM	SYMBOL	MAXIMUM RATINGS	UNITS
Power Dissipation	$P_d$	78	mW
Continuous Forward Current	$I_F$	30	mA
Repetitive Peak Forward Current 【1ms, 1/20duty】	$I_{FRM}$	100	mA
IFDerate Linearly【 from Ta=75°C 】	$\Delta I_F$	1.00	mA/°C
IFRMDerate Linearly【 from Ta=75°C 】	$\Delta I_{FRM}$	3.33	mA/°C
Reverse Voltage	$V_R$	5	V
Operating Temperature	$T_{opr}$	-40 ~ +100	°C
Storage Temperature	$T_{stg}$	-40 ~ +105	°C
Electrostatic Discharge Threshold "HBM"	ESD	1,000	V
Soldering Temperature "Reflow Soldering"	$T_{sld}$	260	°C

Note1

Note2

Note1 ESD testing method : EIAJ4701/300(304) Human Body Model(HBM) 1.5k $\Omega$ , 100pF

Note2 Please refer to page 8, soldering conditions.

## 【 Thermal Characteristics 】

(Ta=25°C)

ITEM	SYMBOL	TYP.	MAX.	UNITS
Thermal resistance 【Junction-Ambient】	$R_{th(j-a)}$	650	-	°C/W
Thermal resistance 【Junction-Solder point】	$R_{th(j-s)}$	450	-	°C/W
Junction Temperature	$T_j$	-	105	°C/W

Note3

Note3 Rth(j-a) Measurement Condition

Substrate : FR4(t=1.6mm)

Pattern Size : 16mm<sup>2</sup>

## 【 Electro and Optical Characteristics 】

(Ta=25°C)

ITEM	SYMBOL	CONDITIONS	MIN.	TYP.	MAX.	UNITS
Forward Voltage	$V_F$	$I_F = 20\text{mA}$	-	1.9	2.4	V
Reverse Current	$I_R$	$V_R = 5\text{V}$	-	-	100	$\mu\text{A}$
Luminous Intensity	$I_V$	$I_F = 20\text{mA}$	270	470	680	mcd
Luminous Flux	$\phi_v$	$I_F = 20\text{mA}$	-	200	-	mlm
Peak Wavelength	$\lambda_p$	$I_F = 20\text{mA}$	-	575	-	nm
Dominant Wavelength	$\lambda_d$	$I_F = 20\text{mA}$	567	572	576	nm
Spectral Line Half Width	$\Delta\lambda$	$I_F = 20\text{mA}$	-	15	-	nm
Half Intensity Angle	$2\theta_{1/2}$	$I_F = 20\text{mA}$	-	40	-	deg.

Note Above the table of Luminous Intensity ( $I_V$ ) values and Dominant Wavelength ( $\lambda_d$ ) values are the setup value of the selection machine.

【Tolerance :  $I_V \pm 10\%$ ,  $\lambda_d \pm 1\text{nm}$ 】

## 【 Sorting For Luminous Intensity and Dominant Wavelength 】

LED's shall be sorted out into the following ranks of Luminous Intensity and Dominant Wavelength.

### Luminous Intensity ( $I_V$ ) Rank

Rank	$I_V$ (mcd)		Conditions
	MIN.	MAX.	
C6	270	330	$I_F = 20\text{mA}$ $T_a = 25^\circ\text{C}$
C7	330	390	
C8	390	470	
C9	470	560	
CX	560	680	

### Dominant Wavelength ( $\lambda_d$ ) Rank

Rank	$\lambda_d$ (nm)		Conditions
	MIN.	MAX.	
A	567	570	$I_F = 20\text{mA}$ $T_a = 25^\circ\text{C}$
B	570	573	
C	573	576	

Notes Above the table of Luminous Intensity ( $I_V$ ) values and Dominant Wavelength ( $\lambda_d$ ) values are the setup value of the selection machine.

【Tolerance :  $I_V \dots \pm 10\%$ ,  $\lambda_d \dots \pm 1\text{nm}$ 】

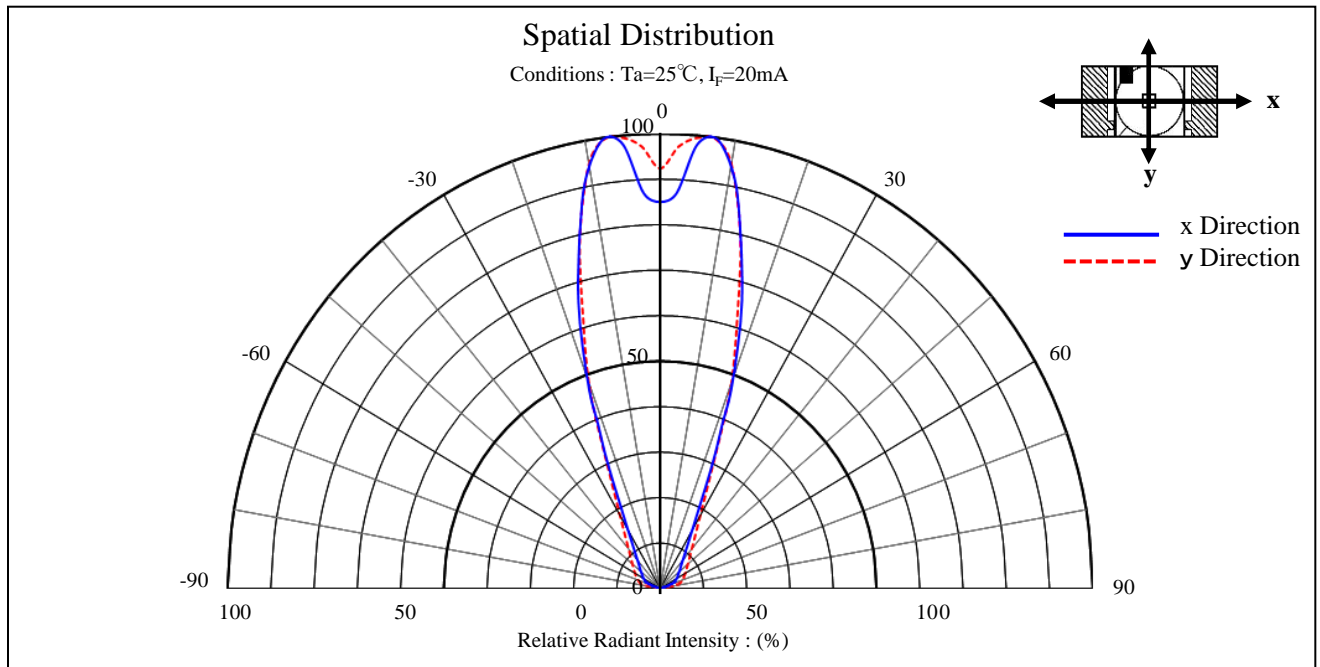
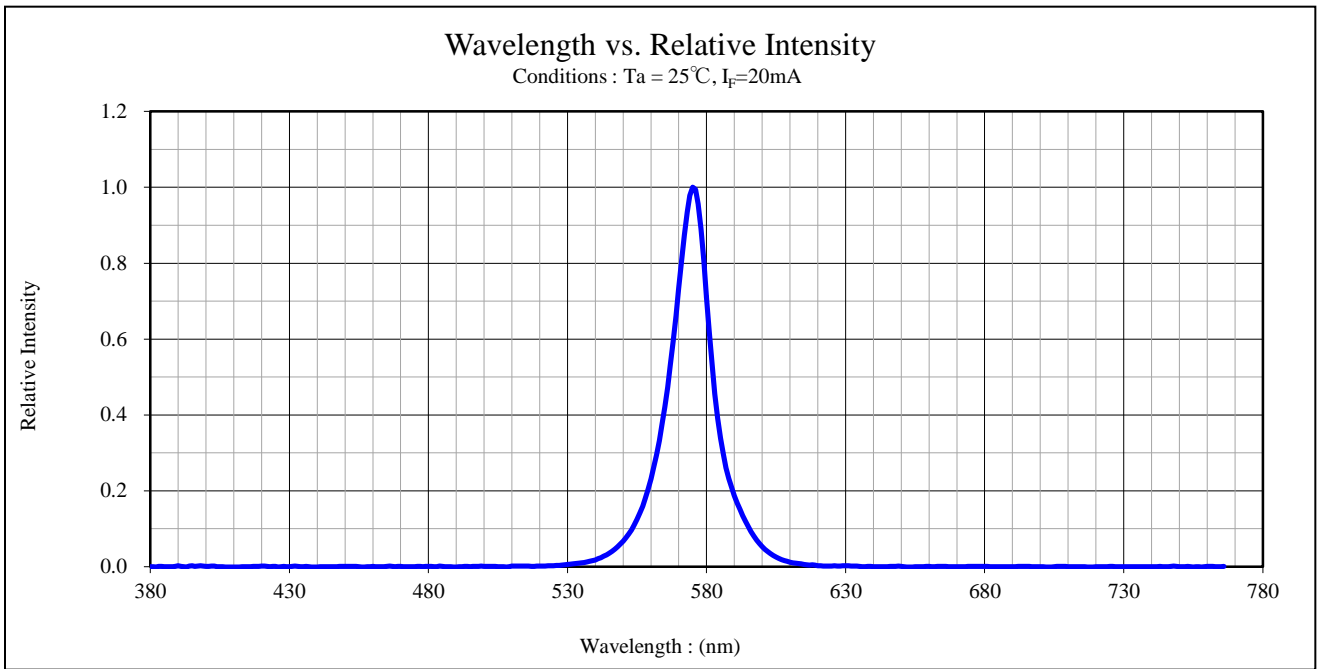

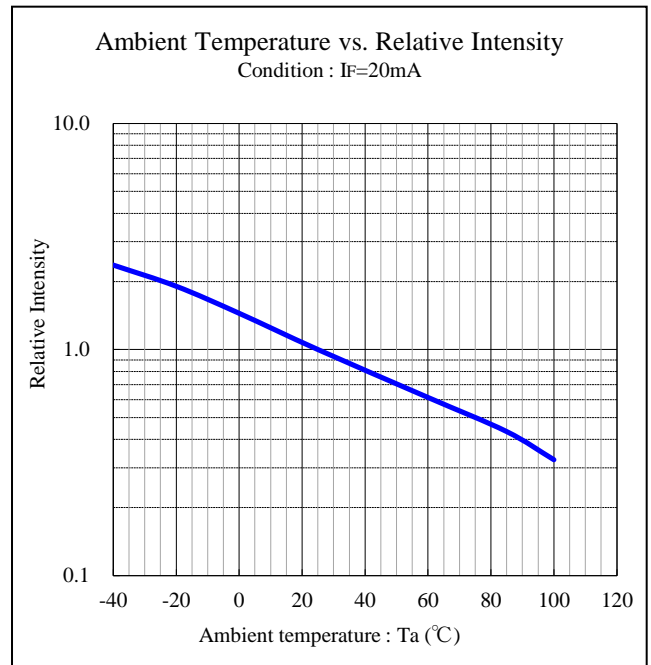
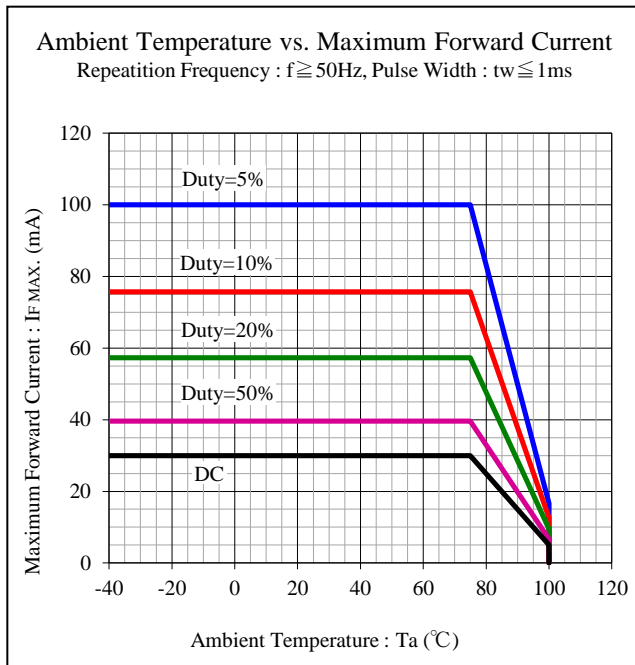
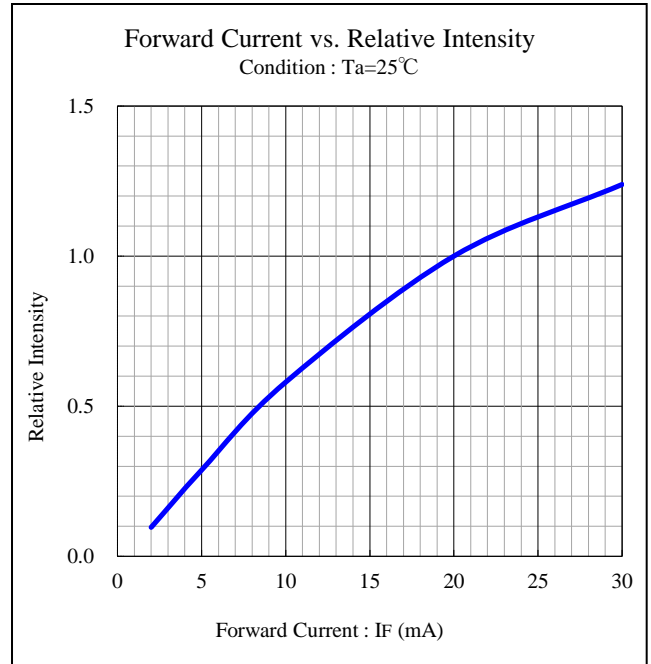
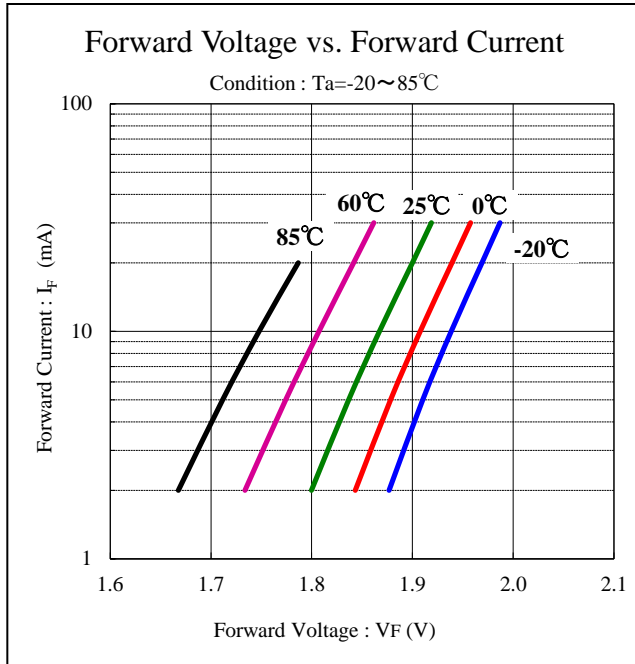

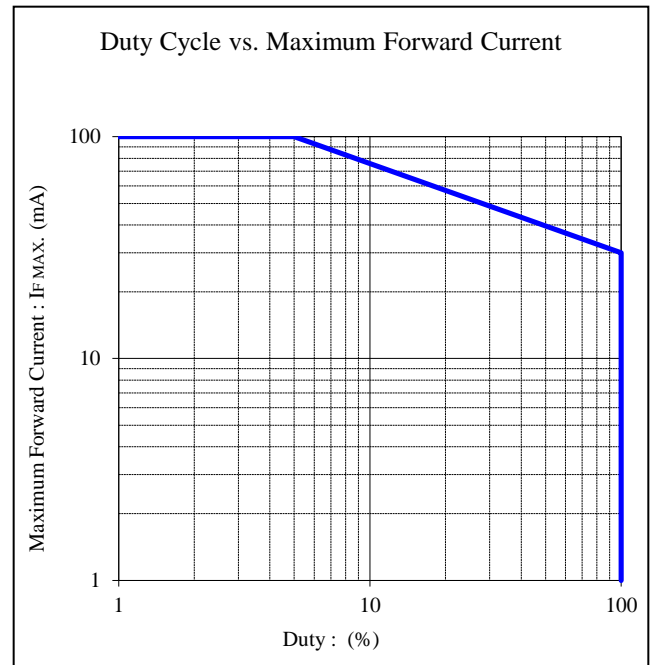
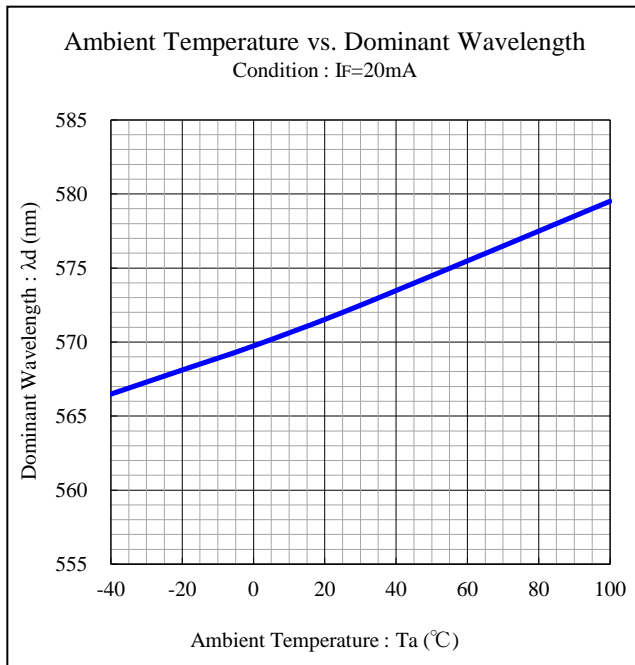
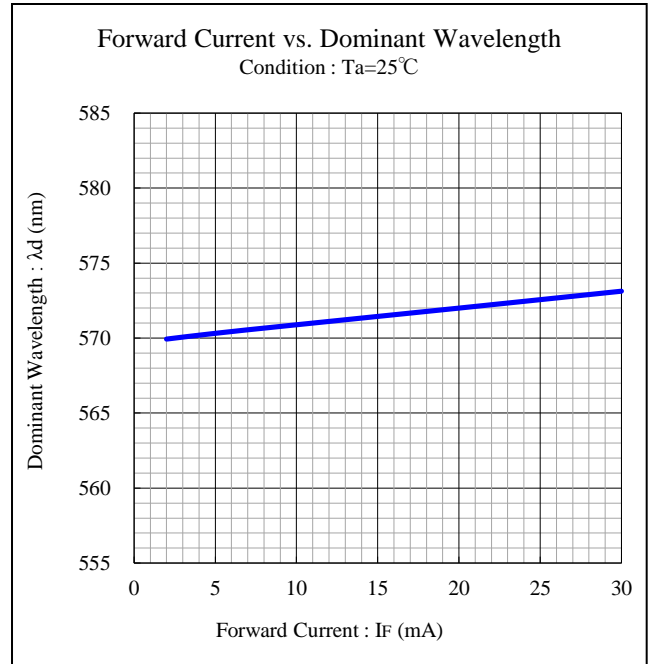
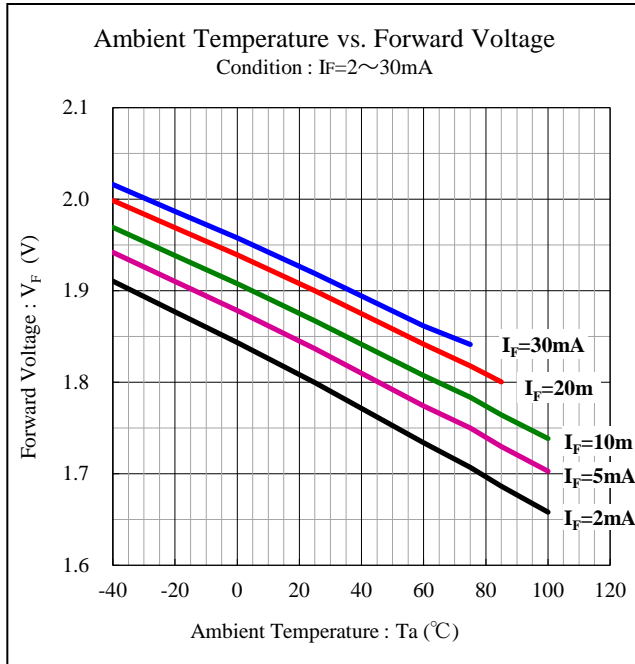

## 1. Reflow Soldering

### 【 Recommended Reflow Soldering Condition 】

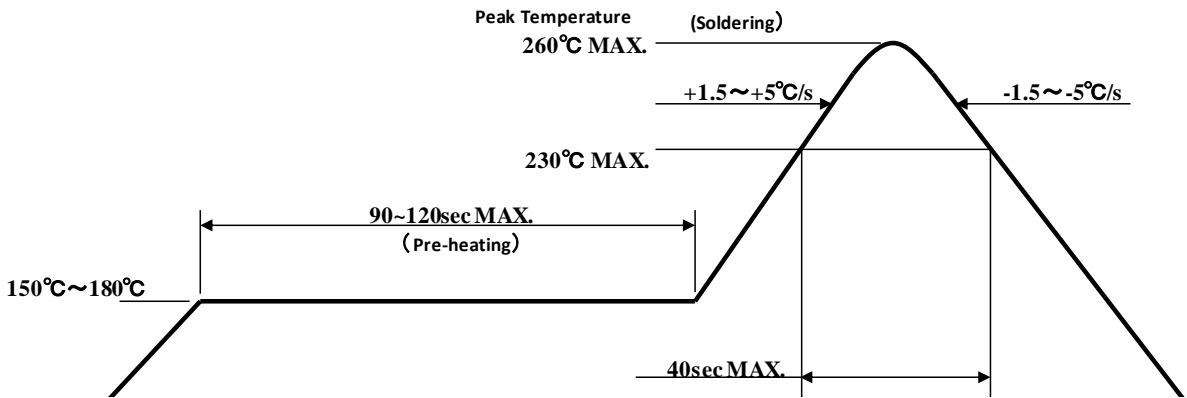

1. The above temp. profile shall be at the surface of LED resin.
2. The number of reflow process shall be 2 time MAX. If second reflow process would be performed, intervals between first and second process shall be as short as possible to prevent absorption of moisture to resin of LED. Cooling process to normal temp. shall be required between first and second reflow process.
3. Temp. fluctuation to LED at pre-heat process shall be minimized.

## 2. Manual Soldering (Soldering iron)

Temperature of Iron Tip	350°C MAX.
Soldering Duration, Time	3sec. Max., 1 time

※ The number of manual soldering process shall be 1 time.

## 3. Other Caution

- 1) As manual soldering, please heat the solder pad, should not contact a tip of iron to a product (especially resin).
- 2) Heat or UV(or both) curing resin shall used for preliminary fixing.  
Curing condition temp. : 150 °C MAX. , time : 120s MAX.
- 3) After soldering, any mechanical force or any excess vibration shall not be accepted to apply during cooling process to normal temp.

## 4. Precaution for Mounting

1. This product is lens type. Nozzle should be used that a diameter of nozzle inside is  $\Phi 1.7 \sim \Phi 1.8$ mm.



## 1. Cleaning

1. Special care shall be taken when applying the chemicals listed below for cleaning because certain chemicals may damage the surface of lens or care and cause discoloration.

Chemical	Adaptability
Ethyl Alcohol	○
Isopropyl Alcohol	○
Pure Water	○
Trichloroethylene	×
Chloroethene	×
Acetone	×
Thinner	×

- ※ Dipping time is 3minutes MAX. (In normal temp.)
- ※ It can be cleaned on the next page conditions, about pure water.

2. Effect of ultrasonic cleaning on the LED resin body differs depending on such factors as the oscillator output, size of P.C.B. and LED mounting method. So the use of ultrasonic cleaning is strongly recommended after confirming that there is no problem.
3. When using Freon equivalent solvent, discoloration on the LED surface may be caused by one of the first confirming that there is no problem.
  - ※ Freon substitute detergent
    - Clean through 750H
    - Pine alpha ST-100S
4. In the case of water-washing , ensure to use pure water (not city water) and , immediately after the washing is over, apply forced drying to remove all the moisture from the LED.

## 【Other Precautions】

1. The products are designed to achieve higher performance reliability, however, they can be influenced by usage conditions.
2. Absolute maximum ratings are set to prevent LED products from failing due to excess stress (temperature, current, voltage, etc.). These ratings must never be overrun even for a moment.
3. To achieve the highest performance reliability, it is necessary to take into account, factors such as forward voltage adjusted to the usage temperature condition, derating of the power consumption, and other variable factors.
4. Please insert Straight Protective Resistors into the circuit in order to stabilize LED operation and to prevent the device from igniting due to excess current.
5. Please check the actual performance in the assembly because the Specification Sheets are described for LED device only.
6. Please refrain from looking directly at the light source of LED at high output, as it may harm your vision.
7. The products are designed to operate without failure in recommended usage conditions. However, please take the necessary precautions to prevent fire, injury, and other damages should any malfunction or failure arise.
8. The products are manufactured to be used for ordinary electronic equipment. Please contact our sales staff beforehand when exceptional quality and reliability are required, and the failure or malfunction of the products might directly jeopardize life or health (such as for airplanes, aerospace, transport equipment, medical applications, nuclear reactor control systems and so on)..
9. The product are designed on the assumption for display. They might be unsuitable by the function usages except display, so we do not recommend to use. It is not warrantable for the trouble event in the function usage, and consult us beforehand if they are used by the function usage.
10. The formal specification sheets shall be valid only by exchange of documents by both parties.

This product is baked (moisture removal) before packaging, and is shipped in moisture-proof packaging (as shown below) to minimize moisture absorption during transportation and storage. However, with regard to storing the products, Stanley recommends the use of dry-box under the following conditions is recommended. Moisture-proof bag as the packaging is made of anti-static material but packaging box is not.

## 【Recommended Storage Condition / Products Warranty Period】

Temperature	+5~30°C
Humidity	Under 70%

In the case of the package unopened , 6 months under 【 Recommended Storage Condition 】.  
Please avoid rapid transition from low temp. condition to high temp. condition and storage in corroding and dusty environment.

## 【Time elapsed after Package Opening】

The package should not be opened until immediately prior to its use, and please keep the time frame between package opening and soldering which is **【maximum 168h】**.  
If the device needs to be soldered twice, both soldering operations must be completed within the 168h.

If any components should remain unused, please reseal the package and store them under the conditions described in the 【 Recommended Storage Condition 】 above.

This product must be required to perform baking process (moisture removal) for **at 23( MIN.)~72h (MAX.) , at 60 +/- 5 degrees Celsius** if following conditions apply.

1. In the case of silica gel (blue) which indicates the moisture level within the package, changes or loses its blue color.
2. In the case of time passes for 168h after the package is opened once.

Baking process should be performed after LED having been taken out of the package.

Baking may be performed in the tape-reel form , however if it is performed with the reel stacked over one another, it may cause deformation of the reels and taping materials and later obstruct mounting. Please handle only once it has returned to room temperature. Provided that, baking process shall be 2 times MAX.

**【Moisture-proof Packaging Specification】**

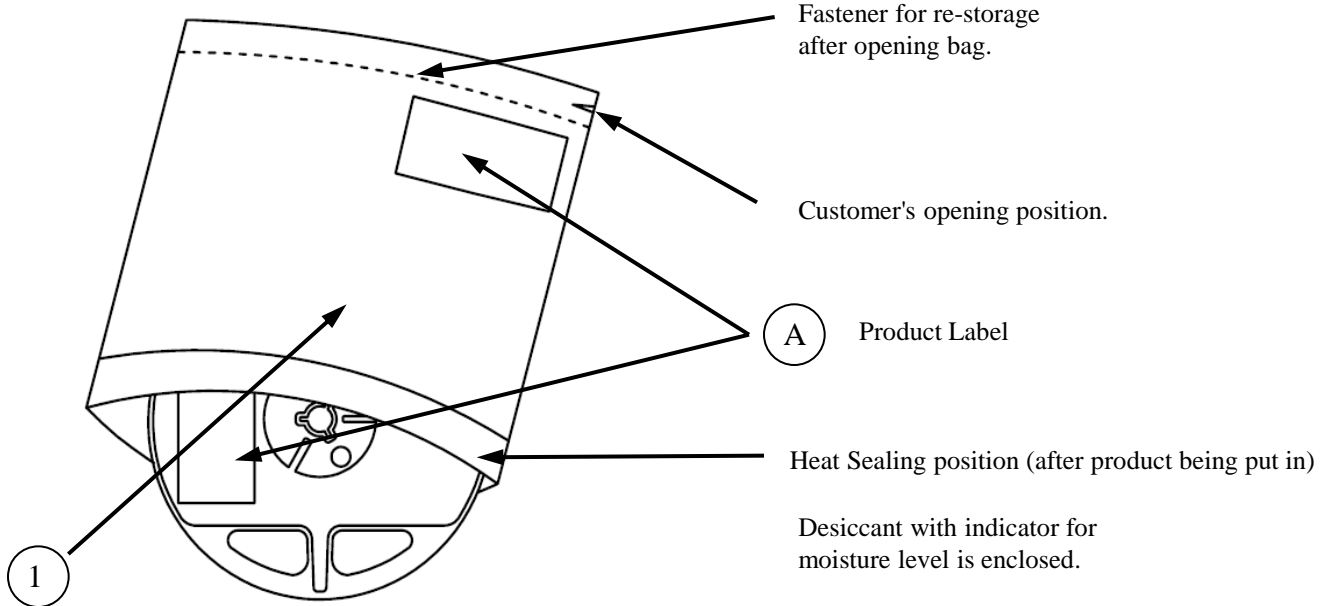

NO.	PART NAME	MATELRIAL	REMARKS
①	Moisture-proof bag with Aluminum layer	PET+Al+PE	with ESD protection

**【Flow Chart-package Opening to Mounting】**

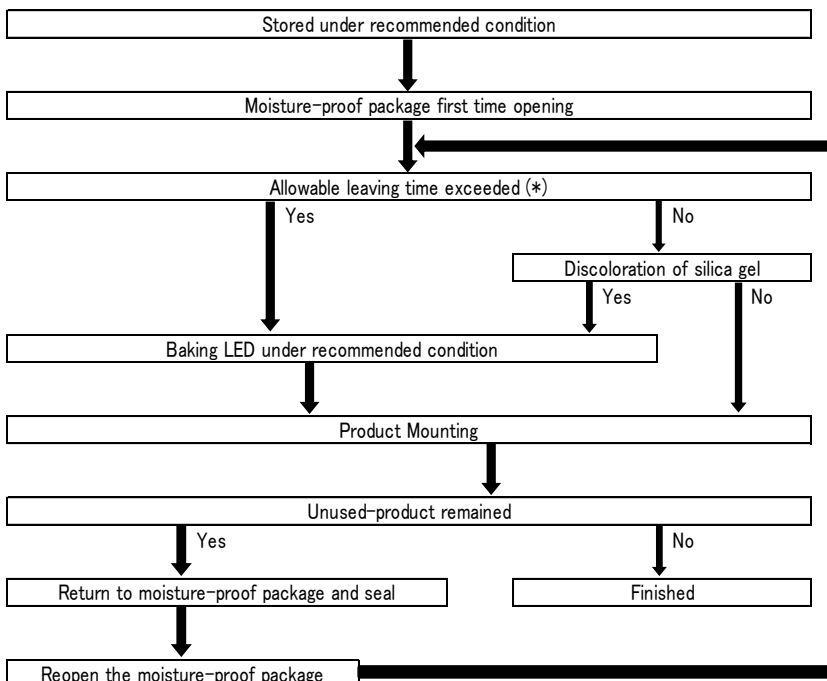

Allowable leaving time means the maximum allowable leaving time after opening package, which depends on each LED type. The allowable leaving time should be calculated from the first opening of package to the time when soldering process is finished. When judging if the allowable leaving time has exceeded or not, please subtract the soldering time after reopening. The allowable leaving time after reopening should be calculated from the first opening of package, or from the time when baking process is finished.

## 【 Packing box 】

Box TYPE	Outline dimension L × W × H (mm)	Capacity of the box
Type A	280 × 265 × 45 (mm)	3 reel
Type B	310 × 235 × 265 (mm)	15 reel
Type C	440 × 310 × 265 (mm)	30 reel

The above measure is all the reference value.

The box is selected out of the above table, by the shipping quantity.

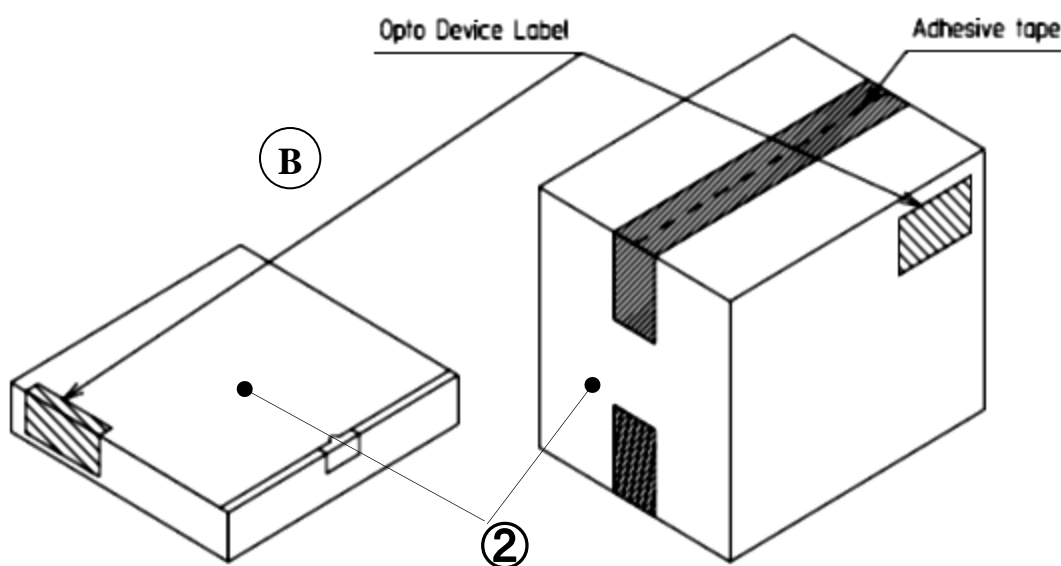

Type A

Material / box : Cardoard C5BF

Type B,C

Material / box : Cardoard K5BF  
Partition : Cardoard K5BF

No.	PART NAME	MATELRIAL	REMARKS
②	Packing Box	Corrugated Cardboard	without ESD protection

## 【 Label Specification】

( acc.to ; JIS-X0503(Code-39)

### A Product label

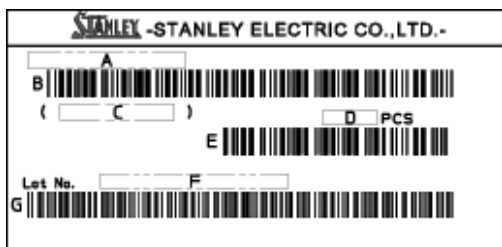

- A. Parts number (Indicated the whole parts number)
- B. Bar-code for parts number
- C. Parts code (In-house identification code for each parts number)
- D. Packed parts quantity (Indicated Parts Qty in the packing)
- E. Bar-Code for packed parts quantity
- F. Lot number & Rank (indicated the following 16 digits)
- G. Bar-Code for Lot number & Rank

### B Opto device label

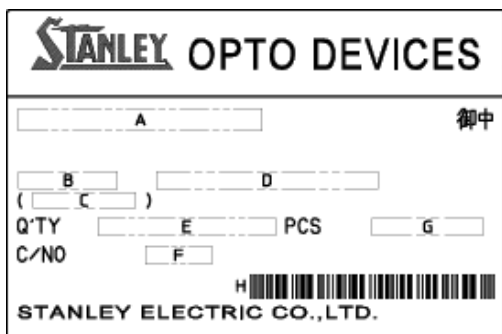

- A. Customer Name
- B. Parts Type
- C. Parts Code
- D. Parts Number
- E. Packed Parts Quantity
- F. Carton Number
- G. Shipping Date
- H. Bar-Code for In-house identification Number

<Remark> Bar-code font : acc.to Code-39(JIX0503)

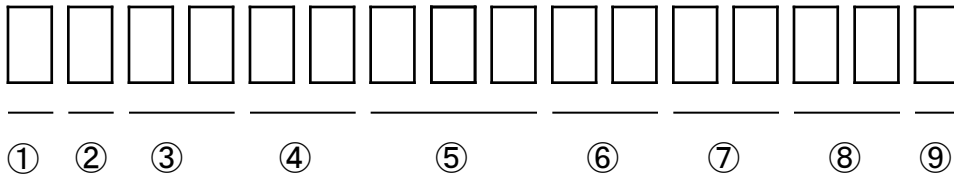

- ① - 1digit : Production Location (Mark identify alphabet)
- ② - 1digit : Production Year (Last Digit of Production Year 2009→9,2010→0,2011→1,···)
- ③ - 2digit : Production Month (Jan. to Sep. ,Should be 01,02,03,·····)
- ④ - 2digit : Production Date
- ⑤ - 3digit : Serial Number
- ⑥ - 2digit : Tape and Reel following Number
- ⑦ - 2digit : Luminous Intensity Rank. (If only 1 digit, second digit must be dash "-"and if not identified rank, its"- -")
- ⑧ - 2digit : Chromaticity Rank (If only 1 digit, second digit must be dash "-"and if not identified rank, its"- -")
- ⑨ - 1digit : Option Rank (Normally its"-")

# Taping and Reel Specifications

# VFJD1105W-5C63A-TR

(acc.to ; JIS-C0806)

## 1. Appearance

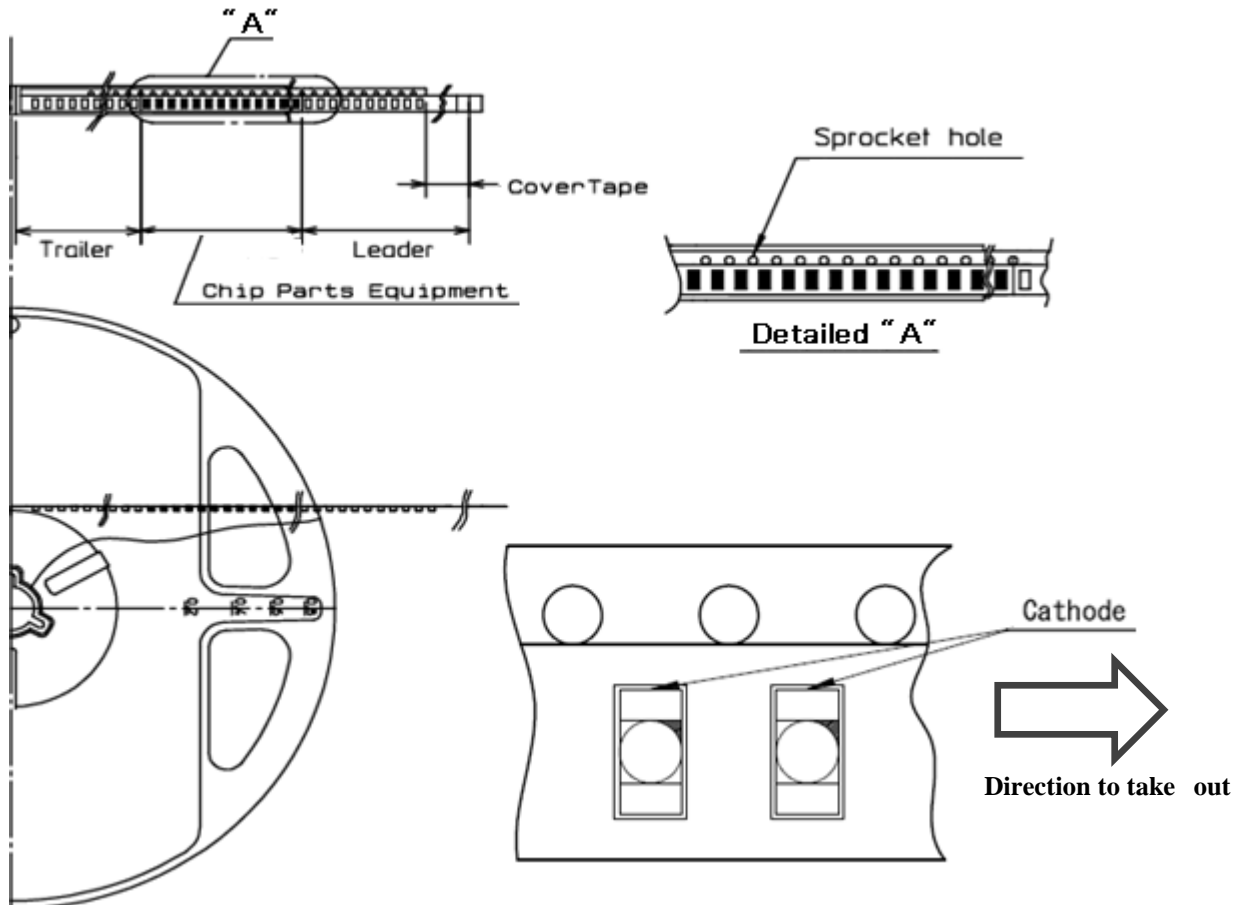

### Note

"-TR" means Cathode Side of LEDs should be placed on the sprocket-hole side.

Items		Specifications	Remarks
Leader area	Cover-tape	Cover-tape shall be longer than 200mm without carrier-tape	The end of cover-tape shall be held with adhesive tape.
	Carrier-tape	Empty pocket shall be more than 10 pieces.	Taping & reel orientation is ; please refer to the above figure.
Trailer area		Empty pocket shall be more than 15 pieces.	The end of taping shall be inserted into a slit of the hub.



# Taping and Reel Specifications

# VFJD1105W-5C63A-TR

## 2. Qty. per Reel

2,000parts/reel

Minimum Qty. per reel might be 500 parts when getting less than 2,000 parts.

In such case, parts of 500-unit-qty. shall be packed in a reel and the qty. shall be identified on the label.

## 3. Mechanical strength

Cover-tape adhesive strength shall be 0.1~1.0N ( An angle between carrier-tape and cover-tape shall be 170 deg. ) Both tapes shall be so sealed that the contained parts will not come out from the tape when it is bent at a radius of 15mm.

## 4. Others

Reversed-orientation, Up-side down placing, side placing and out of spec. parts mix shall not be held.

No more than 1 connecting empty pockets of taping.

Max qty. of empty pocket per reel shall be defined as follows.

Qty./reel	Max. qty. of empty pocket	Remark
500	1	-
1,000	1	-
1,500	1	-
2,000	2	No continuance

# Taping and Reel Specifications

# VFJD1105W-5C63A-TR

(acc.to ; JIS-C0806)

## 5. Taping Dimensions

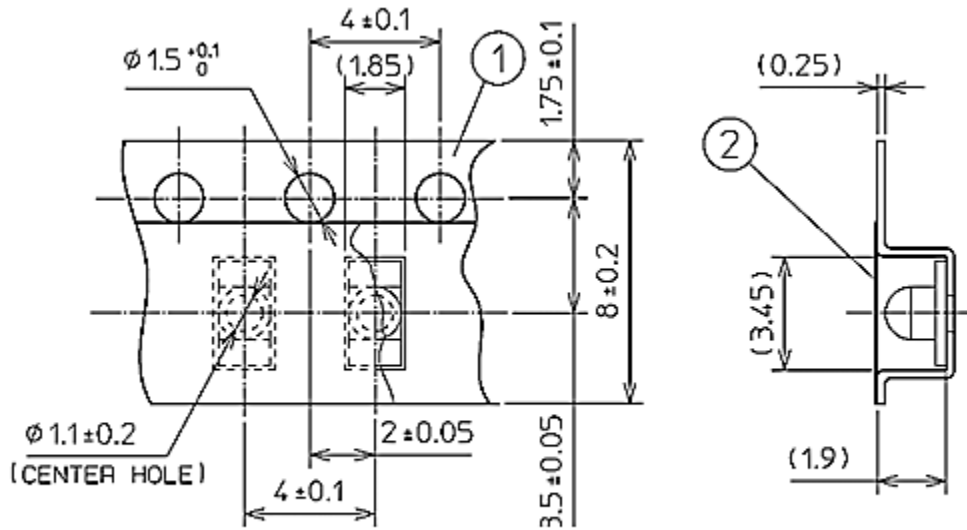

## 6. Reel Dimensions

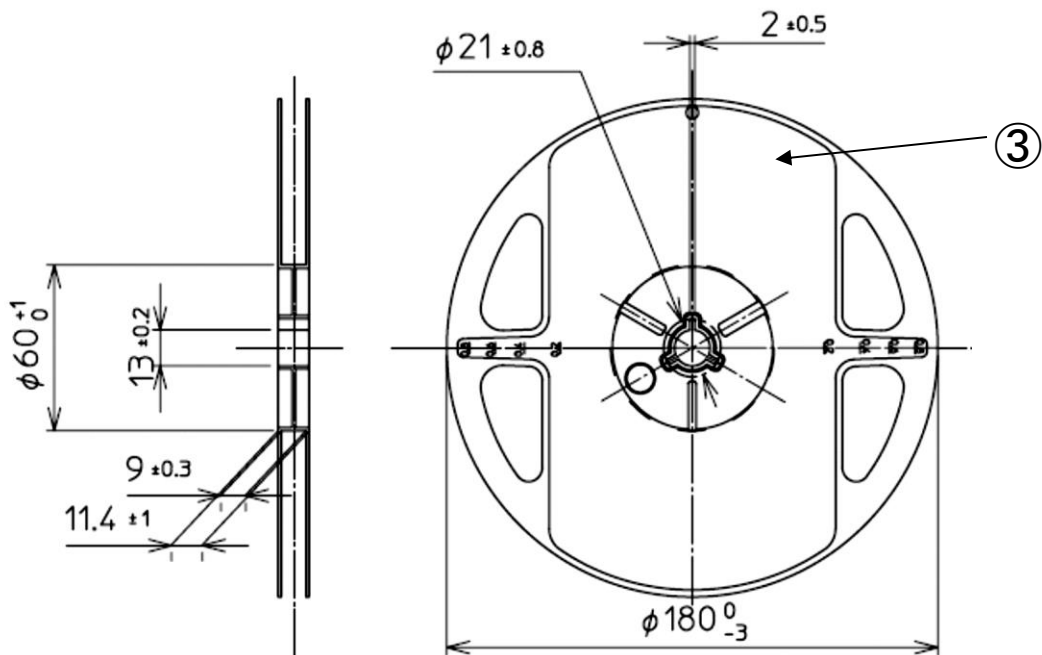

NO.	PART NAME	REMARKS
①	Carrier-tape	Without ESD protection
②	Cover-tape	With ESD protection
③	Carrier-reel	With ESD protection

This product is in compliance with RoHS・ELV.

Prohibition substance and it's criteria value of RoHS・ELV are as follows.

- RoHS instruction ..... Refer to following (1)~(6).
- ELV instruction ..... Refer to following (1)~(4).

	Substance Group Name	Criteria Value
(1)	Lead and its compounds	1,000ppm Max
(2)	Cadmium and its compounds	100ppm Max
(3)	Mercury and its compounds	1,000ppm Max
(4)	Hexavalent chromium	1,000ppm Max
(5)	PBB	1,000ppm Max
(6)	PBDE	1,000ppm Max

# Reliability Testing Result

# VFJD1105W-5C63A-TR

Test Item	Reference Standard	Test Condition	Duration	Failure
Operating Life	EIAJ ED-4701 /100(101)	Ta=25°C Maximum Rated Current	1,000h	0 / 20
High Temperature Operating Life	EIAJ ED-4701 /100(101)	Ta=85°C Maximum Rated Current ※1	1,000h	0 / 20
Low Temperature Operating Life	EIAJ ED-4701 /100(101)	Ta=-40°C Maximum Rated Current	1,000h	0 / 20
Wet High Temperature Operating Life	EIAJ ED-4701 /100(102)	Ta=60°C Rh=90% Maximum Rated Current	1,000h	0 / 20
High Temperature Storage Life	EIAJ ED-4701 /200(201)	Ta=Tstg max. Maximum Storage Temperature	1,000h	0 / 20
Low Temperature Storage Life	EIAJ ED-4701 /200(202)	Ta=Tstg min. Minimum Storage Temperature	1,000h	0 / 20
Wet High Temperature storage Life	EIAJ ED-4701 /100(101)	Ta=60°C Rh=90%	1,000h	0 / 20
Thermal Shock	EIAJ ED-4701 /100(105)	Ta=Tstg max. ~ Tstg min. (each 15min)	1000 cycles	0 / 20
Thermal Shock Operating	EIAJ ED-4701 /100(105)	Ta=-40°C(OFF) ~ 85°C(ON /Maximum Rated Current (each 15min)	1000 cycles	0 / 20
Cycled Temperature Humidity Life	EIAJ ED-4701 /200(203)	Ta=-30°C ~ 80°C 95% 8h/cycles 5min on-off (Maximum Rated Current	30 cycles	0 / 20
Resistance to Reflow Soldering	EIAJ ED-4701 /300(301)	Moisture Soak : 30°C 70% 72h Preheating : 150~180°C 120sec MAX. Soldering : 260°C 5sec	2times	0 / 20
Electric Static Discharge(ESD) ※2	EIAJ ED-4701 /300(304)	C=100pF R2=1.5KΩ ±2000V	once of each polarity	0 / 10
Vibration, Variable Frequency	EIAJ ED-4701 /400(403)	98.1m/s <sup>2</sup> (10G) 100~2000Hz 20min sweep XYZ direction	2h of each direction	0 / 10

※1 Maximum rated current at maximum rated operating temperature.

※2 Reference test

## Failure Criteria

Item	Symbol	Condition	Criteria
Luminous Intensity	I <sub>V</sub>	I <sub>F</sub> Value of each product Luminous Intensity	Testing Min. Value < Standard Min. Value × 0.5
Forward Voltage	V <sub>F</sub>	I <sub>F</sub> Value of each product Forward Voltage	Testing Max. Value ≥ Standard Max. Value × 1.2
Reverse Current	I <sub>R</sub>	V <sub>R</sub> =5V	Testing Max. Value ≥ Standard Max. Value × 2.5
Cosmetic appearance	-	-	No notable, decoloration, deformation and cracking

## Special Notice to Customers Using the Products and Technical Information Shown in This Data Sheet

- 1) The technical information shown in the data sheets are limited to the typical characteristics and circuit examples of the referenced products. It does not constitute the warranting of industrial property nor the granting of any license.
- 2) For the purpose of product improvement, the specifications, characteristics and technical data described in the data sheets are subject to change without prior notice. Therefore it is recommended that the most updated specifications be used in your design.
- 3) When using the products described in the data sheets, please adhere to the maximum ratings for operating voltage, heat dissipation characteristics, and other precautions for use. We are not responsible for any damage which may occur if these specifications are exceeded.
- 4) The products that have been described to this catalog are manufactured so that they will be used for the electrical instrument of the benchmark (OA equipment, telecommunications equipment, AV machine, home appliance and measuring instrument).  
The application of aircrafts, space borne application, transportation equipment, medical equipment and nuclear power control equipment, etc. needs a high reliability and safety, and the breakdown and the wrong operation might influence the life or the human body. Please consult us beforehand if you plan to use our product for the usages of aircrafts, space borne application, transportation equipment, medical equipment and nuclear power control equipment, etc. except OA equipment, telecommunications equipment, AV machine, home appliance and measuring instrument.
- 5) In order to export the products or technologies described in this data sheet which are under the “Foreign Exchange and Foreign Trade Control Law,” it is necessary to first obtain an export permit from the Japanese government.
- 6) No part of this data sheet may be reprinted or reproduced without prior written permission from Stanley Electric Co., Ltd.
- 7) The most updated edition of this data sheet can be obtained from the address below:  
<http://www.stanley-components.com/en>