

## MIRELLA-G2-M

~25° wide beam. Compatible with LEDiL HEKLA.

### TECHNICAL SPECIFICATIONS:

Dimensions	Ø 49.9 mm
Height	22.6 mm
Fastening	socket
Colour	metal
Box size	480 x 280 x 300 mm
Box weight	5.4 kg
Quantity in Box	336 pcs
ROHS compliant	yes ⓘ



### MATERIAL SPECIFICATIONS:



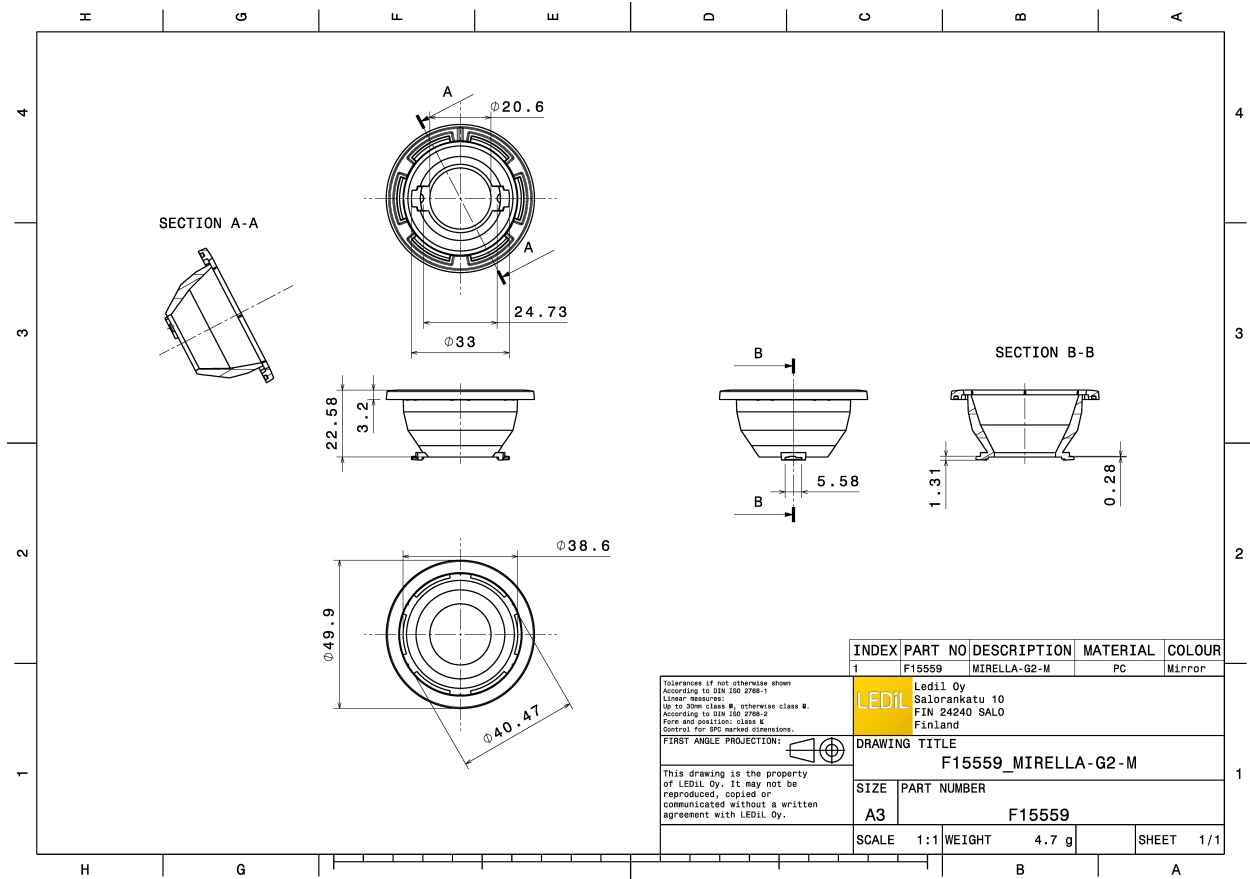

Component	Type	Material	Colour	Coating
MIRELLA-G2-M	Reflector	PC	metal	

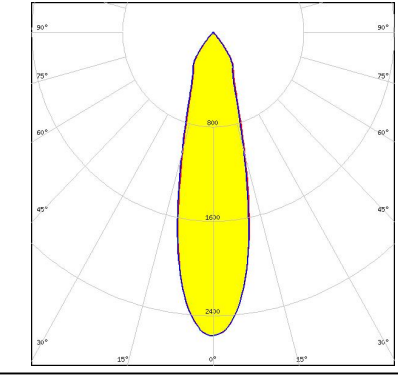
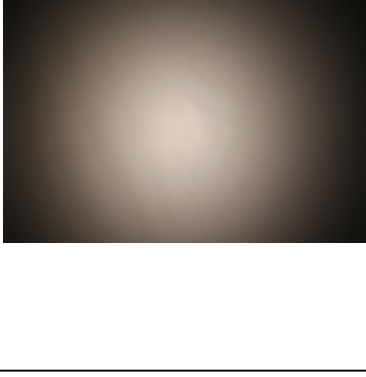
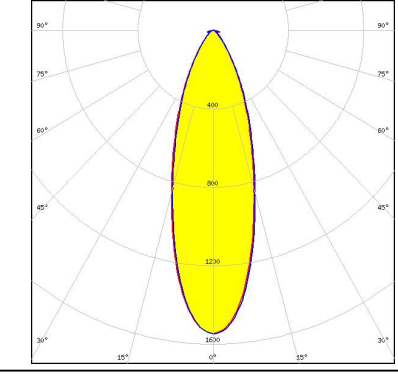
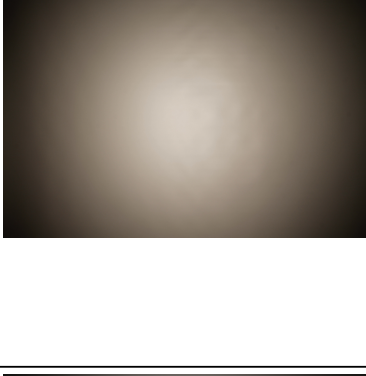
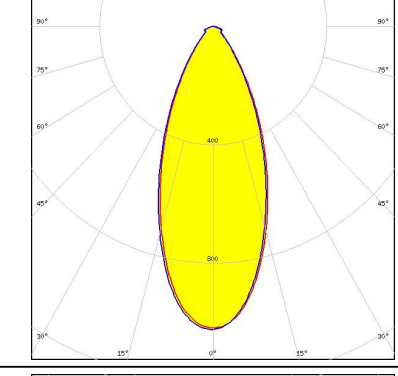
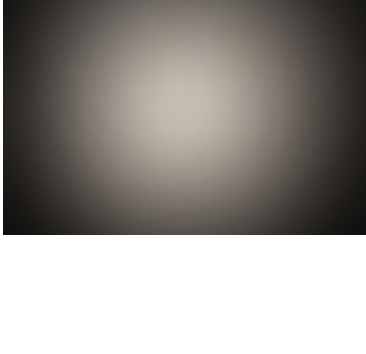
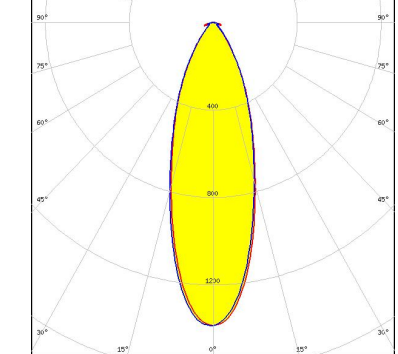

#### PHOTOMETRIC DATA (MEASURED):

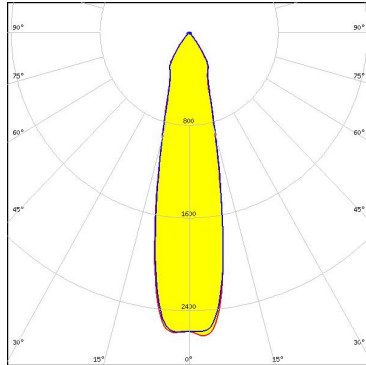
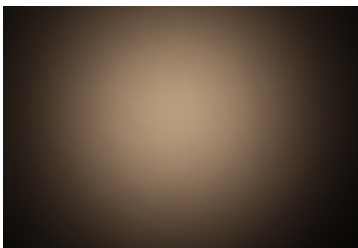
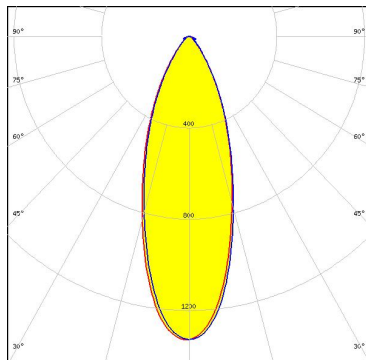
<p>bridgelux.</p> <p>LED VERO10</p> <p>FWHM 27.0°</p> <p>Efficiency 90 %</p> <p>Peak intensity 2.600 cd/lm</p> <p>Required components: F15616_HEKLA-SOCKET-F</p>		
<p>bridgelux.</p> <p>LED Vesta DTW 9mm (6W/12W)</p> <p>FWHM 33.0°</p> <p>Efficiency 77 %</p> <p>Peak intensity 1.500 cd/lm</p> <p>Required components: C16142_HEKLA-SOCKET-K C13723_MIRELLA-RZL Bender Wirth: 490 Typ L8</p>		
<p>bridgelux.</p> <p>LED Vesta TW 13mm (25W)</p> <p>FWHM 43.0°</p> <p>Efficiency 77 %</p> <p>Peak intensity 1.000 cd/lm</p> <p>Required components: C16142_HEKLA-SOCKET-K C13723_MIRELLA-RZL Bender Wirth: 492 Typ L8</p>		
<p>bridgelux.</p> <p>LED Vesta TW 9mm (12W)</p> <p>FWHM 33.0°</p> <p>Efficiency 74 %</p> <p>Peak intensity 1.400 cd/lm</p> <p>Required components: C16142_HEKLA-SOCKET-K C13723_MIRELLA-RZL Bender Wirth: 489 Typ L8</p>		

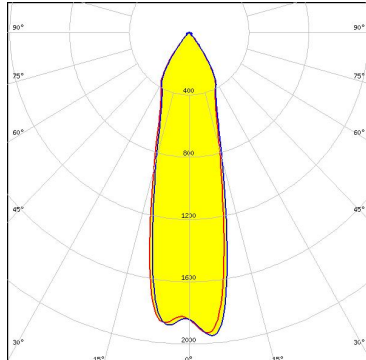
#### PHOTOMETRIC DATA (MEASURED):

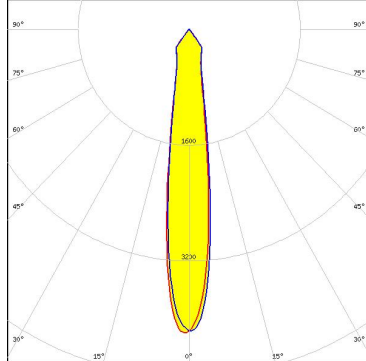
<p>bridgelux</p> <p>LED Vesta TW 9mm (12W)</p> <p>FWHM 25.0°</p> <p>Efficiency 84 %</p> <p>Peak intensity 2.600 cd/lm</p> <p>Required components: C16142_HEKLA-SOCKET-K Bender Wirth: 490 Typ L8</p>		
<h3>CITIZEN</h3> <p>LED CLC020 Series (Dim-To-Warm)</p> <p>FWHM 36.0°</p> <p>Efficiency 74 %</p> <p>Peak intensity 1.300 cd/lm</p> <p>Required components: C16142_HEKLA-SOCKET-K C13723_MIRELLA-RZL Bender Wirth: 487 Typ L8</p>		
<h3>CITIZEN</h3> <p>LED CLC020 Series (Dim-To-Warm)</p> <p>FWHM 28.0°</p> <p>Efficiency 80 %</p> <p>Peak intensity 2.000 cd/lm</p> <p>Required components: C16142_HEKLA-SOCKET-K</p>		
<h3>CITIZEN</h3> <p>LED CLU LES 4.2mm (HI-Ver.3)</p> <p>FWHM 16.0°</p> <p>Efficiency 87 %</p> <p>Peak intensity 4.200 cd/lm</p> <p>Required components: F15255_HEKLA-SOCKET-C</p>		

#### PHOTOMETRIC DATA (MEASURED):

#### CITIZEN

LED CLU025/CLU027 (LES 6)  
 FWHM 20.0°  
 Efficiency 87 %  
 Peak intensity 3.400 cd/lm  
 Required components:  
 F15255\_HEKLA-SOCKET-C

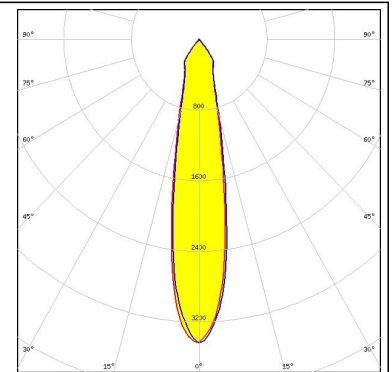

#### CITIZEN

LED CLU700/701  
 FWHM 19.0°  
 Efficiency 90 %  
 Peak intensity 4.000 cd/lm  
 Required components:  
 C15743\_XTM-ADAPTER-50-B  
 LEDiL: F15255\_HEKLA-SOCKET-C

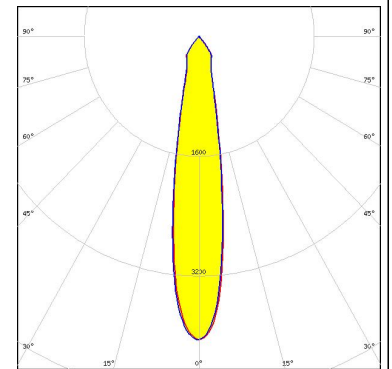

#### CITIZEN

LED CLU710/711  
 FWHM 26.0°  
 Efficiency 85 %  
 Peak intensity 2.300 cd/lm  
 Required components:  
 F15859\_HEKLA-SOCKET-I

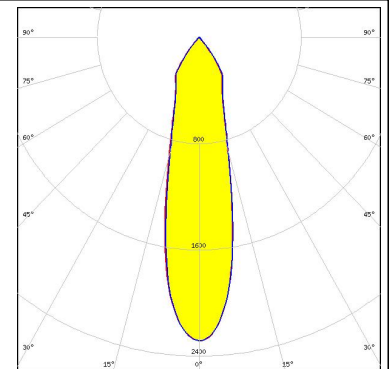
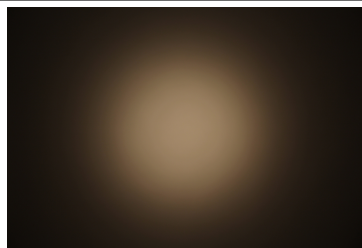

#### CITIZEN

LED LCN-C01B (Tunable White)  
 FWHM 35.0°  
 Efficiency 75 %  
 Peak intensity 1.500 cd/lm  
 Required components:  
 C16142\_HEKLA-SOCKET-K  
 C13723\_MIRELLA-RZL  
 Bender Wirth: 481 Typ L8

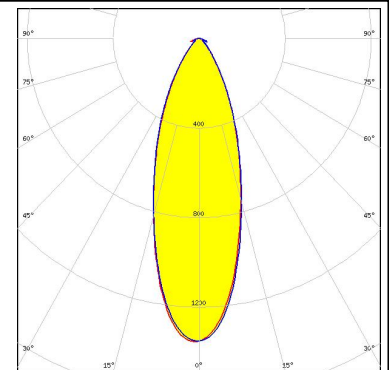
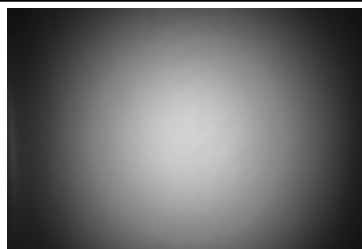

#### PHOTOMETRIC DATA (MEASURED):



LED CMA1516  
 FWHM 30.0°  
 Efficiency 85 %  
 Peak intensity 1.800 cd/lm  
 Required components:  
 F15256\_HEKLA-SOCKET-D

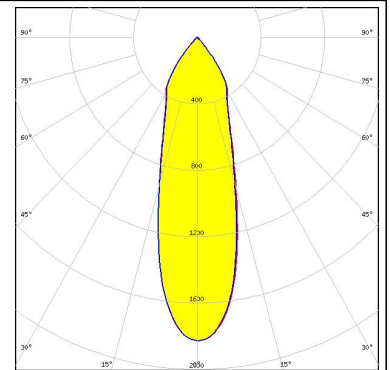
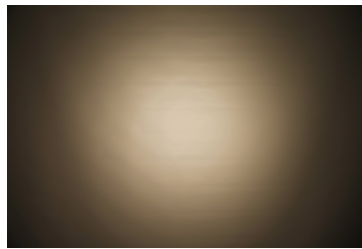

LED CXA/B 13xx  
 FWHM 19.0°  
 Efficiency 91 %  
 Peak intensity 4.100 cd/lm  
 Required components:  
 F15956\_HEKLA-SOCKET-J  
 C13333\_MIRELLA-CL

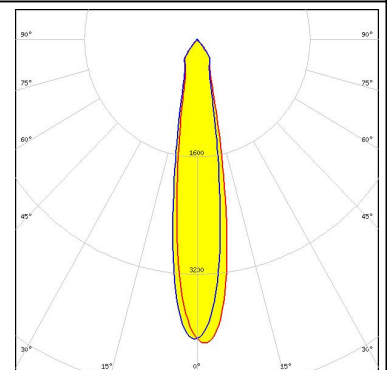

LED CXA/B 15xx  
 FWHM 25.0°  
 Efficiency 91 %  
 Peak intensity 2.900 cd/lm  
 Required components:  
 F15256\_HEKLA-SOCKET-D

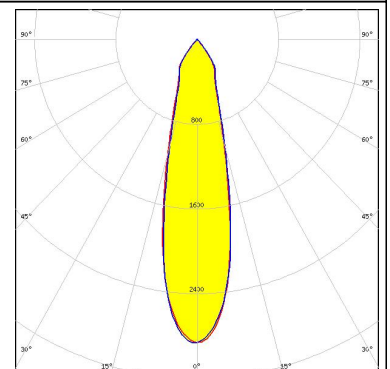
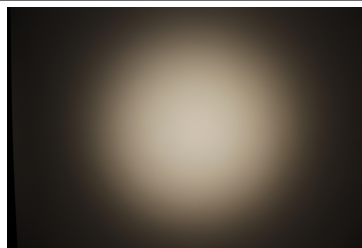

LED LUXEON CoB 1202/1203  
 FWHM 27.0°  
 Efficiency 89 %  
 Peak intensity 2.500 cd/lm  
 Required components:  
 F15858\_HEKLA-SOCKET-H  
 C12479\_MIRELLA-DL

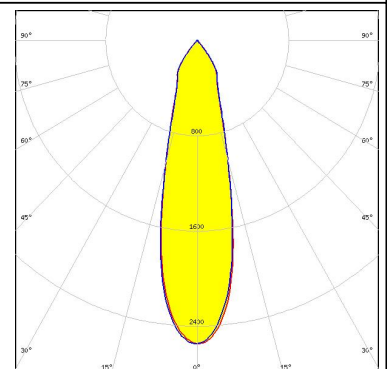
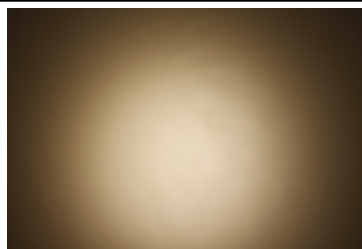

#### PHOTOMETRIC DATA (MEASURED):



LED CDM-6 (Dim-To-Warm)  
 FWHM 20.0°  
 Efficiency 82 %  
 Peak intensity 3.200 cd/lm  
 Required components:  
 C16142\_HEKLA-SOCKET-K  
 Bender Wirth: 490 Typ L8

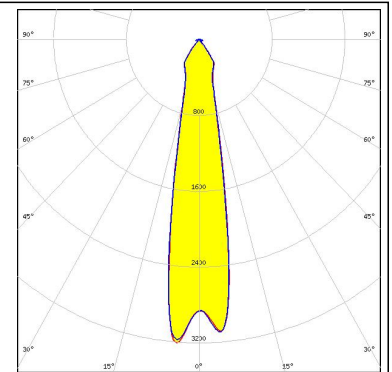

LED CDM-6 (Dim-To-Warm)  
 FWHM 28.0°  
 Efficiency 75 %  
 Peak intensity 1.700 cd/lm  
 Required components:  
 C16142\_HEKLA-SOCKET-K  
 C13723\_MIRELLA-RZL  
 Bender Wirth: 490 Typ L8

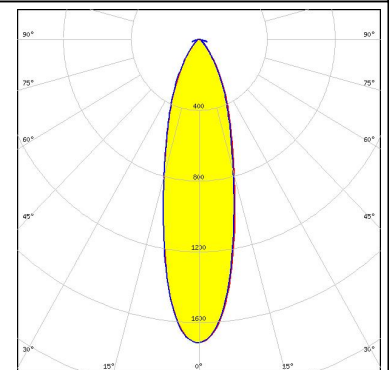
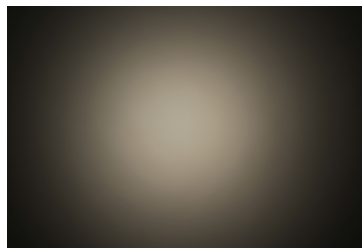



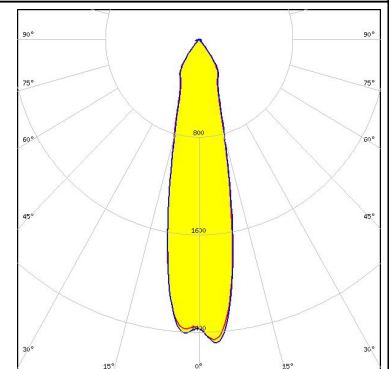
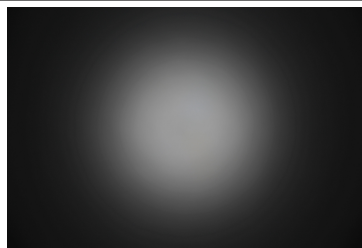

LED CDM-9 (Dim-To-Warm)  
 FWHM 24.0°  
 Efficiency 81 %  
 Peak intensity 2.500 cd/lm  
 Required components:  
 C16142\_HEKLA-SOCKET-K  
 Bender Wirth: 490 Typ L8

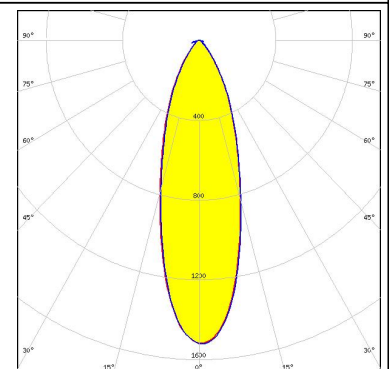
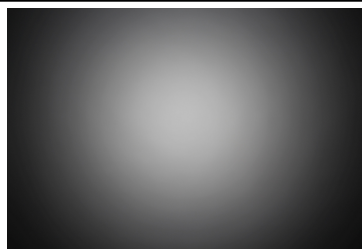

LED CDM-9 (Dim-To-Warm)  
 FWHM 32.0°  
 Efficiency 74 %  
 Peak intensity 1.500 cd/lm  
 Required components:  
 C16142\_HEKLA-SOCKET-K  
 C13723\_MIRELLA-RZL  
 Bender Wirth: 490 Typ L8

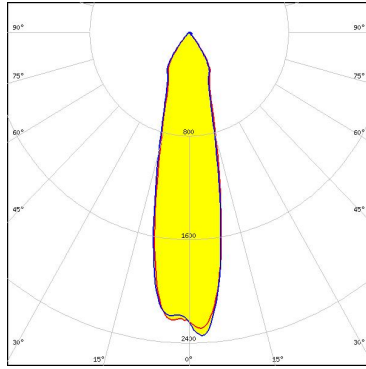
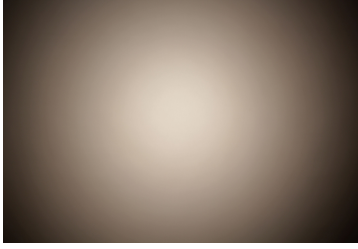
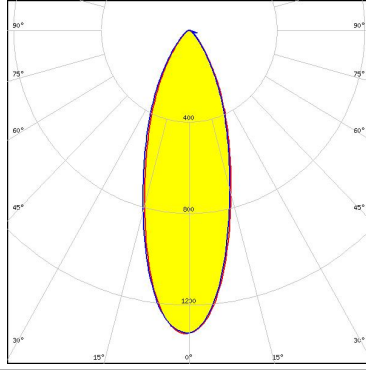

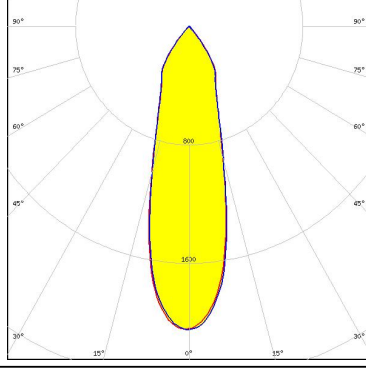
#### PHOTOMETRIC DATA (MEASURED):

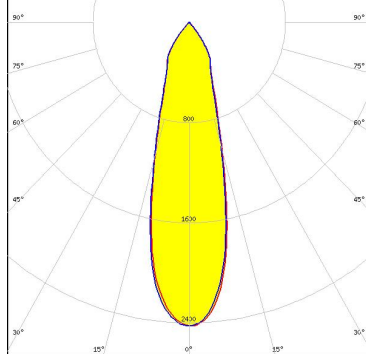
<p><b>LUMINUS</b></p> <p>LED CTM-9 (Tunable White)</p> <p>FWHM 25.0°</p> <p>Efficiency 80 %</p> <p>Peak intensity 2.400 cd/lm</p> <p>Required components: C16142_HEKLA-SOCKET-K Bender Wirth: 495 Typ L8</p>		
<p><b>LUMINUS</b></p> <p>LED CTM-9 (Tunable White)</p> <p>FWHM 34.0°</p> <p>Efficiency 72 %</p> <p>Peak intensity 1.300 cd/lm</p> <p>Required components: C16142_HEKLA-SOCKET-K C13723_MIRELLA-RZL Bender Wirth: 495 Typ L8</p>		
<p><b>LUMINUS</b></p> <p>LED CXM-9</p> <p>FWHM 29.0°</p> <p>Efficiency 87 %</p> <p>Peak intensity 2.100 cd/lm</p> <p>Required components: F15255_HEKLA-SOCKET-C</p>		
<p><b>OSRAM</b> Opto Semiconductors</p> <p>LED Soleriq S9</p> <p>FWHM 28.0°</p> <p>Efficiency 90 %</p> <p>Peak intensity 2.400 cd/lm</p> <p>Required components: F15255_HEKLA-SOCKET-C C13723_MIRELLA-RZL</p>		



#### PHOTOMETRIC DATA (MEASURED):

#### SAMSUNG

LED LC010C G2  
FWHM 19.0°  
Efficiency 86 %  
Peak intensity 3.400 cd/lm  
Required components:  
F15255\_HEKLA-SOCKET-C

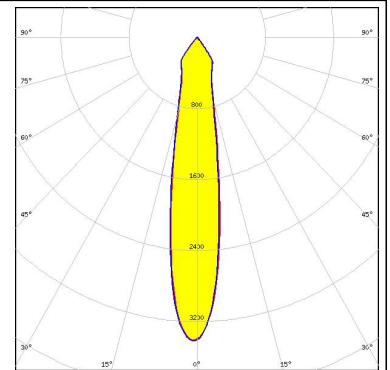

#### SAMSUNG

LED LC020C  
FWHM 25.0°  
Efficiency 88 %  
Peak intensity 2.500 cd/lm  
Required components:  
F15848\_HEKLA-SOCKET-G

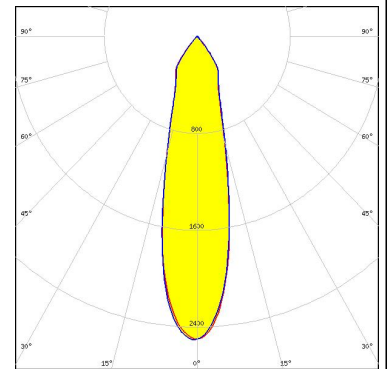

#### PHOTOMETRIC DATA (SIMULATED):

#### CITIZEN

LED CLL02x/CLU02x (LES10)  
FWHM 27.3°  
Efficiency 87 %  
Peak intensity 2.700 cd/lm  
Required components:  
F15255\_HEKLA-SOCKET-C

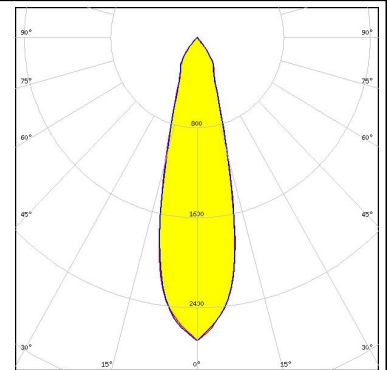

#### LUMILEDS

LED LUXEON M/MX  
FWHM 20.0°  
Efficiency 89 %  
Peak intensity 4.420 cd/lm  
Required components:  
F15255\_HEKLA-SOCKET-C

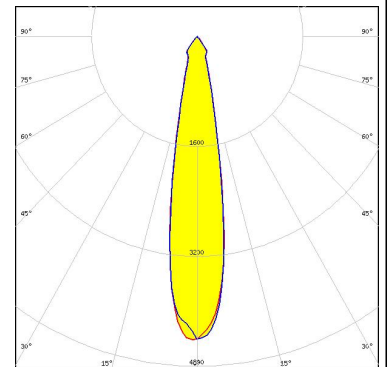

#### NICHIA

LED COB L-Type (LES 11)  
FWHM 32.0°  
Efficiency 88 %  
Peak intensity 2.130 cd/lm  
Required components:  
F15858\_HEKLA-SOCKET-H

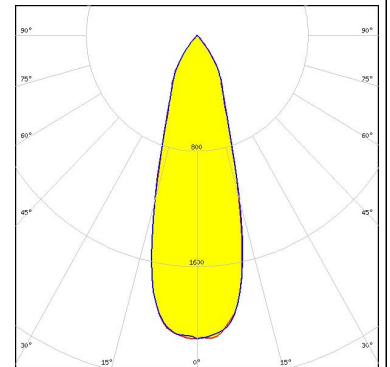

#### NICHIA

LED COB T-Type  
FWHM 21.0°  
Efficiency 88 %  
Peak intensity 3.970 cd/lm  
Required components:  
F15848\_HEKLA-SOCKET-G

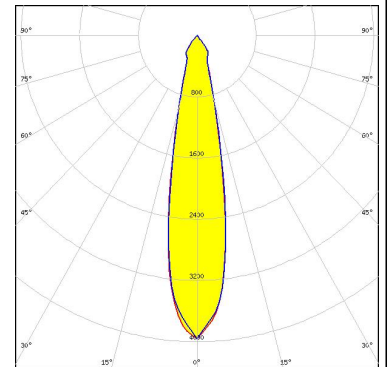

## PHOTOMETRIC DATA (SIMULATED):

### TRIDONIC

LED SLE G6 LES10

FWHM 26.0°

Efficiency 90 %

Peak intensity 3.000 cd/lm

Required components:

F15255\_HEKLA-SOCKET-C

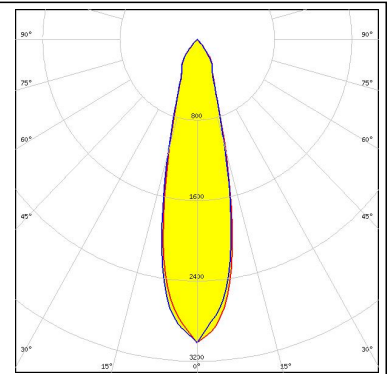

#### GENERAL INFORMATION:

NOTE: The typical beam angle will be changed by different color, chip size and chip position tolerance. The typical total beam angle is the full angle measured where the luminous intensity is half of the peak value.

Due to use of high power COB's with this product, special attention to proper thermal design is highly recommended. LEDiL has no liability for direct, indirect or consecutive damages arising from the LEDiL products being used outside of the recommended temperature range.

#### MATERIALS:

As part of our continuous research and improvement processes, and to ensure the best possible quality and availability of our products, LEDiL reserves the right to change material grades without notice.

#### PRODUCT DATA USER AGREEMENT AND DISCLAIMER:

The measured data in the provided downloadable LEDiL Product Datasheets and Mechanical 2D-Drawings is rounded and provided as reference for planning. LEDiL Oy's optical specifications have been verified by conducting performance testing of the products in accordance with the company's quality system. The reported data are averaged results of multiple measurements with typical variation. LEDiL Oy reserves the right to without prior notification make changes and improvements to its products.

LEDiL Oy assumes neither warranty, nor guarantee nor any other liability of any kind for the contents and correctness of the provided data. The provided data has been generated with highest diligence but the provided data may in reality not represent the complete possible variation range of all intrinsic parameters. Therefore, in certain cases a deviation from the provided data could occur.

LEDiL Oy reserves the right to undertake technical changes of its products without further notification which could lead to changes in the provided data. LEDiL Oy assumes no liability of any kind for the possible deviation from any provided data or any other damage resulting from the usage of the provided data.

The user agrees to this disclaimer and user agreement with the download or usage of the provided files.

#### LEDiL Oy

Joensuunkatu 13  
FI-24240 SALO  
Finland

#### LEDiL Inc.

228 West Page Street  
Suite D  
Sycamore IL 60178  
USA

#### Local sales and technical support

[www.ledil.com/where\\_to\\_buy](http://www.ledil.com/where_to_buy)

#### Shipping locations

Salo, Finland  
Hong Kong, China

#### Distribution Partners

[www.ledil.com/where\\_to\\_buy](http://www.ledil.com/where_to_buy)