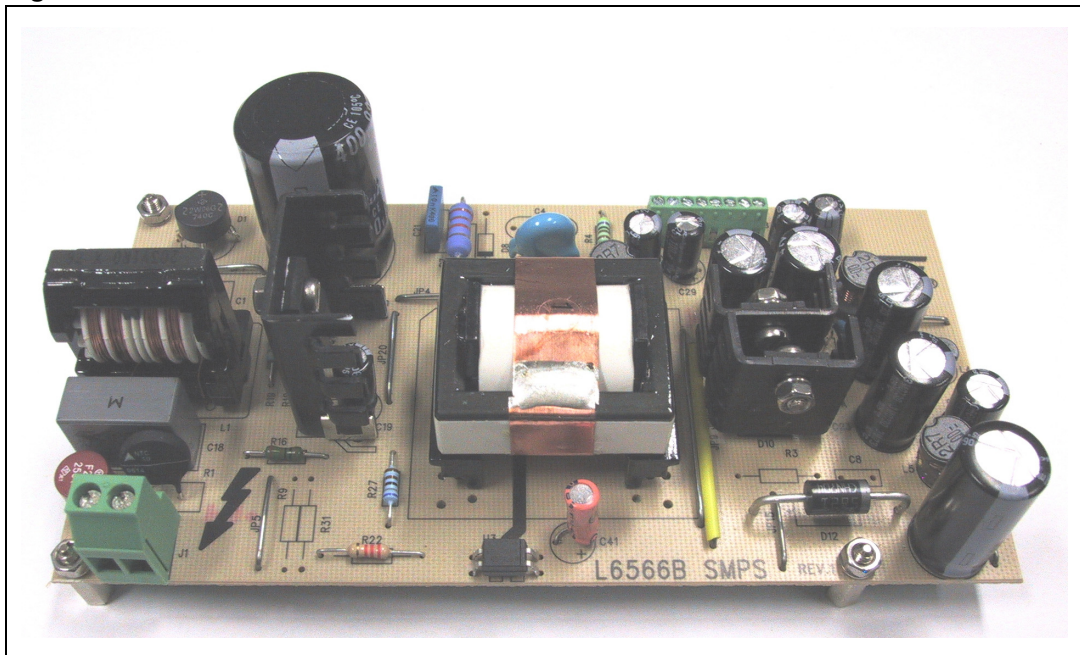


### 40 W wide input range flyback converter demonstration board for digital consumer equipment using the L6566B

#### Introduction

This document describes a demonstration board of a 40 W switch-mode power supply dedicated to set-top box, DVD and auxiliary SMPS for flat TVs or small size flat screen equipment. The board accepts a wide range of input voltages (90 to 265Vrms) and delivers 4 voltages. The design is based on the L6566B, a new current mode fixed frequency or QR controller. High efficiency and low standby consumption are the main characteristics of this board. These advantages, coupled with minimal part count required and low-cost approach of the global solution, make it a very interesting solution for powering digital consumer equipment, capable of meeting worldwide standby rules.

**Figure 1. EVL6566B-40WSTB demonstration board**



# Contents

<b>1</b>	<b>Main characteristics</b> .....	<b>4</b>
<b>2</b>	<b>Circuit description</b> .....	<b>6</b>
<b>3</b>	<b>Functional checking</b> .....	<b>9</b>
3.1	Full-load operation .....	9
3.2	Reduced load operation, without the HDD .....	11
3.3	Minimum load operation .....	12
3.4	Wakeup time and startup .....	16
3.5	Power down - hold-up time .....	18
3.6	Overload and overcurrent protection (OCP) .....	19
3.7	Overvoltage protection (OVP) .....	22
<b>4</b>	<b>Conducted noise measurements</b> .....	<b>23</b>
<b>5</b>	<b>Thermal measures</b> .....	<b>24</b>
<b>6</b>	<b>Bill of material</b> .....	<b>25</b>
<b>7</b>	<b>PCB layout</b> .....	<b>29</b>
<b>8</b>	<b>Transformer specifications</b> .....	<b>30</b>
<b>9</b>	<b>Conclusion</b> .....	<b>32</b>
9.1	References .....	32
<b>10</b>	<b>Revision history</b> .....	<b>33</b>

## List of figures

Figure 1.	EVL6566B-40WSTB demonstration board . . . . .	1
Figure 2.	Electrical diagram . . . . .	5
Figure 3.	EVL6566B-40WSTB waveforms at 115 Vac-60 Hz - full load . . . . .	9
Figure 4.	EVL6566B-40WSTB waveforms at 230 Vac-50 Hz - full load . . . . .	9
Figure 5.	EVL6566B-40WSTB waveforms at 265 V-50 Hz - full load . . . . .	10
Figure 6.	EVL6566B-40WSTB waveforms at 230 V - Pin=30 W . . . . .	13
Figure 7.	EVL6566B-40WSTB waveforms at 230 V - Pin=4 W . . . . .	13
Figure 8.	EVL6566B-40WSTB waveforms at 265 Vac - no load . . . . .	14
Figure 9.	EVL6566B-40WSTB waveforms at 265 Vac - no load (detail) . . . . .	14
Figure 10.	Input power vs. mains voltage during standby . . . . .	15
Figure 11.	Pin at 230 Vac vs. Iout 5 V . . . . .	15
Figure 12.	EVL6566B-40WSTB wakeup time at 115 Vac . . . . .	16
Figure 13.	EVL6566B-40WSTB wakeup time at 230 Vac . . . . .	16
Figure 14.	EVL6566B-40WSTB startup at 90 Vac - full load . . . . .	17
Figure 15.	EVL6566B-40WSTB startup at 265 Vac - full load . . . . .	17
Figure 16.	EVL6566B-40WSTB hold-up time at 115 Vac - full load . . . . .	18
Figure 17.	EVL6566B-40WSTB hold-up time at 230 Vac - full load . . . . .	18
Figure 18.	EVL6566B-40WSTB output short +12 V at 90 V- full load . . . . .	19
Figure 19.	EVL6566B-40WSTB output short +12 V at 265 V- full load . . . . .	19
Figure 20.	EVL6566B-40WSTB output short +1.8 V at 90 V- full load. . . . .	19
Figure 21.	EVL6566B-40WSTB output short +1.8 V at 265 V- full load. . . . .	19
Figure 22.	EVL6566B-40WSTB output short +5 V at 90 V - full load . . . . .	20
Figure 23.	EVL6566B-40WSTB output short +5 V at 265 V - full load. . . . .	20
Figure 24.	EVL6566B-40WSTB output short +3.3 V at 90 V - full load . . . . .	20
Figure 25.	EVL6566B-40WSTB output short +3.3 V at 265 V - full load . . . . .	20
Figure 26.	EVL6566B-40WSTB output short +12 V at 90 V- no load . . . . .	21
Figure 27.	EVL6566B-40WSTB output short +12 V at 265 V- no load . . . . .	21
Figure 28.	EVL6566B-40WSTB output short +1.8 V at 90 V- no load . . . . .	21
Figure 29.	EVL6566B-40WSTB output short +1.8 V at 265 V- no load . . . . .	21
Figure 30.	EVL6566B-40WSTB OVP at 230 Vac- full load . . . . .	22
Figure 31.	EVL6566B-40WSTB OVP at 230 Vac- no load . . . . .	22
Figure 32.	EVL6566B-40WSTB conducted noise measurement phase A without frequency jittering . . . . .	23
Figure 33.	EVL6566B-40WSTB conducted noise measurement phase A with frequency jittering . . . . .	23
Figure 34.	EVL6566B-40WSTB thermal map at 115 Vac - full load . . . . .	24
Figure 35.	EVL6566B-40WSTB thermal map at 230 Vac - full load . . . . .	24
Figure 36.	Silk screen - top side . . . . .	29
Figure 37.	Silk screen - bottom side . . . . .	29
Figure 38.	Transformer electrical diagram . . . . .	30
Figure 39.	Transformer winding diagram . . . . .	31

# 1 Main characteristics

The main characteristics of this SMPS are listed below:

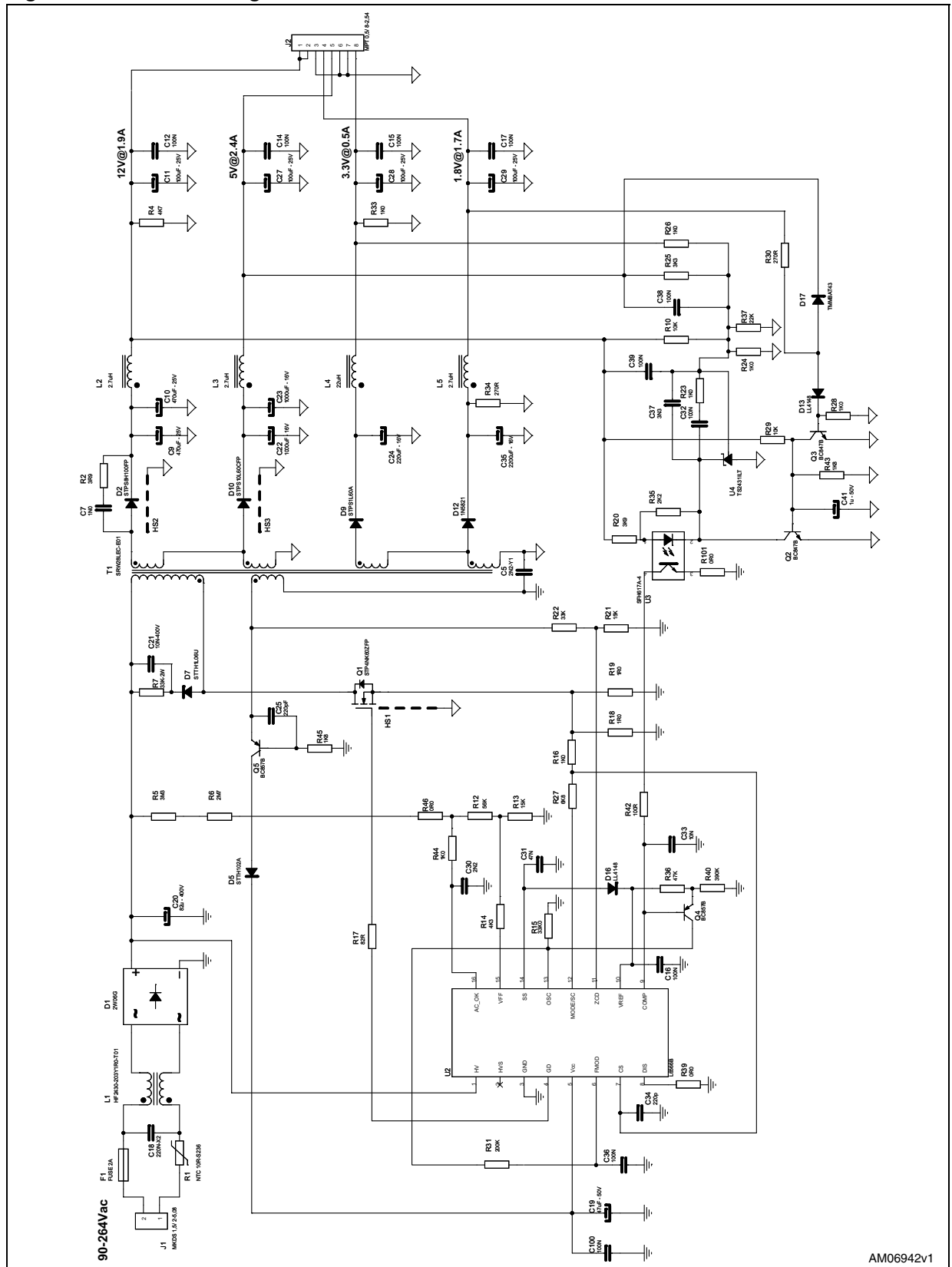
- Input voltage:  $V_{in}$ : 90 - 264 Vrms f: 45-66 Hz
- Output voltages as given in [Table 1](#)

**Table 1. Output voltages**

V <sub>out</sub>	I <sub>out</sub> MAX	I <sub>out</sub> MIN	P <sub>MAX</sub>	Stability	Notes
1.8 V	1.73 A	0.20 A	3.1 W	±7%	Dedicated to digital circuitry and to 1.2 V local post regulators
3.3 V	0.5 A	0.03 A	1.65 W	±5%	Dedicated to analog peripherals and 2.5 V regulators
5 V	2.4 A	0.3 A	12 W	±10%	Dedicated to HDD/DVD and 5 V circuitry
12 V	1.9 Avg 2.9 Apk	0.05 A	34.8 W	±8%	Dedicated to HDD/DVD, SCART and LNBP21 for satellite STB. Average load is 1.9 A, 2.9 A is dedicated to HDD/DVD spin-up
P <sub>OUT</sub> (W) = 40 W Avg / 51 W pk					

- Standby: better than 800 mW at 230 V<sub>in</sub>
- Short-circuit protection: on all outputs, with auto-restart at short removal
- PCB type and size: single-side 70 μm (2-Oz), CEM-1, 150 x 75 mm
- Safety: accordance with EN60065, creepage and clearance minimum distance 6.4 mm
- EMI: accordance with EN50022-Class B

Figure 2. Electrical diagram



## 2 Circuit description

The topology of this converter is the classical flyback, working in continuous and discontinuous conduction mode with fixed frequency, capable of achieving the best trade-off between the peak-to-rms current ratio and output capacitor size. The nominal switching frequency, 62 kHz, has been chosen to arrive at a compromise between the transformer size and the harmonics of the switching frequency, optimizing the input filter size and its cost. The input EMI filter is a classical Pi-filter, 1-cell for differential mode noise. An NTC (R1) limits the inrush current produced by the capacitor charging at plug-in. The MOSFET is a standard and inexpensive 600 V-2  $\Omega$  max, TO-220FP, needing just a small heat sink. The transformer is a layer type, using a standard ferrite type EER28L. It has been designed according to the EN60065 and it is manufactured by TDK. The reflected voltage is 70 V, providing enough room for the leakage inductance voltage spike with still margin for reliability of the MOSFET. The network D7, R7, C21 clamps the peak of the leakage inductance voltage spike.

The output rectifiers have been selected according to the maximum reverse voltage, forward-voltage drop and power dissipation. The rectifiers for 5 V and 12 V outputs are Schottky, low forward voltage drop type, hence dissipating less power with respect to standard types. They are housed in TO-220 package. A small heat sink for both devices is required, as indicated in the bill of material (BOM). The other two output rectifiers are Schottky too but with a smaller package. The snubber R2 and C7 damps the oscillation produced by the diode D2 at MOSFET turn-on. A small LC filter has been added on all outputs in order to filter the high frequency ripple without increasing the output capacitors and a capacitor (100 nF) has been placed on each output, to limit the spike amplitude.

The output voltage regulation is performed by secondary feedback sensing the 12 V, 5 V and 3.3 V outputs, while for 1.8 V output the regulation is achieved by the transformer coupling. The feedback network uses a TS2431 as error amplifier which drives an optocoupler SFH617A-4, insuring the required insulation between primary and secondary. The opto-transistor modulates directly the voltage on COMP pin of the L6566B.

The controller, the new L6566B, is an extremely versatile current mode primary controller embedding all functions needed to get very high performance power supplies. It also integrates all protections needed by a power supply offering a very high degree of flexibility to the designer.

Furthermore the L6566B has a soft-start (pin#14), disable (pin#8) and 5 V reference voltage VREF (pin#10) available.

### Startup sequence

The L6566B pin #1 (HV) is directly connected to the DC bulk voltage and at startup, an internal high voltage current source charges C19 and C100 until the L6566B turn-on voltage threshold is reached, then the high voltage current source is automatically switched off. As the L6566B starts switching it is initially supplied by the VCC capacitor, and then the transformer auxiliary winding provides the voltage to power the IC. Because the L6566B integrated HV startup circuit is turned off, it is not dissipative during normal operation and has a significant role to reduce the power consumption when the power supply operates at light load. This contributes significantly to meet worldwide standby standards currently required.

### Brownout protection

Brownout protection prevents the circuit from working with abnormal mains levels. It can be easily achieved using pin #16 (AC\_OK) of the L6566B. The divider R5, R6, R46, R12 and R13 is connected to the input DC bus and it is dedicated to sense the rectified input voltage peak value and feed it into the L6566B AC\_OK pin. An internal comparator then enables the IC operations if the mains level is correct, within the nominal limits. If the input voltage is below 85Vac, the startup of the circuit is inhibited, while the turnoff voltage has been set at the voltage reached by the bulk capacitor after the hold-up time. The internal comparator has in fact a current hysteresis allowing to set independently the L6566B turn-on and turnoff voltage.

### L6566B current mode control and voltage feed-forward function

R18 and R19 sense the MOSFET current and the signal is fed into pin #7 (CS), connected to the PWM comparator. This signal is thus compared with the COMP (pin #9) signal, which is coming from the optocoupler.

The maximum power that the converter can deliver is set by a comparator limiting the peak of the primary current, comparing the CS and an internal threshold (VCSX). If the current signal exceeds the threshold, the comparator limits the MOSFET duty cycle, hence the output power is also limited.

Because the maximum transferable power depends on both the primary peak current and the input voltage, in order to keep almost constant the overload set point that would change according to flyback input voltage, the L6566B implements a voltage feed-forward function via a dedicated pin. Hence, VCSX is modulated by the voltage on pin #15 (VFF) sensing the bulk voltage by a resistor divider. A higher voltage causes a smaller VCS, MAX so that the maximum power can be kept almost constant at any input voltage.

The resistor R27 connected between pin #7 (CS) and pin #12 (MODE/SC) provides the correct slope compensation to the current signal, required for the correct loop stability.

### L6566B short-circuit protection

In case of short-circuit, an internal comparator senses the COMP pin after the soft-start time. In that condition the COMP pin goes high, activating an internal current source that restarts charging the soft-start capacitor from the initial 2 V level. If the voltage on this pin reaches 5 V, the L6566B stops the operation and enters in "hiccup mode". The L6566B restarts with a startup sequence when the Vcc voltage drops below the Vcc restart level (5 V). Because of the long time needed by the Vcc capacitor to drop to 5 V, this results in an increase of the duration of the no-load operation, thus decreasing the power dissipation and the stress of the power components. This sequence is repeated until the short is removed, after that the normal operation of the converter is automatically resumed.

Another comparator having its threshold at 1.5 V dedicated to protecting the circuit in case of transformer saturation or secondary diodes short is provided too. If the voltage on the CS pin (#7) exceeds this threshold two consecutive times, the IC immediately shuts down and latches off. This is intended to prevent spurious activation of the protection in case of temporary disturbances, for example during the immunity tests. Even in this case the IC operation is resumed as soon as the Vcc voltage drops below 5 V. In this way a hiccup mode operation is still obtained, avoiding consequent failures due to overheating of the power components. The sequence described here effectively protects the circuit if during the short operation the power supply delivers a significant high power at the output. Sometimes, in multi-output SMPS in case of short on a low voltage output and especially when the power supply is not delivering the full load, the power delivered to the shorted output could be



lower than the total maximum deliverable output power of the power supply. In that case the situation would be critical because the power supply is delivering a high output current that could overheat the secondary side components, but the reduced power at primary side would not be able to trigger the overload protection at primary side. Therefore, an output voltage sensing on the lower voltage is implemented. Thus, in case a low voltage output is shorted, the abnormal lower value of that output is detected and the COMP pin is tied to GND by Q2 and Q3, pushing the circuit to work in hiccup mode.

### Overvoltage protection

The pin #11 (ZCD) is connected to the auxiliary winding by a resistor divider. It implements the OVP against feedback network failures. When the ZCD pin voltage exceeds 5 V, the IC is shut down. This protection can be set as latch or auto-restart by the user with no additional components. On the board it is set as latched. Therefore the operations can be resumed after a mains recycling.

### Standby power saving and light-load frequency foldback function

The L6566B implements a current mode control, thus it monitors the output power by pin COMP, which level is proportional to the load. Thus, when the voltage on pin COMP falls below an internal threshold, the controller is disabled and its consumption reduced; Normal operation restarts as soon as the COMP voltage rises again. In this way a low consumption burst mode operation is obtained.

The burst mode feature is dedicated to reduce the no load consumption but another target of this application is achieving a high converter efficiency even at light load, when normally it is quite low. To improve the efficiency at this load condition a reduction of the switching frequency is needed, in order to save AC and transition losses of the power section. A simple circuit realizing a frequency foldback, connected to the L6566B oscillator (pin #13 - OSC) is implemented on the board. This solution allows improving light-load efficiency requiring just three external components.

### Frequency jittering

To improve the EMI behavior of the application and make it quieter thus minimizing the EMI filter, the L6566B is provided with a dedicated pin, FMOD (#6), allowing the user the possibility to modulate the oscillator frequency in case the device is set for working in fixed frequency mode. The FMOD pin (#6) gives the possibility to select both the modulation frequency and the modulation depth. On the board, the capacitor C36 connected from this pin to GND is alternately charged and discharged by internal current sources. As a result, the voltage on the pin is a symmetrical triangular waveform with the frequency related to its value. By connecting a resistor (R31) from this pin to pin OSC (#13) it is possible to modulate the current sourced by the OSC pin and then the switching frequency. In this board a 400 Hz modulating frequency and  $\pm 5$  kHz of frequency deviation have been set. The modulation reduces the peak value of EMI emissions by means of a spread-spectrum action. Please refer to [Chapter 4: Conducted noise measurements on page 23](#) for the relevant measurements and comparison of the circuit working with or without the frequency jittering function.

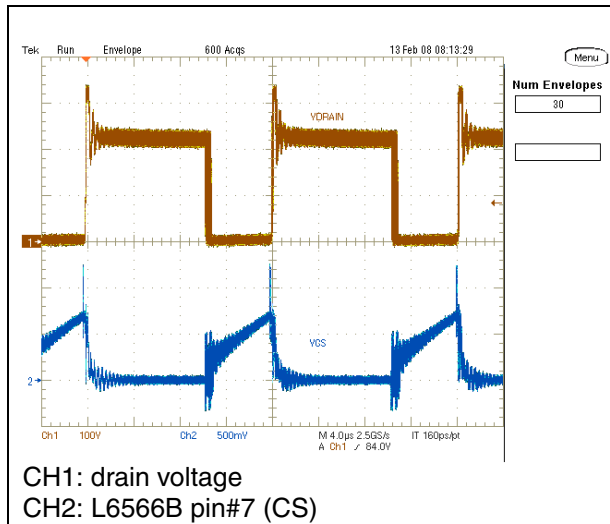


## 3 Functional checking

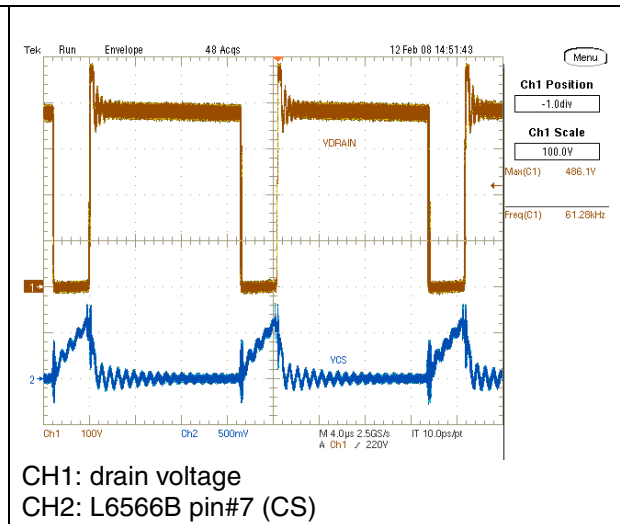
### 3.1 Full-load operation

The following waveforms during normal operation at full load at different input voltages are shown for user reference:

**Figure 3. EVL6566B-40WSTB waveforms at 115 Vac-60 Hz - full load**

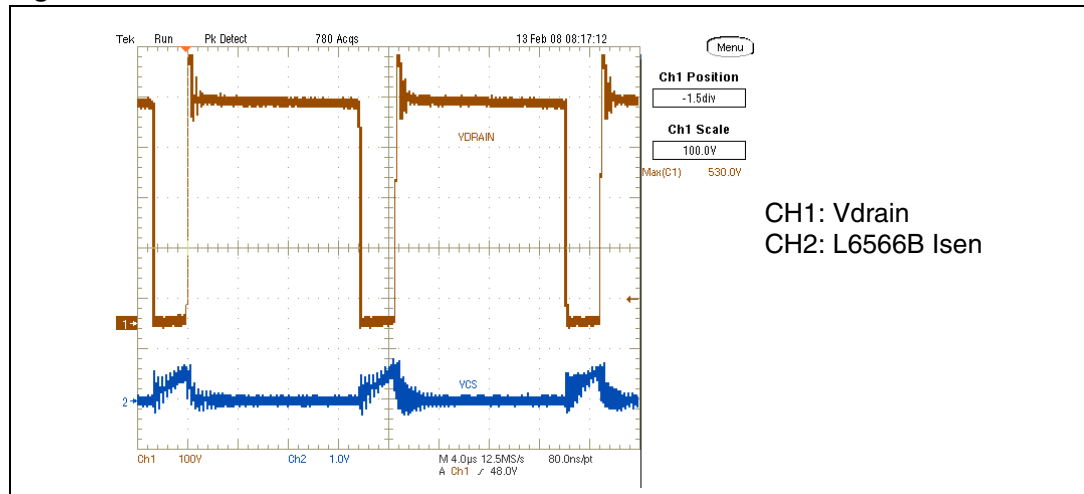


**Figure 4. EVL6566B-40WSTB waveforms at 230 Vac-50 Hz - full load**



*Figure 3* shows the drain voltage and current waveforms at 115 Vac while in *Figure 4* the waveforms are taken at 230 Vac. From the drain waveform it is possible to note that the transformer is working in continuous mode. This operating mode has been chosen in order to optimize the output filter capacitors and the peak-to-rms ratio of the current flowing in the transformer windings. The measured switching frequency is 61 kHz. In *Figure 5*, the drain voltage peak at full load and maximum input mains voltage has been measured. The maximum voltage peak in this condition is 530 V, ensuring a reliable operation of the MOSFET with good margin against its maximum  $BV_{DSS}$ .

Figure 5. EVL6566B-40WSTB waveforms at 265 V-50 Hz - full load



The following table shows the output voltage measurements and the overall efficiency of the converter measured at nominal input mains voltages. All output voltages have been measured on the output connector of the board.

Table 2. EVL6566B-STB-40W efficiency measurement at full load

Vin = 115 Vac-60 Hz			Vin = 230 Vac-50 Hz		
Voltage [V]	Current [A]	Deviation	Voltage [V]	Current [A]	Deviation
11.94	1.9	-0.50%	11.82	1.9	-1.50%
1.77	1.7	-1.67%	1.79	1.7	-0.56%
4.89	2.4	-2.20%	4.89	2.4	-2.20%
3.33	0.5	0.91%	3.33	0.5	0.91%
Pout [W] = 39.10			Pout [W] = 38.9		
Pin [W] = 50.6			Pin [W] = 48.95		
Efficiency =77.26 %			Efficiency =79.47 %		

In [Table 2](#) it is possible to note that all voltages are within the tolerance given in the specification. The efficiency measured is very good for this kind of SMPS, thanks to the absence of post regulators.

In the following [Table 3](#) the output voltages are measured during the spin-up of the HDD or the DVD, meaning a temporary increasing of the 12 V output current supplying the motor. The other output voltage loads are unchanged.

**Table 3. EVL6566B-STB-40W efficiency measurement at HDD spin-up**

Vin = 115 Vac-60 Hz			Vin = 230 Vac-50 Hz		
Voltage [V]	Current [A]	Deviation	Voltage [V]	Current [A]	Deviation
11.75	2.9	-2.08%	11.66	2.9	-2.83%
1.77	1.7	-1.67%	1.79	1.7	-0.56%
4.83	2.4	-3.40%	4.85	2.4	-3.00%
3.35	0.5	1.52%	3.35	0.5	1.52%
Pout [W] =	50.35		Pout [W] =	50.17	
Pin [W] =	66.4		Pin [W] =	62.94	
Efficiency =	75.83 %		Efficiency =	79.71 %	

As observable in this table, the output voltages are still within the given tolerance. The heavier load does not affect efficiency. Please note that the total output power of [Table 3](#) is the so-called "electrical power", not the "thermal power". Therefore, the circuit has been designed to deliver the "electrical power" for a short time only - typically the HDD spin-up has duration of 1 second - but it cannot be delivered significantly longer because, from the thermal point of view, the circuit can manage with the required reliability the full load only.

### 3.2 Reduced load operation, without the HDD

This reference board has been designed for powering digital equipment including a hard disk drive or a DVD but it can be used even for powering a set-top box or any other digital equipment without the hard disk drive. A typical example could be an auxiliary SMPS of a large screen flat-TV. The measurements shown in [Table 4](#) provide for the output voltage and efficiency measurements in a load condition typical of a satellite set-top box.

The 12 V and 5 V output currents have been reduced with respect to the previous measurements. As visible the output voltages are within the tolerances and the efficiency is at the same level of the previous test results.

**Table 4. Output voltage measurement at reduced load, without HDD**

Vin = 115 Vac-60 Hz			Vin = 230 Vac-50 Hz		
Voltage	Current	Deviation	Voltage	Current	Deviation
12.08	1.1	0.67%	12.09	1.1	0.75%
1.76	1.7	-2.22%	1.78	1.7	-1.11%
4.99	1.8	-0.20%	4.99	1.8	-0.20%
3.30	0.5	0.00%	3.3	0.5	0.00%
Pout [W] =	26.91		Pout [W] =	26.96	
Pin [W] =	34.5		Pin [W] =	33.9	
Efficiency =	78.01%		Efficiency =	79.52%	

### 3.3 Minimum load operation

Even at minimum load the power supply is still capable of regulating the output voltages within the specification tolerances, as indicated by the measurements in [Table 5](#). The efficiency is still high.

**Table 5. Output voltage measurement at reduced load, without HDD**

Vin = 115 Vac-60 Hz			Vin = 230 Vac-50 Hz		
Voltage [V]	Current [A]	Deviation	Voltage [V]	Current [A]	Deviation
11.97	0.05	-0.25%	11.99	0.05	-0.08%
1.78	0.2	-1.11%	1.79	0.2	-0.56%
4.89	0.3	-2.20%	4.89	0.3	-2.20%
3.40	0.03	3.03%	3.40	0.03	3.03%
Pout [W] =	2.52		Pout [W] =	2.53	
Pin [W] =	3.43		Pin [W] =	3.69	
Efficiency =	73.57 %		Efficiency =	68.47%	

Future new regulations and voluntary agreements for consumer and information technology equipment require that power supplies and adapters have high efficiency not only at nominal or maximum load but also at minimum and light load. In these conditions most of the time good efficiency is a difficult task to achieve, as it increases the complexity of control. By just adding a few external components, the oscillator structure of the L6566B can very easily implement a frequency foldback. Thus, the frequency reduction minimizes the switching losses, improving the power supply efficiency when it is working with an input power in the range of 1 to 30 W.

The L6566B switching frequency is set by the current flowing in a resistor connected between the OSC pin and ground (R15). During light-load operation the COMP (pin#9) level decreases and Q4 injects into R15 and OSC (pin #13) a current inversely proportional to the COMP voltage. Because the voltage on pin OSC is constant (1 V), increasing Q4 current provides for the decrease of the current supplied by the pin and, as a consequence, the oscillator frequency. Thus, a frequency reduction proportional to the output load is easily obtained.

[Figure 6](#) and [7](#) show the waveforms at different input power consumption. It can be noted that the switching frequency is lower than the value measured at full load and decreases proportionally to the COMP pin level.

Figure 6. EVL6566B-40WSTB waveforms at 230 V - Pin=30 W

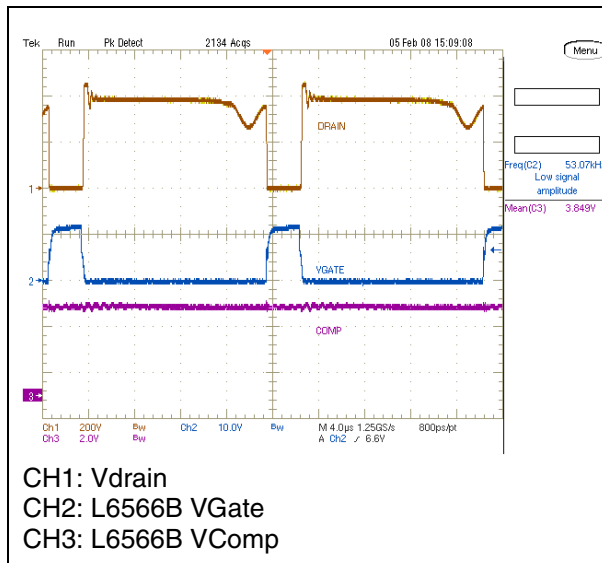
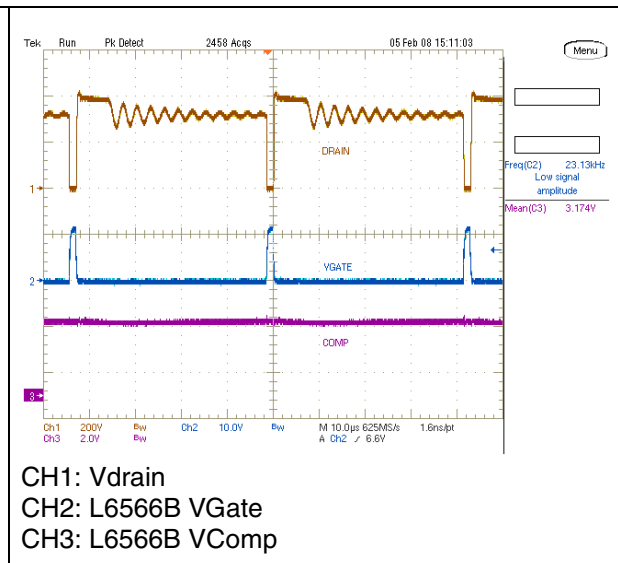


Figure 7. EVL6566B-40WSTB waveforms at 230 V - Pin=4 W



If the load is further decreased, the L6566B works in burst mode. Once the COMP (pin#9) voltage drops below the internal threshold, the L6566B stops the gate driver operation decreasing the internal circuitry consumption to minimize C19 discharging. Once the comp voltage rises above the internal burst mode threshold the device restarts switching. In [Figure 8](#) and [9](#) the burst-mode waveforms are shown. The pictures are taken at 265 V because at no-load condition the auxiliary voltage powering the L6566B falls at input mains increasing. This very often causes the supply voltage  $V_{cc}$  of the control IC to drop below the UVLO threshold so that the operation becomes intermittent, which is undesired. Furthermore, this must be traded off against the need of generating a voltage not exceeding the maximum allowed by the control IC at full load to avoid overstress to the internal  $V_{cc}$  pin clamping circuitry and consequent overheating of the controller.

To overcome this problem, the device, besides reducing its own consumption during burst-mode operation, also features a proprietary adaptive UVLO function. It consists of shifting the UVLO threshold downwards at light load, namely when the voltage at pin COMP falls below a threshold  $V_{COMPO}$  internally fixed, so as to have a greater margin. To prevent any malfunction during transients from minimum to maximum load the normal (higher) UVLO threshold is re-established when the voltage at pin COMP exceeds  $V_{COMPL}$  and  $V_{cc}$  has exceeded the normal UVLO threshold. The normal UVLO threshold ensures that at full load the MOSFET is driven with a proper gate-to-source voltage. As visible in [Figure 9](#) the  $V_{cc}$  is measured showing that there is a good margin with respect to the maximum turnoff threshold (8 V maximum) of the L6566B.

Figure 8. EVL6566B-40WSTB waveforms at 265 Vac - no load

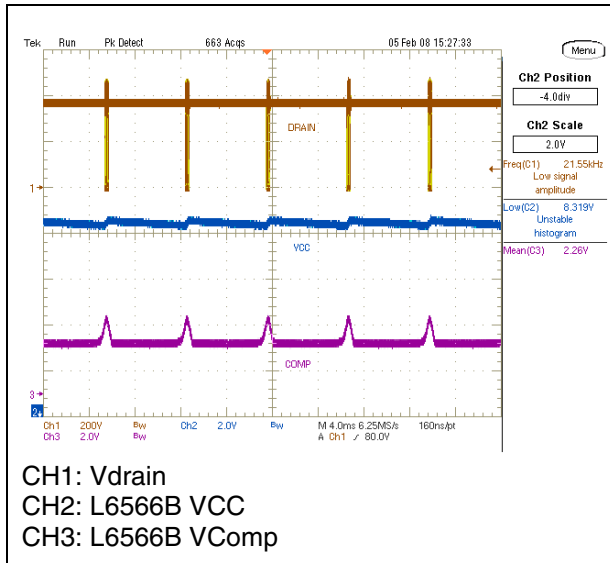
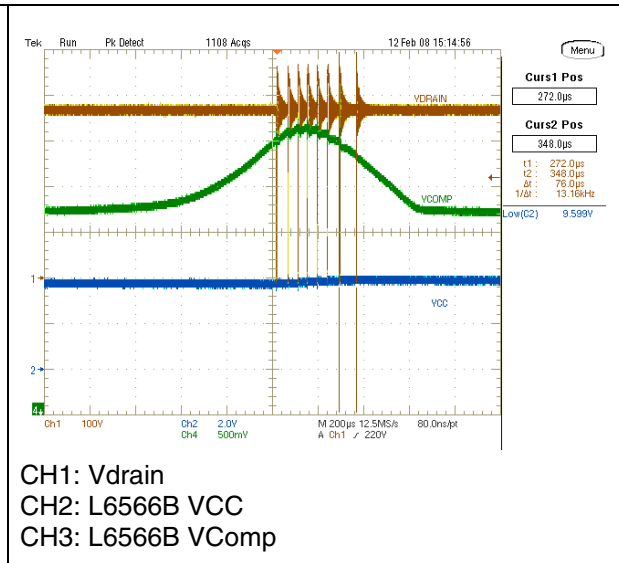


Figure 9. EVL6566B-40WSTB waveforms at 265 Vac - no load (detail)



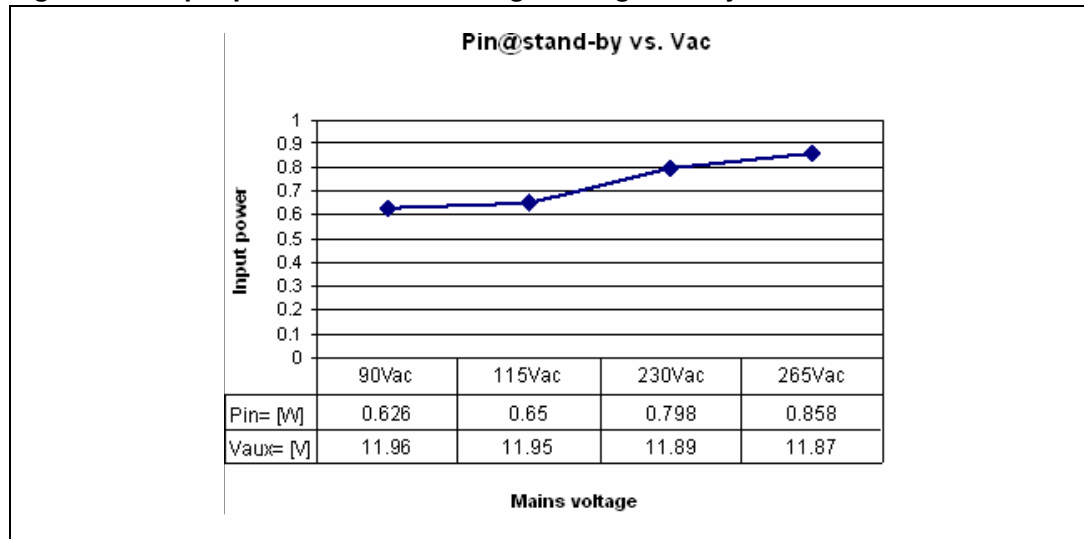
In [Table 6](#) the standby consumption is measured at both input mains voltages. Even in this load condition the circuit is able to regulate the output voltages within the required tolerance. The input power is also measured. While delivering the standby load (5 V at 50 mA, 1.8 V, 3.3 V and 12 V at 0 mA), the input power consumption is lower than 800 mW at both nominal input voltage ranges.

Table 6. Measurements during standby operation

Vin = 115 Vac-60 Hz			Vin = 230 Vac-50 Hz		
Voltage [V]	Current [A]	Deviation	Voltage [V]	Current [A]	Deviation
11.71	0	-2.42%	11.75	0	-2.08%
1.91	0	6.11%	1.90	0	5.56%
4.83	0.05	-3.40%	4.87	0.05	-2.60%
3.44	0	4.24%	3.44	0	4.24%
Pout [W] =	0.24		Pout [W] =	0.24	
Pin [W] =	0.648		Pin [W] =	0.798	
Efficiency =	37.27%		Efficiency =	30.51%	

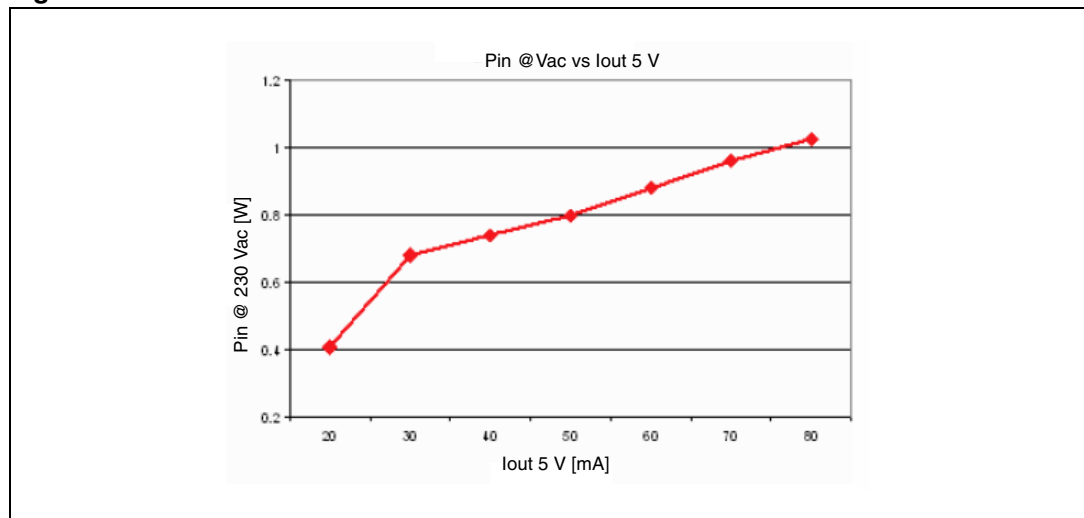
In [Figure 10](#), the input power consumption over the input voltage range is shown. As visible there is just a small increase of the input power when the circuit is working close to the maximum input voltage.

Figure 10. Input power vs. mains voltage during standby



The diagram in the following [Figure 11](#) represents the input power consumption as a function of the 5 V output current. All other output voltages have no load as in the previous measurements. It is clearly visible that by decreasing the output current, the input power at 230 Vac still decreases, keeping good efficiency of the circuit.

Figure 11. Pin at 230 Vac vs. Iout 5 V



Even if consumer applications such as set-top boxes or DVDs and digital equipment generally always have a residual consumption in standby, the board is also capable of working without any load. In the following [Table 7](#) the output voltage and power consumptions measurements during no-load operation are given.

As shown in the table the no-load consumption, thanks to L6566B functionalities, is very low at both nominal input voltage mains.



**Table 7. EVL6566B-STB-40W efficiency measurement at no load**

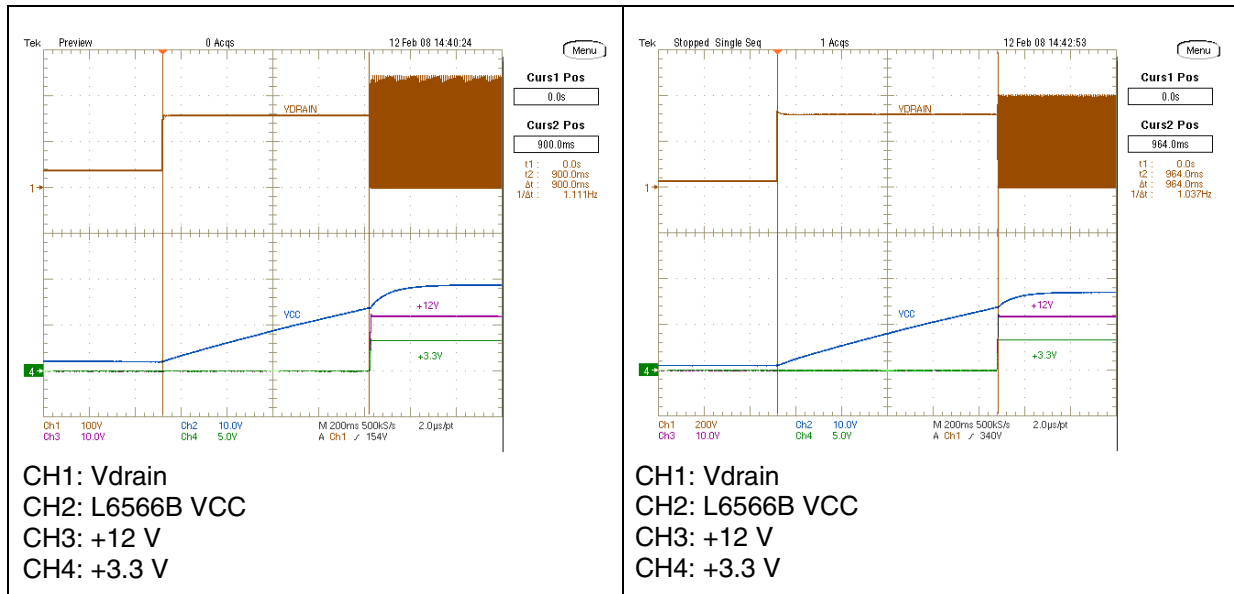
115 Vac-60 Hz			230 Vac-50 Hz		
Voltage [V]	Current [A]	Dev.[%]	Voltage [V]	Current [A]	Dev.[%]
12.05	0	0.42%	12.06	0	0.50%
1.83	0	1.67%	1.83	0	1.67%
5.24	0	4.80%	5.25	0	5.00%
3.30	0	0.00%	3.29	0	-0.30%
Pin [W]:	0.180		Pin [W]:	0.240	

### 3.4 Wakeup time and startup

Figure 12 and 13 show waveforms with the wakeup time measurements at both nominal input mains. The measured wakeup time at 115 Vac and 230 Vac is around 900 milliseconds, which is a common value for this kind of power supply. Thus, thanks to high voltage circuitry integrated in the L6566B, the wakeup time is constant over the input voltage range.

**Figure 12. EVL6566B-40WSTB wakeup time at 115 Vac**

**Figure 13. EVL6566B-40WSTB wakeup time at 230 Vac**

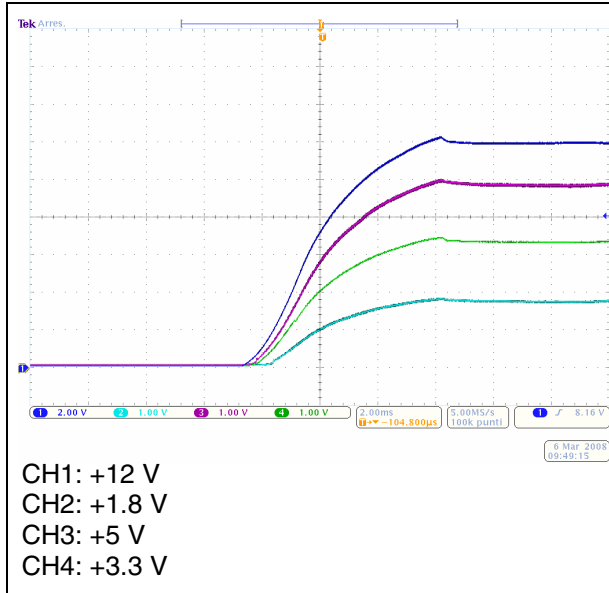


As visible in Figure 12 and 13 captured at the nominal mains voltages, overshoot, undershoot, dip or abnormal behavior is not present during the initial working phase of the power supply. The power supply has been checked over the input voltage range with same positive results as shown in the above figures.

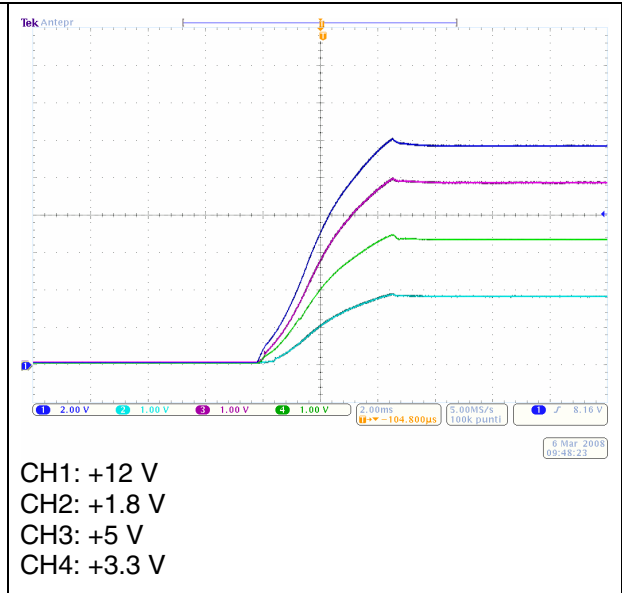
Figure 14 and 15 show the rising slope of output voltages. As visible in the pictures, the rising times are constant and there is no difference between the rise times of the output voltages. Just a negligible overshoot is present in full-load conditions, without consequences

for the supplied circuitry. To avoid problems at startup, this characteristic is quite important when the load includes a microprocessor and its peripherals, as in this case.

**Figure 14. EVL6566B-40WSTB startup at 90 Vac - full load**



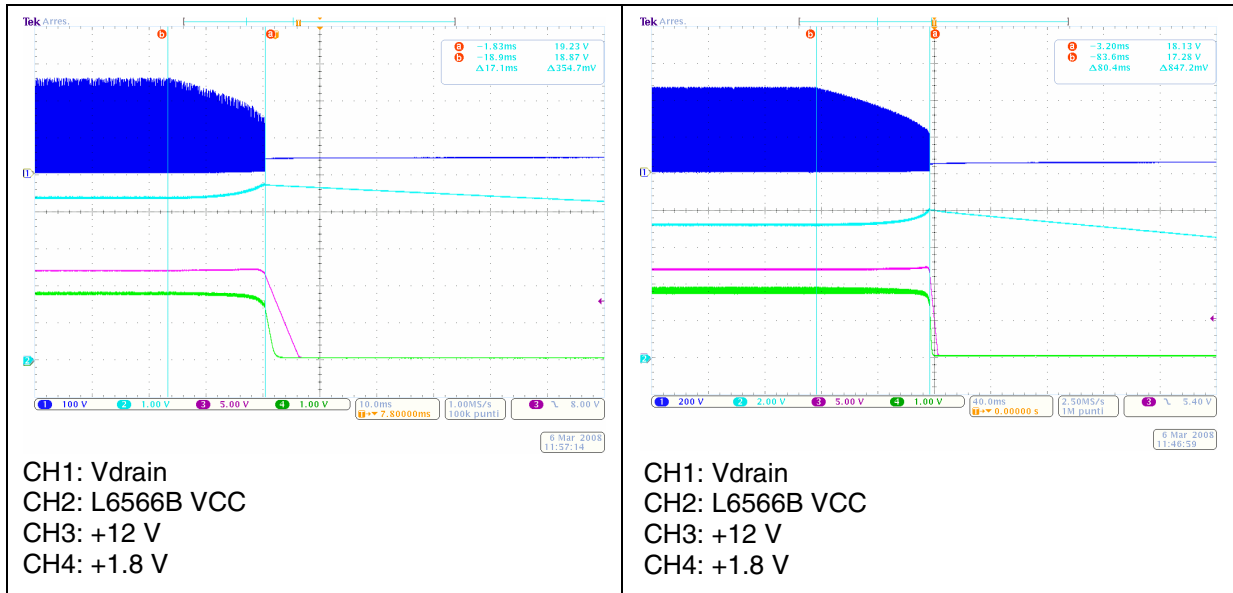
**Figure 15. EVL6566B-40WSTB startup at 265 Vac - full load**



### 3.5 Power down - hold-up time

Even at turn-off the transition is clean, without any abnormal behavior such as restart attempts or glitches on both the auxiliary and the output voltages. In [Figure 16](#) and [17](#) the hold-up time is also measured at both nominal mains voltages. At 115 Vac (155 Vdc) the input capacitor (C20) stores enough energy for keeping the regulation for 17.1 mS at full load, after that the converter loses regulation and the output voltages drop.

**Figure 16. EVL6566B-40WSTB hold-up time at 115 Vac - full load**      **Figure 17. EVL6566B-40WSTB hold-up time at 230 Vac - full load**



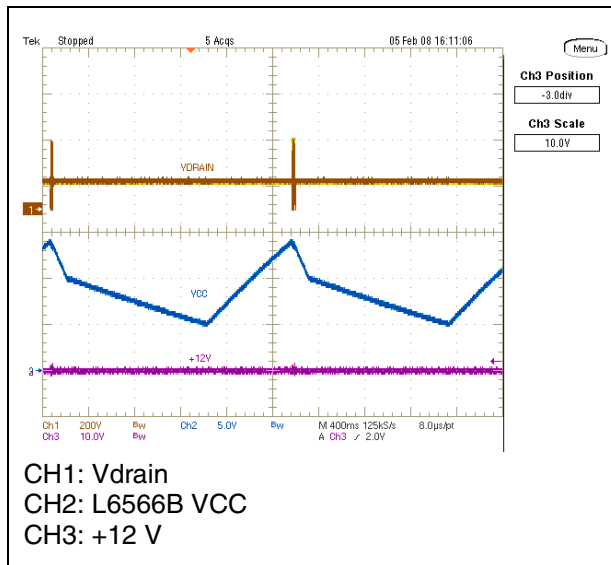
The measured time is adequate to provide immunity of the set-top box against standard mains dip or short interruptions tests, required by standard rules such as the IEC1000, and protects the unit against loss of channel tuning or video disturbances while the end user is watching TV or recording programs.

### 3.6 Overload and overcurrent protection (OCP)

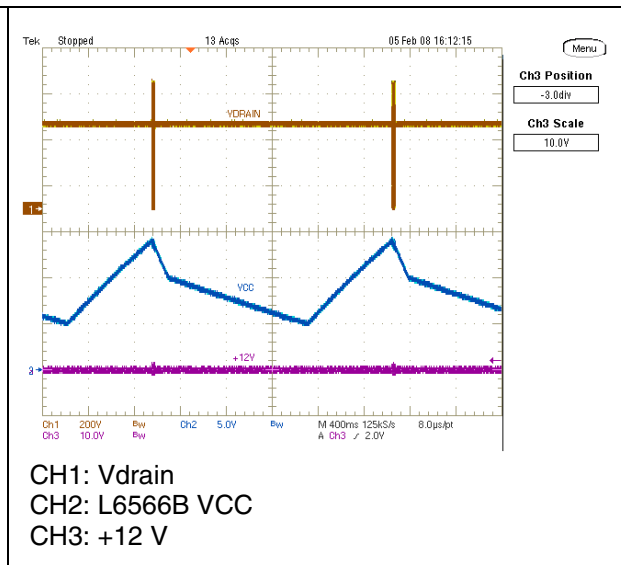
An important functionality of any power supply is the capability to survive in case of load short-circuit and to avoid any consequent failure. Additionally, the power supply must be compliant with safety rules, requiring that, in case of fault, no component melts or burns out.

The board has been tested over the input voltage mains range and in all load conditions. As indicated by the waveforms from *Figure 18* to *Figure 29*, as soon an output is shorted, the circuit begins to work in hiccup mode, keeping the mean value of the current at levels sustainable by the component rating. The auto-restart at short removal is correct in all conditions.

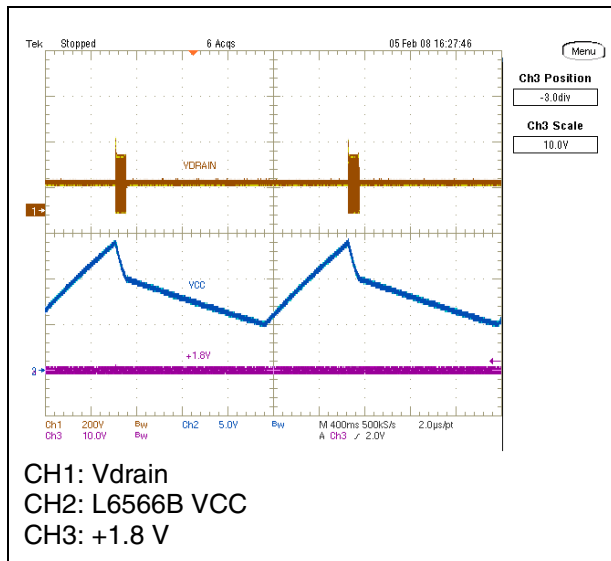
**Figure 18. EVL6566B-40WSTB output short +12 V at 90 V- full load**



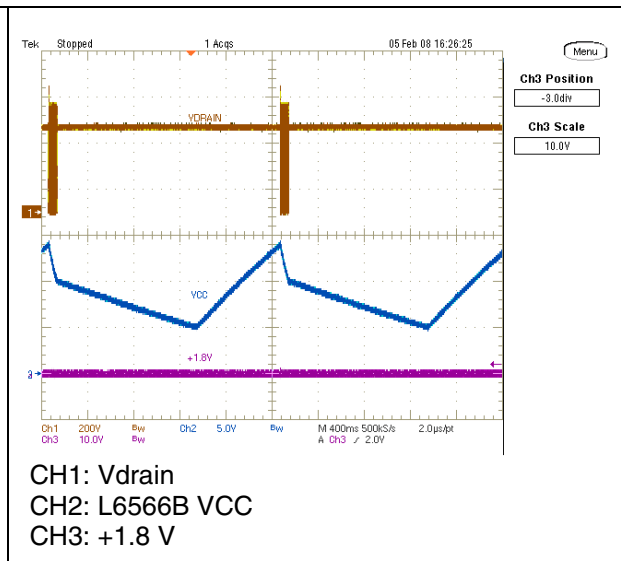
**Figure 19. EVL6566B-40WSTB output short +12 V at 265 V- full load**



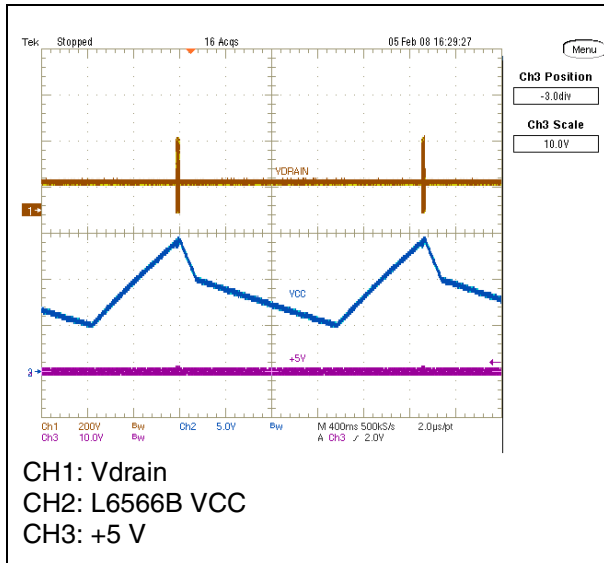
**Figure 20. EVL6566B-40WSTB output short +1.8 V at 90 V- full load**



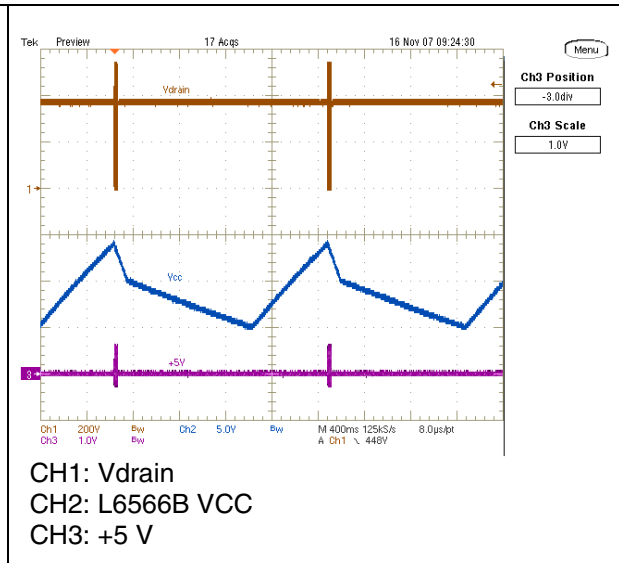
**Figure 21. EVL6566B-40WSTB output short +1.8 V at 265 V- full load**



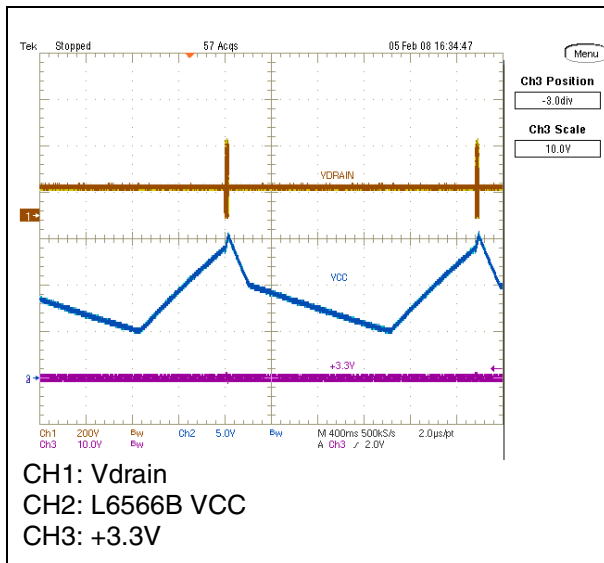
**Figure 22. EVL6566B-40WSTB output short +5 V at 90 V - full load**



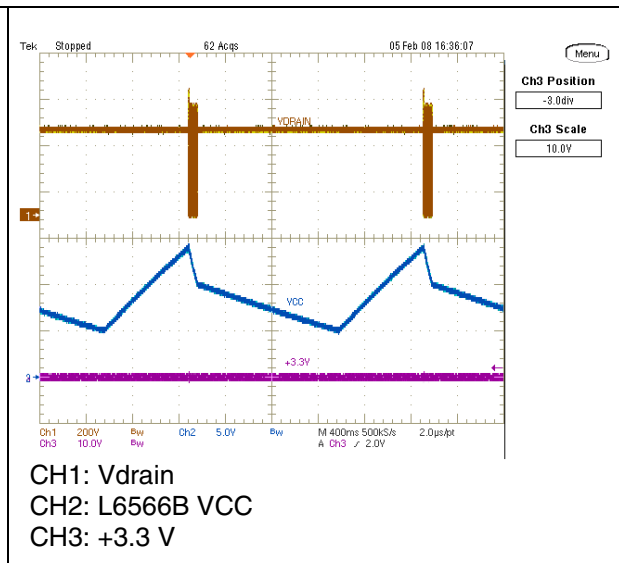
**Figure 23. EVL6566B-40WSTB output short +5 V at 265 V - full load**



**Figure 24. EVL6566B-40WSTB output short +3.3 V at 90 V - full load**

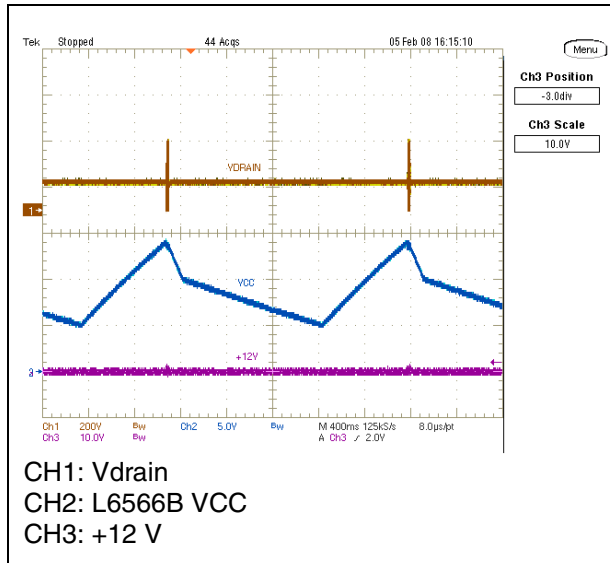


**Figure 25. EVL6566B-40WSTB output short +3.3 V at 265 V - full load**

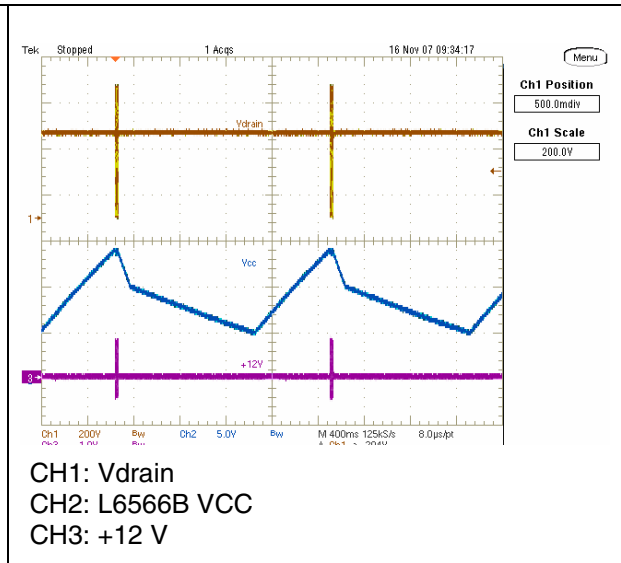


Even the 1.8 V output is well protected against shorts as highlighted in the pictures. Because the coupling between the 1.8 V and the auxiliary winding is poor, to help the circuit enter in burst mode the circuitry based on Q2 and Q3 has been added. This circuit senses the 1.8 V and drives the circuit to work in hiccup mode if this voltage disappears. Thus all output voltages are protected against shorts in all line and load conditions.

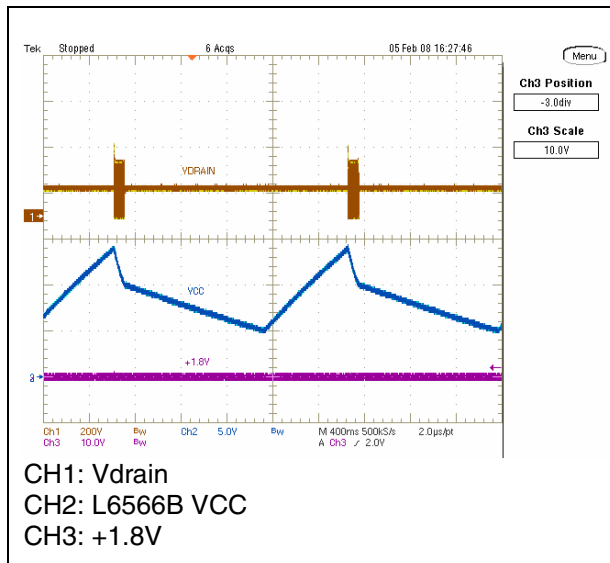
**Figure 26. EVL6566B-40WSTB output short +12 V at 90 V- no load**



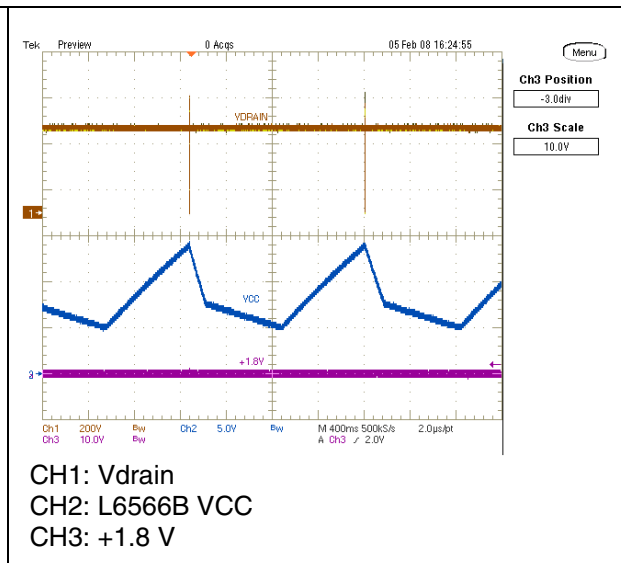
**Figure 27. EVL6566B-40WSTB output short +12 V at 265 V- no load**



**Figure 28. EVL6566B-40WSTB output short +1.8 V at 90 V- no load**



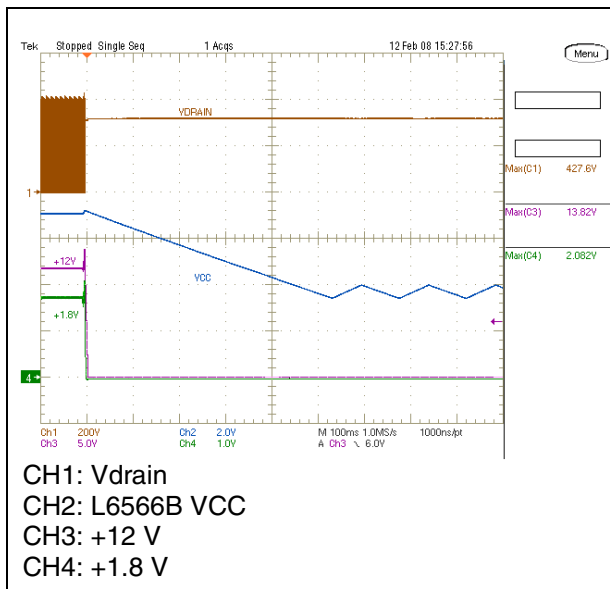
**Figure 29. EVL6566B-40WSTB output short +1.8 V at 265 V- no load**



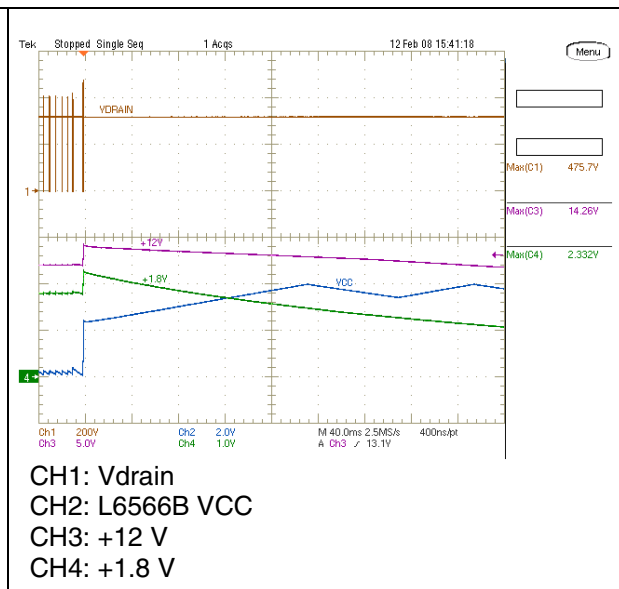
### 3.7 Overvoltage protection (OVP)

A protection that any power supply must have is that against the failure of the feedback circuitry. If this occurs, the SMPS output voltages can rise to high values, depending on the load on each output and the transformer coupling between the windings. To avoid this kind of failure an innovative protection has been integrated in the L6566B sensing the auxiliary winding voltage. This signal is connected to the L6566B at the ZCD (pin#11) through a simple divider setting the threshold level. Once the ZCD pin voltage becomes higher than the 5 V internal threshold, the IC is latched. This feature properly protects the power supply from OVP and stops the operation from decreasing consumption at a low value. The status is latched until Vcc falls below the UVLO threshold. To remain in the latched status the L6566B internal HV generator is activated periodically so that Vcc oscillates between the startup threshold VccON and VccON - 0.5 V. The SMPS can restart after the disconnection of the converter from the mains and the Vcc pin decreases below the UVLO threshold. In [Figure 30](#) and [31](#), the circuit behavior is shown as described above at full-load and no-load conditions. The maximum voltage values on each output are also shown and as visible there is just a slight variation between the two load conditions.

**Figure 30. EVL6566B-40WSTB OVP at 230 Vac- full load**



**Figure 31. EVL6566B-40WSTB OVP at 230 Vac- no load**

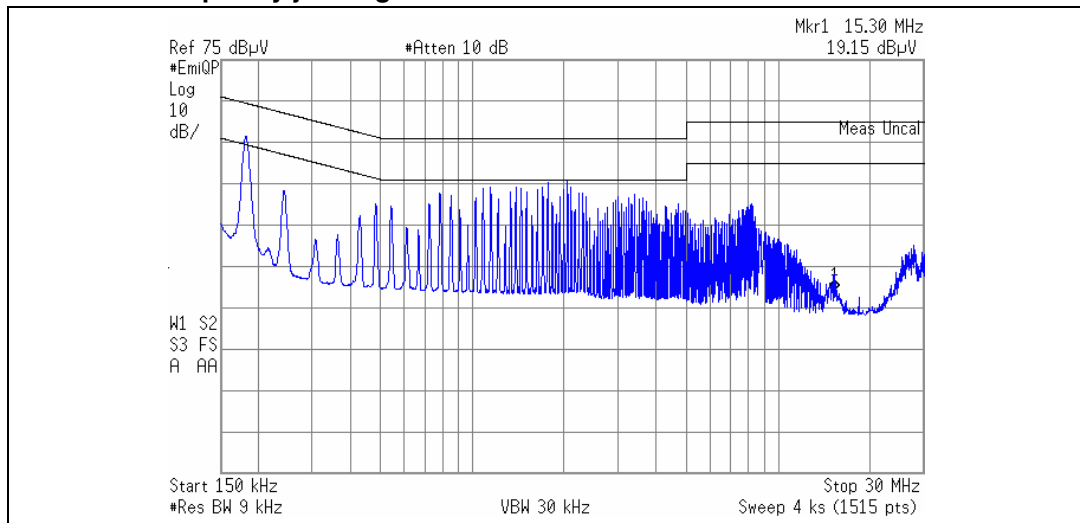




## 4 Conducted noise measurements

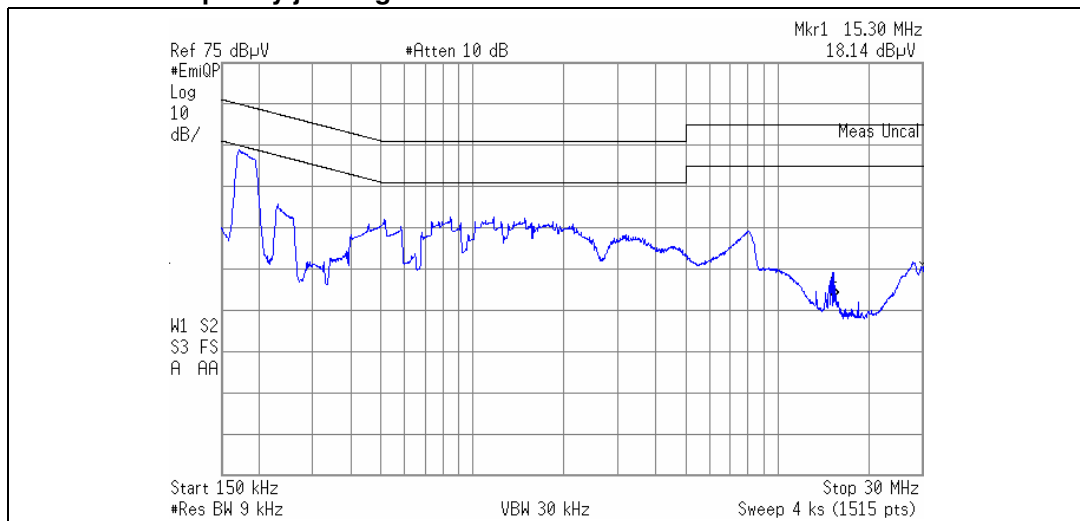
The following pictures are the conducted noise measurements at full load and 230 Vac mains voltage, taken on phase wire with quasi peak detection. [Figure 32](#) shows the measurement without frequency jittering. The limits shown on the diagrams are EN55022 CLASS B, which is the most common rule for video domestic equipment, such as a set-top box. As visible on the diagram there is a good margin of the measures with respect to the QP limits but the measurement exceeds the average measurement limit.

**Figure 32. EVL6566B-40WSTB conducted noise measurement phase A without frequency jittering**



[Figure 33](#) shows the same application board implementing frequency modulation. The reduction of noise peak obtained using the FMOD pin function is clearly visible. Just by adding a resistor and a capacitor, a 400 Hz modulating frequency and  $\pm 5$  kHz of switching frequency variation is applied. The conducted noise has been measured in all conditions at different mains voltages on both mains wires with similar results.

**Figure 33. EVL6566B-40WSTB conducted noise measurement phase A with frequency jittering**

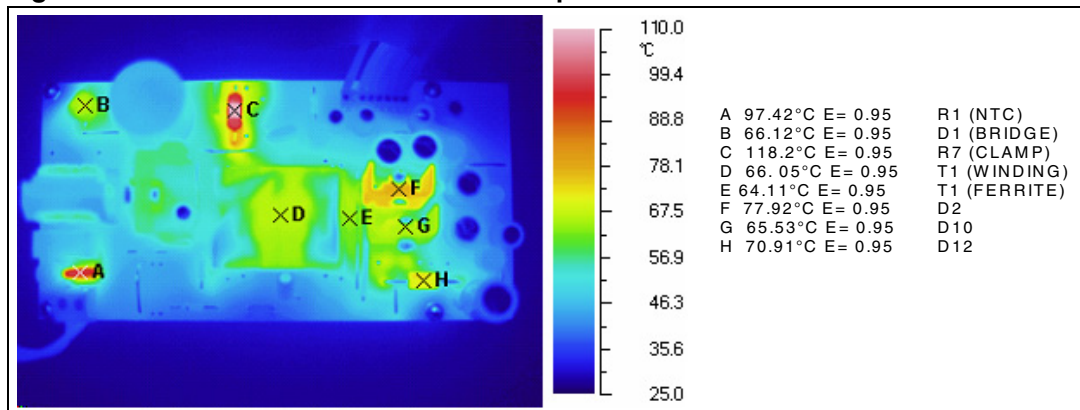


## 5 Thermal measures

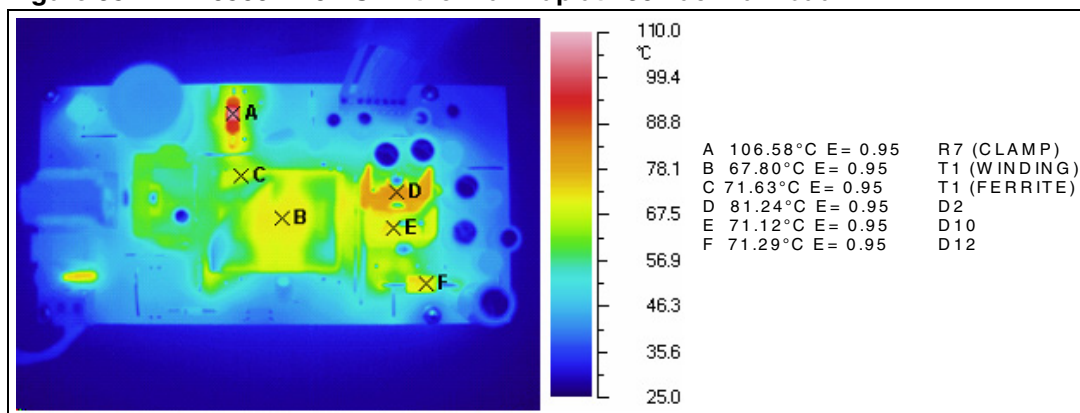
In order to check the design reliability, a thermal mapping by means of an IR camera was done. [Figure 34](#) and [35](#) show the thermal measures of the board, component side, at nominal input voltage. Some pointers visible on the pictures have been placed across key components or components showing high temperature. The correlation between measurement points and components is indicated on the right, on both diagrams.

Note:  $T_{AMB} = 25\text{ }^{\circ}\text{C}$  for all measures.

**Figure 34. EVL6566B-40WSTB thermal map at 115 Vac - full load**



**Figure 35. EVL6566B-40WSTB thermal map at 230 Vac - full load**



The temperature rise of the thermistor, bridge and output diodes is compatible with reliable operation of the components. Resistor R7 needs a bigger package to decrease its thermal resistance. All other components of the board are working within the temperature limits assuring a reliable long-term operation of the power supply.

## 6 Bill of material

**Table 8. Bill of material**

Ref. des.	Part type/part value	Description	Manufacturer	Case/style
C5	2N2-Y1	Y1 - SAFETY CAP. DE1E3KX222M	Murata	
C7	1N0	50 V CERCAP - General purpose	AVX	PTH
C9	470 $\mu$ F - 25 V	Aluminium ELCAP - YXF series	RUBYCON	
C10	470 $\mu$ F - 25 V	Aluminium ELCAP - YXF series	RUBYCON	
C11	100 $\mu$ F - 25 V	Aluminium ELCAP - YXF series	RUBYCON	
C12	100 N	50 V CERCAP - general purpose	AVX	1206
C14	100 N	50 V CERCAP - general purpose	AVX	0805
C15	100 N	50 V CERCAP - general purpose	AVX	0805
C16	100 N	50 V CERCAP - general purpose	AVX	1206
C17	100 N	50 V CERCAP - general purpose	AVX	0805
C18	220N-X2	X2 - FLM CAP - R46-I-3220-M1	Arcotronics	
C19	47 $\mu$ F - 50 V	Aluminium ELCAP - YXF series	Rubycon	
C20	82 $\mu$ - 400 V	Aluminium ELCAP - ECO S2GB820BA	Panasonic	
C21	10 N-400 V	Polyester CAP - MKT series	EPCOS	
C22	1000 $\mu$ F - 16 V	Aluminium ELCAP - YXF series	Rubycon	
C23	1000 $\mu$ F - 16 V	Aluminium ELCAP - YXF series	Rubycon	
C24	220 $\mu$ F - 16 V	Aluminium ELCAP - YXF series	Rubycon	
C25	220 pF	50 V CERCAP - general purpose	AVX	0805
C27	100 $\mu$ F - 25 V	Aluminium ELCAP - YXF series	Rubycon	
C28	100 $\mu$ F - 25 V	Aluminium ELCAP - YXF series	Rubycon	
C29	100 $\mu$ F - 25 V	Aluminium ELCAP - YXF series	Rubycon	
C30	2N2	50 V CERCAP - general purpose	AVX	1206
C31	47 N	50 V CERCAP - general purpose	AVX	1206
C32	100 N	50 V CERCAP - general purpose	AVX	0805
C33	10 N	50 V CERCAP - general purpose	AVX	1206
C34	220 p	50 V CERCAP - general purpose	AVX	0805
C35	2200 $\mu$ F - 16 V	Aluminium ELCAP - YXF series	Rubycon	
C36	100 N	50 V CERCAP - general purpose	AVX	1206
C37	3N3	50 V CERCAP - general purpose	AVX	0805
C38	100 N	50 V CERCAP - general purpose	AVX	0805
C39	100 N	50 V CERCAP - general purpose	AVX	0805

Table 8. Bill of material (continued)

Ref. des.	Part type/part value	Description	Manufacturer	Case/style
C41	1 $\mu$ - 50 V	Aluminium ELCAP - YXF series	Rubycon	
C100	100 N	50 V CERCAP - general purpose	AVX	1206
D1	2W06G	Single phase bridge rectifier	CHENYI ELECTR.	
D2	STPS8H100FP	Power Schottky rectifier	STMicroelectronics	TO-220FP
D5	STTH102A	Fast switching diode	STMicroelectronics	SMA
D7	STTH1L06U	HV ultrafast rectifier	STMicroelectronics	SMB
D9	STPS1L60A	Power Schottky rectifier	STMicroelectronics	SMA
D10	STPS10L60CFP	Power Schottky rectifier	STMicroelectronics	TO-220FP
D12	1N5821	Power Schottky rectifier	STMicroelectronics	DO-201
D13	LL4148	Fast switching diode	Vishay	MINIMELF
D16	LL4148	Fast switching diode	Vishay	MINIMELF
D17	TMMBAT43	Fast switching diode	STMicroelectronics	MINIMELF
F1	Fuse 2 A	Fuse T2A - time delay	Wichmann	
HS1	LS220	Q1 HEAT SINK	ABL aluminium COMP.	
HS2	507302	D2 HEAT SINK	AAVID thermalloy	
HS3	507302	D10 HEAT SINK	AAVID thermalloy	
J1	MKDS 1,5/ 2-5,08	Screw conn, PITCH 5 mm-2 W	Phoenix contact	
J2	MPT 0,5/ 8-2,54	Screw conn, PITCH 2.5 mm-8 W	Phoenix contact	
L1	HF2430-203Y1R0	Input EMI filter	TDK	
L2	2.7 $\mu$ H	Radial inductor - ELC08D2R7E	Panasonic	
L3	2.7 $\mu$ H	Radial inductor - ELC08D2R7E	Panasonic	
L4	22 $\mu$ H	Radial inductor - RCH654	Sumida	
L5	2.7 $\mu$ H	Radial inductor - ELC08D2R7E	Panasonic	
Q1	STP4NK60ZFP	N-channel power MOSFET	STMicroelectronics	TO-220FP
Q2	BC847B	NPN small signal BJT	Zetex	SOT-23
Q3	BC847B	NPN small signal BJT	Zetex	SOT-23
Q4	BC857B	PNP small signal BJT	Zetex	SOT-23
Q5	BC857B	PNP small signal BJT	Zetex	SOT-23
R1	NTC 10R-S236	NTC resistor P/N B57236S0100M000	EPCOS	
R2	3R9	SFR25 AXIAL stand. film RES - 0.4 W	Vishay	PTH
R4	4K7	SFR25 AXIAL stand. film RES - 0.4 W	Vishay	PTH
R5	3M3	SMD standard film RES - 1/4 W - 1%	Vishay	1206
R6	2M7	SMD standard film RES - 1/4 W - 1%	Vishay	1206

Table 8. Bill of material (continued)

Ref. des.	Part type/part value	Description	Manufacturer	Case/style
R7	33 k $\Omega$ -2 W	SFR25 axial stand. film RES - 0.4 W	Vishay	PTH
R10	10 k $\Omega$	SMD standard film RES - 1/8 W - 1%	Vishay	0805
R12	56 k $\Omega$	SMD standard film RES - 1/4 W - 1%	Vishay	1206
R13	15K	SMD standard film RES - 1/4 W - 1%	Vishay	1206
R14	4K3	SMD standard film RES - 1/4 W - 5%	Vishay	1206
R15	33K0	SMD standard film RES - 1/4 W - 1%	Vishay	1206
R16	1K0	SFR25 axial stand. film RES - 0.4 W	Vishay	PTH
R17	82 $\Omega$	SMD standard film RES - 1/4 W - 5%	Vishay	1206
R18	1R0	SFR25 axial stand. film res - 0.4 W	Vishay	PTH
R19	1R0	SFR25 axial stand. film res - 0.4 W	Vishay	PTH
R20	3K9	SMD standard film RES - 1/4 W - 5%	Vishay	1206
R21	15 k $\Omega$	SMD standard film RES - 1/4 W - 1%	Vishay	1206
R22	33 k $\Omega$	SFR25 axial stand. film RES - 0.4 W	Vishay	PTH
R23	1K0	SMD standard film RES - 1/8 W - 1%	Vishay	0805
R24	1K0	SMD standard film RES - 1/4 W - 1%	Vishay	1206
R25	3K3	SMD standard film RES - 1/8 W - 1%	Vishay	0805
R26	1K0	SMD standard film RES - 1/8 W - 1%	Vishay	0805
R27	6K8	SFR25 AXIAL stand. film res - 0.4 W	Vishay	PTH
R28	1K0	SMD standard film RES - 1/8 W - 1%	Vishay	0805
R29	10 k $\Omega$	SMD standard film RES - 1/8 W - 1%	Vishay	0805
R30	270 $\Omega$	SMD standard film RES - 1/8 W - 1%	Vishay	0805
R31	200 k $\Omega$	SFR25 AXIAL stand. film res - 0.4 W	Vishay	PTH
R33	1K0	SMD standard film RES - 1/4 W - 5%	Vishay	1206
R34	270 $\Omega$	SMD standard film RES - 1/4 W - 5%	Vishay	1206
R35	2K2	SMD standard film RES - 1/8 W - 5%	Vishay	0805
R36	47 k $\Omega$	SMD standard film RES - 1/8 W - 1%	Vishay	0805
R37	22 k $\Omega$	SMD standard film RES - 1/4 W - 5%	Vishay	1206
R39	0R0	SMD standard film RES - 1/4 W - 5%	Vishay	1206
R40	390 k $\Omega$	SMD standard film RES - 1/4 W - 1%	Vishay	1206
R42	100 $\Omega$	SMD standard film RES - 1/4 W - 5%	Vishay	1206
R43	1K8	SMD standard film RES - 1/8 W - 1%	Vishay	0805
R44	1K0	SMD standard film RES - 1/8 W - 5%	Vishay	0805
R45	1K8	SMD standard film RES - 1/8 W - 1%	Vishay	0805
R46	0R0	SMD standard film RES - 1/4 W - 5%	Vishay	1206

Table 8. Bill of material (continued)

Ref. des.	Part type/part value	Description	Manufacturer	Case/style
R101	0R0	SMD standard film RES	Vishay	1206
T1	SRW28LEC-E01	Power transformer	TDK	
U2	L6566B	Multi-mode PWM controller	STMicroelectronics	SO-16
U3	SFH617A-4	Optocoupler	Infineon	DIP4
U4	TS2431ILT	Voltage reference	STMicroelectronics	SOT-23

# 7 PCB layout

Figure 36. Silk screen - top side

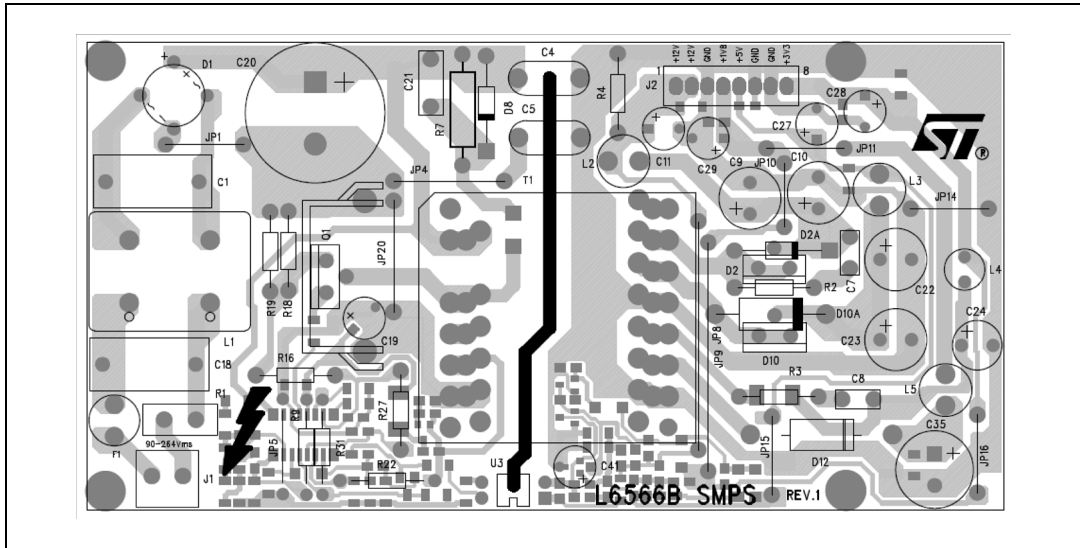
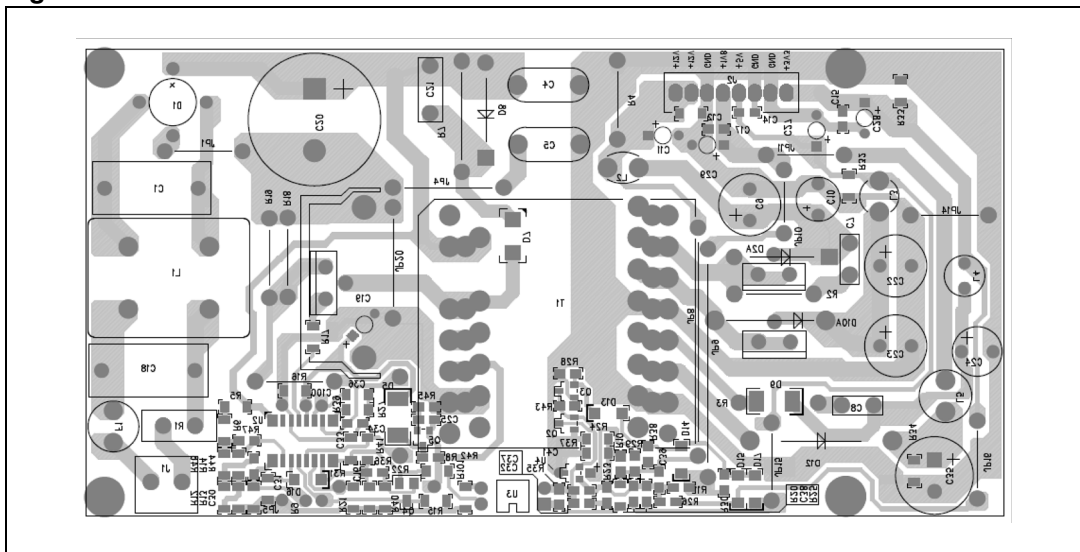


Figure 37. Silk screen - bottom side





## 8 Transformer specifications

- Application type: consumer, home appliance
- Transformer type: open
- Winding type: layer
- COIL former: horizontal type, 6+6 pins
- Max. temp. rise: 45 °C
- Max. operating ambient temp.: 60 °C
- Mains insulation: accordance with EN60065.

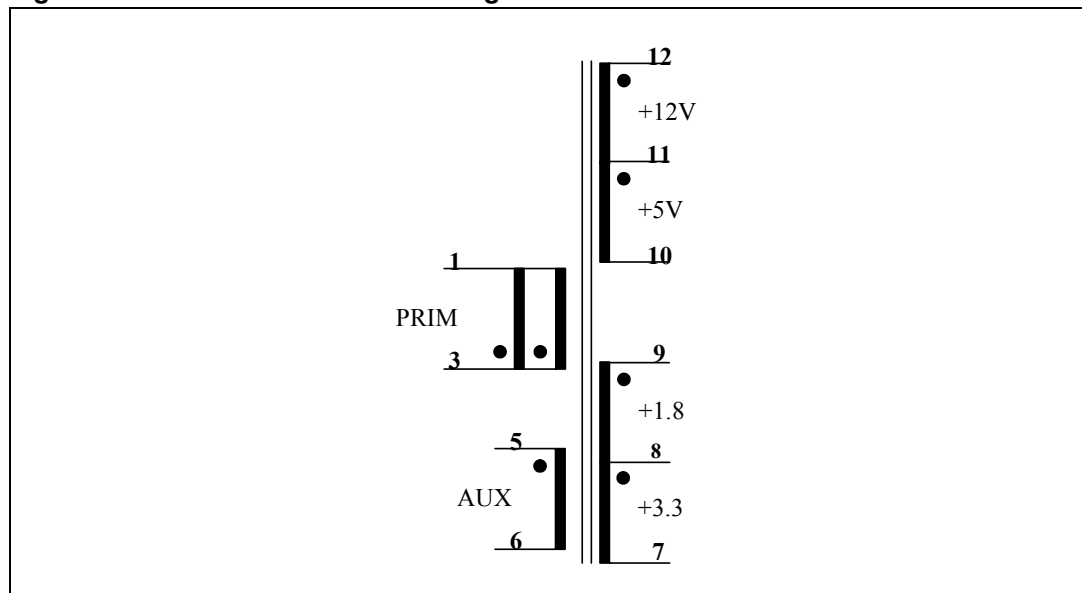
### Electrical characteristics

- Converter topology: flyback, CCM/DCM mode
- Core type: EER28L - PC40 or equivalent
- Typical operating freq.: 65 kHz
- Primary inductance: 910  $\mu$ H 10% at 1 kHz - 0.25 V (see [Note 1](#))
- Leakage inductance: 15  $\mu$ H max at 100 kHz - 0.25 V (see [Note 1, 2](#))
- Max. peak primary current: 1.65 Apk
- RMS primary current: 0.65 ARMS.

- Note:*
- 1 Measured between pins 1-3
  - 2 Measured between pins 1-3 with all secondary windings shorted.

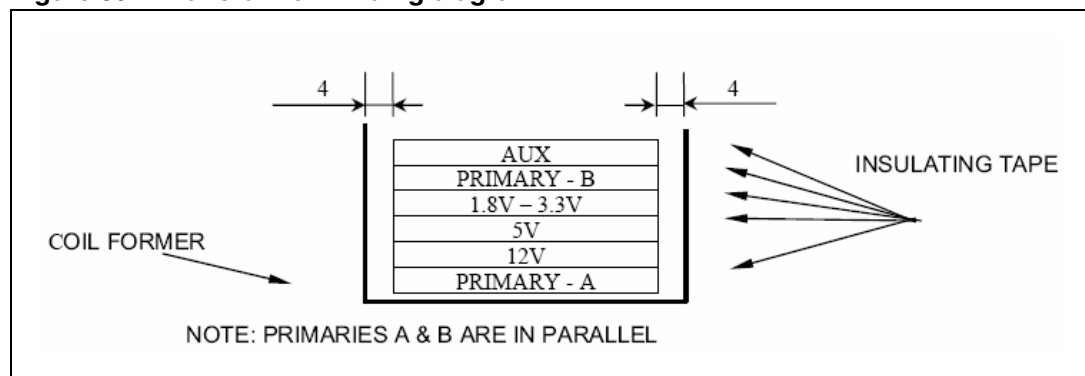
### Electrical diagram

**Figure 38. Transformer electrical diagram**



**Table 9. Transformer winding characteristics**

Pins	Winding	O/P RMS current	Number of turns	Wire type
3-1	PRIMARY - A	0.32 A <sub>RMS</sub>	95	G2 – 2 x $\phi$ 0.23 mm
12-11	12 V	2.3 A <sub>RMS</sub>	9	G2 – 3 x $\phi$ 0.45 mm
11-10	5 V	3 A <sub>RMS</sub>	7 spaced	G2 – 3 x $\phi$ 0.45 mm
9-8	3.3 V	0.6 A <sub>RMS</sub>	2	G2 – 3 x $\phi$ 0.45 mm
8-7	1.8 V	2.1 A <sub>RMS</sub>	3	G2 – 3 x $\phi$ 0.45 mm
3-1	PRIMARY - B	0.32 A <sub>RMS</sub>	95	G2 – 2 x $\phi$ 0.23 mm
5-6	AUX	0.05 A <sub>RMS</sub>	17 spaced	G2 – $\phi$ 0.23 mm

**Figure 39. Transformer winding diagram****Mechanical aspect**

- Maximum height from PCB: 30 mm
- Coil former type: horizontal, 6+6 pins (pins 2, 4 are removed)
- Pin distance: 5 mm
- Row distance: 30 mm
- Pins #3 and 4 removed
- External copper shield: 12 mm width

**Manufacturer**

- TDK Electronics Europe - Germany
- Transformer P/N: SRW28LEC-E01H117

## 9 Conclusion

An SMPS for set-top box has been completely designed and tested, with positive results from all aspects (functionality, protections, EMI and component thermal stress). Thanks to the L6566B, the design offers high performance at low cost which is a key driver in the consumer electronics market.

### 9.1 References

1. "L6566B datasheet".

## 10 Revision history

Table 10. Document revision history

Date	Revision	Changes
23-Jul-2008	1	Initial release
08-Jun-2010	2	Modified: <i>Figure 11</i> , <i>34</i> and <i>35</i>

**Please Read Carefully:**

Information in this document is provided solely in connection with ST products. STMicroelectronics NV and its subsidiaries ("ST") reserve the right to make changes, corrections, modifications or improvements, to this document, and the products and services described herein at any time, without notice.

All ST products are sold pursuant to ST's terms and conditions of sale.

Purchasers are solely responsible for the choice, selection and use of the ST products and services described herein, and ST assumes no liability whatsoever relating to the choice, selection or use of the ST products and services described herein.

No license, express or implied, by estoppel or otherwise, to any intellectual property rights is granted under this document. If any part of this document refers to any third party products or services it shall not be deemed a license grant by ST for the use of such third party products or services, or any intellectual property contained therein or considered as a warranty covering the use in any manner whatsoever of such third party products or services or any intellectual property contained therein.

**UNLESS OTHERWISE SET FORTH IN ST'S TERMS AND CONDITIONS OF SALE ST DISCLAIMS ANY EXPRESS OR IMPLIED WARRANTY WITH RESPECT TO THE USE AND/OR SALE OF ST PRODUCTS INCLUDING WITHOUT LIMITATION IMPLIED WARRANTIES OF MERCHANTABILITY, FITNESS FOR A PARTICULAR PURPOSE (AND THEIR EQUIVALENTS UNDER THE LAWS OF ANY JURISDICTION), OR INFRINGEMENT OF ANY PATENT, COPYRIGHT OR OTHER INTELLECTUAL PROPERTY RIGHT.**

**UNLESS EXPRESSLY APPROVED IN WRITING BY AN AUTHORIZED ST REPRESENTATIVE, ST PRODUCTS ARE NOT RECOMMENDED, AUTHORIZED OR WARRANTED FOR USE IN MILITARY, AIR CRAFT, SPACE, LIFE SAVING, OR LIFE SUSTAINING APPLICATIONS, NOR IN PRODUCTS OR SYSTEMS WHERE FAILURE OR MALFUNCTION MAY RESULT IN PERSONAL INJURY, DEATH, OR SEVERE PROPERTY OR ENVIRONMENTAL DAMAGE. ST PRODUCTS WHICH ARE NOT SPECIFIED AS "AUTOMOTIVE GRADE" MAY ONLY BE USED IN AUTOMOTIVE APPLICATIONS AT USER'S OWN RISK.**

Resale of ST products with provisions different from the statements and/or technical features set forth in this document shall immediately void any warranty granted by ST for the ST product or service described herein and shall not create or extend in any manner whatsoever, any liability of ST.

ST and the ST logo are trademarks or registered trademarks of ST in various countries.

Information in this document supersedes and replaces all information previously supplied.

The ST logo is a registered trademark of STMicroelectronics. All other names are the property of their respective owners.

© 2010 STMicroelectronics - All rights reserved

STMicroelectronics group of companies

Australia - Belgium - Brazil - Canada - China - Czech Republic - Finland - France - Germany - Hong Kong - India - Israel - Italy - Japan - Malaysia - Malta - Morocco - Philippines - Singapore - Spain - Sweden - Switzerland - United Kingdom - United States of America

[www.st.com](http://www.st.com)