

TABLE 1			
ITEM	COMPONENT	HH	GF
1	SUB ASSEMBLY	SUB-CJT-T-P-HH-RA-BH1	SUB-CJT-T-P-GF-RA-BH1
2	NUT	SMA-NUT-001-F	
3	WASHER	SMA-LWAS-001-F	
4	GASKET	CJT-GKT-001	

DESIGNED & DIMENSIONED IN MILLIMETERS [INCHES]

CJT-T-P-XX-RA-BH1

GENDER
-J: JACK

TYPE
-T: TERMINAL

TYPE
-P: PCB

TERMINATION
-BHT: BULKHEAD THROUGH HOLE

ORIENTATION
-RA: RIGHT ANGLE

PLATING SPECIFICATION
-HH: HEAVY GOLD / HEAVY GOLD
30µ" Au / 50µ" Ni MIN ON PIN
30µ" Au / 50µ" Ni MIN ON OUTER CONTACT
-GF: GOLD / FLASH GOLD
10µ" Au / 50µ" Ni MIN ON PIN
3µ" Au / 50µ" Ni MIN ON OUTER CONTACT
(SEE TABLE 1)

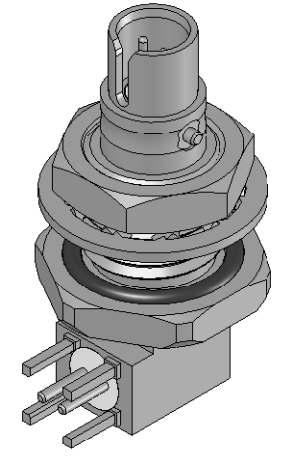
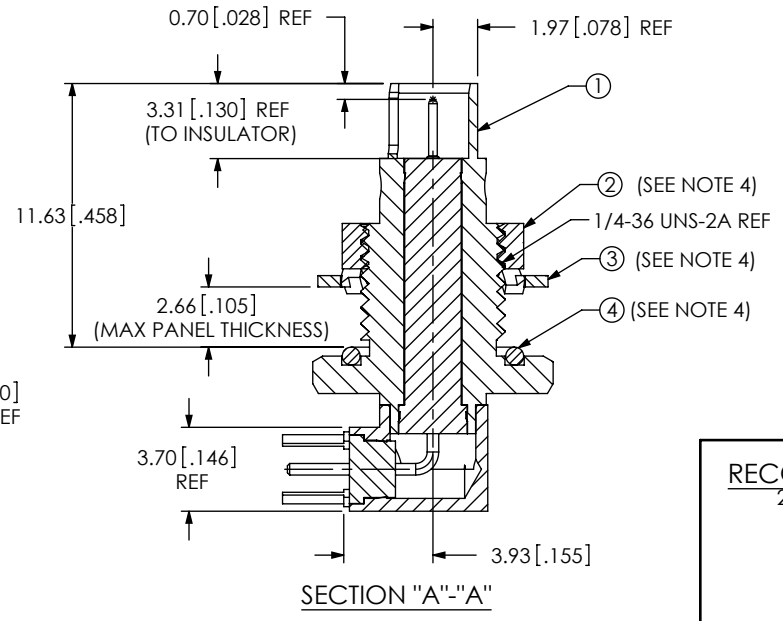
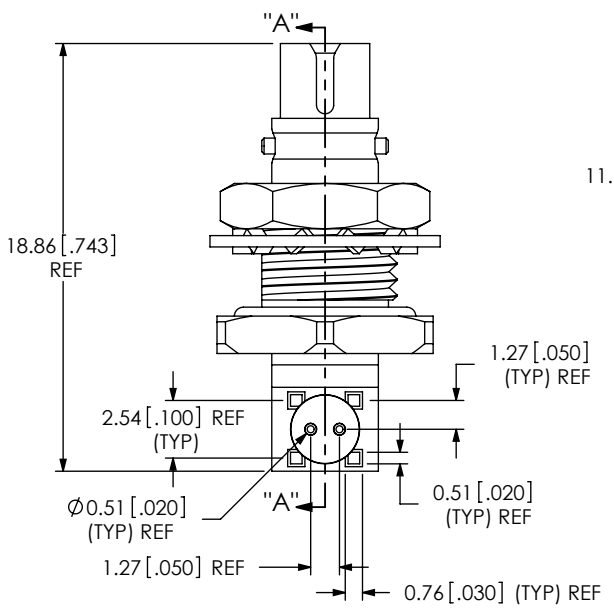
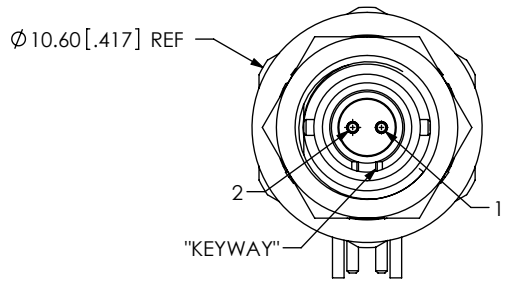

RECOMMENDED MOUNTING HOLE
2.66 [.105] MAX PANEL THICKNESS

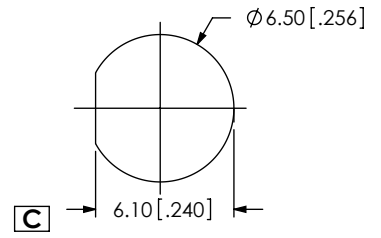

- NOTES:
- ⊙ REPRESENTS A CRITICAL DIMENSION.
 - MINIMUM PUSHOUT FORCE FOR CENTER CONTACT: 10 N [2.25 LB].
INSULATOR: 20 N [4.5 LB].
 - PRODUCT TO BE PACKAGED PER PACKAGING STANDARD CO-HD-WI-3040-M.
TRAY: TY-SMA001-1,
COVER: TY-SMA001-2.
 - NUT, WASHER, AND GASKET ARE PACKAGED SEPARATELY.

UNLESS OTHERWISE SPECIFIED, DIMENSIONS ARE IN MILLIMETERS.

TOLERANCES ARE:

DECIMALS	ANGLES
X.X: ±0.3 [01]	5°
X.XX: ±0.13 [005]	
X.XXX: ±0.051 [0020]	

PROPRIETARY NOTE
THIS DOCUMENT CONTAINS INFORMATION CONFIDENTIAL AND PROPRIETARY TO SAMTEC, INC. AND SHALL NOT BE REPRODUCED OR TRANSFERRED TO OTHER DOCUMENTS OR DISCLOSED TO OTHERS OR USED FOR ANY PURPOSE OTHER THAN THAT WHICH IT WAS OBTAINED WITHOUT THE EXPRESSED WRITTEN CONSENT OF SAMTEC, INC.



520 PARK EAST BLVD. NEW ALBANY, IN 47150
PHONE: 812-944-6733 FAX: 812-948-5047
e-Mail: info@SAMTEC.com code 55322

MATERIAL: DO NOT SCALE DRAWING SHEET SCALE: 3:1

CONTACT: PHOS BRONZE
OTHER METAL: BRASS
DIELECTRIC: PTFE
GASKET: SILICONE

DESCRIPTION:
CIRCULAR TWIN-AX JACK RIGHT ANGLE BULKHEAD

DWG. NO.
CJT-T-P-XX-RA-BH1

BY: ALVIN W 12/01/2010 SHEET 1 OF 2

RECOMMENDED PCB LAYOUT

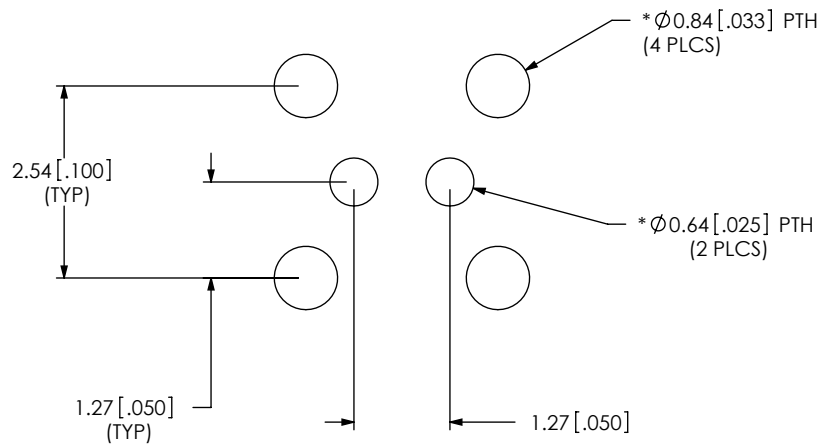

* TO BE SOLDERED USING PASTE-IN-HOLE TECHNOLOGY.

RECOMMENDED STENCIL LAYOUT

NOTE:
STENCIL TO BE .152[.0060] THICK

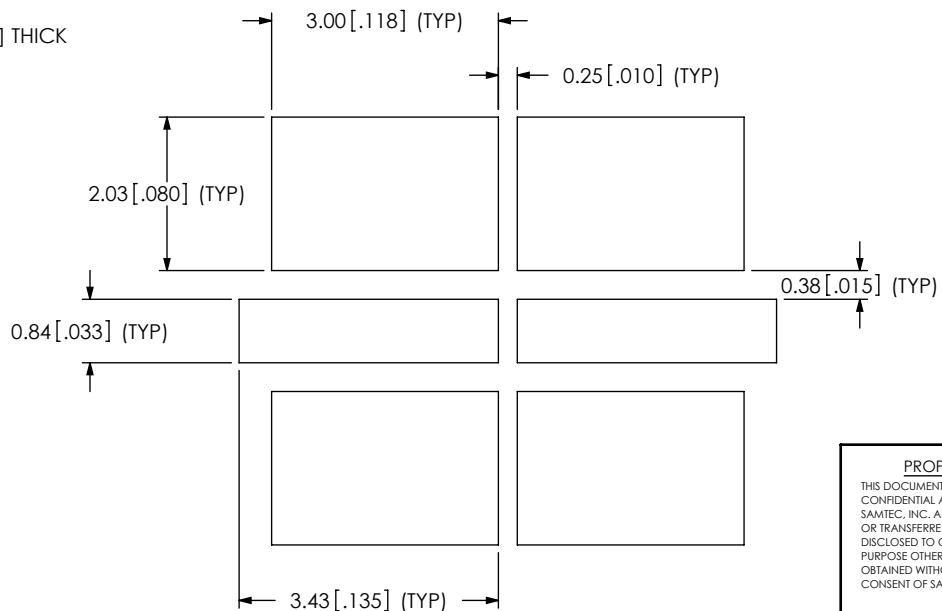

PROPRIETARY NOTE

THIS DOCUMENT CONTAINS INFORMATION CONFIDENTIAL AND PROPRIETARY TO SAMTEC, INC. AND SHALL NOT BE REPRODUCED OR TRANSFERRED TO OTHER DOCUMENTS OR DISCLOSED TO OTHERS OR USED FOR ANY PURPOSE OTHER THAN THAT WHICH IT WAS OBTAINED WITHOUT THE EXPRESSED WRITTEN CONSENT OF SAMTEC, INC.

DO NOT SCALE DRAWING

SHEET SCALE: 10:1



520 PARK EAST BLVD, NEW ALBANY, IN 47150
PHONE: 812-944-6733 FAX: 812-948-5047
e-Mail info@SAMTEC.com code 55322

DESCRIPTION:
CIRCULAR TWIN-AX JACK RIGHT ANGLE BULKHEAD

DWG. NO. CJT-T-P-XX-RA-BH1

BY: ALVIN W 12/01/2010 SHEET 2 OF 2