

# SURFACE MOUNT LED RED/GREEN, 1210 PACKAGE

# BIVAR



## SM1210BC-UR/UG

- ◆ Industry Standard Package
- ◆ RoHS Compliant
- ◆ Two Chips in One Package
- ◆ Water Clear Lens
- ◆ Wide Viewing Angle
- ◆ Ideal for Status Indication and Lighting

Bivar Surface Mount 1210 package Bi-Color LED combines two chips in a single package. They are ideal for small scale applications where multiple signals need to be displayed. When needed, the third color can be created by powering up both chips together. Bivar offers water clear LED lens for high luminous intensity and wide viewing angles. Wide variety of color and intensity combinations are available to meet any illumination need. The SM1210 LED is packaged in standard tape and reels for pick and place assemblies.

Part Number	Material	Emitted Color	Peak Wavelength $\lambda_p$ (nm) TYP.	Lens Appearance	Luminous Intensity (mcd) TYP.	Viewing Angle
SM1210BC-UR/UG	AlGaInP	RED	645	Water Clear	108	130°
	AlGaInP	GREEN	575		68	

## Outline Dimensions

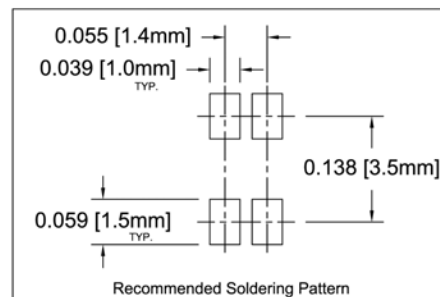
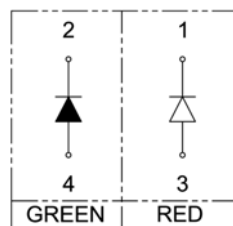
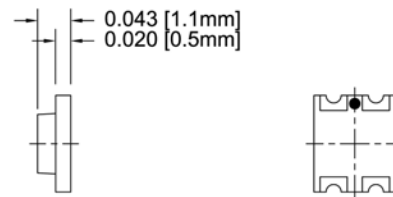
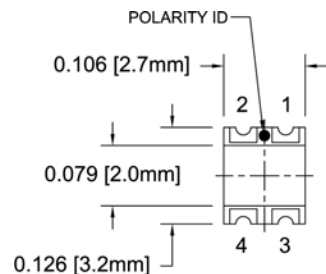

### Outline Drawings Notes:

1. All dimensions are in inches [millimeters].
2. Standard tolerance:  $\pm 0.010''$  unless otherwise noted.



Bivar reserves the right to make changes at any time without notice.

# SURFACE MOUNT LED RED/GREEN, 1210 PACKAGE



## Absolute Maximum Ratings

$T_A = 25^\circ\text{C}$  unless otherwise noted

Power Dissipation	78 mW
Forward Current ( DC )	30 mA
Peak Forward Current <sup>1</sup>	100 mA
Reverse Voltage	5 V
Operating Temperature Range	-30 ~ +80°C
Storage Temperature Range	-40 ~ +85°C
Lead Soldering Temperature ( 3 mm from the base of the epoxy bulb ) <sup>2</sup>	260°C

Notes: 1. 10% Duty Cycle, Pulse Width  $\leq$  0.1 msec. 2. Solder time less than 5 seconds at temperature extreme.

## Electrical / Optical Characteristics

$T_A = 25^\circ\text{C}$  &  $I_F = 20$  mA unless otherwise noted

Part Number	Emitted color	Forward Voltage (V) <sup>1</sup>			Recommend Forward Current (mA)			Reverse Current ( $\mu$ A)	Dominant Wavelength (nm) <sup>2</sup>			Luminous Intensity $I_v$ (mcd)			Viewing Angle $2\theta_{1/2}$ (deg)
		MIN	TYP	MAX	MIN	TYP	MAX	MAX	MIN	TYP	MAX	MIN	TYP	MAX	TYP
SM1210BC-UR/UG	RED	/	2.1	2.6	/	20	/	10	/	631	/	90	108	/	130
	GREEN	/	2.1	2.6	/	20	/	10	/	574	/	40	68	/	130

Notes: 1. Tolerance of forward voltage :  $\pm 0.05\text{V}$ . 2. Tolerance of dominant wavelength :  $\pm 1.0\text{nm}$ .

Bivar reserves the right to make changes at any time without notice.

# SURFACE MOUNT LED RED/GREEN, 1210 PACKAGE



## Typical Electrical / Optical Characteristics

$T_A = 25^\circ\text{C}$  unless otherwise noted

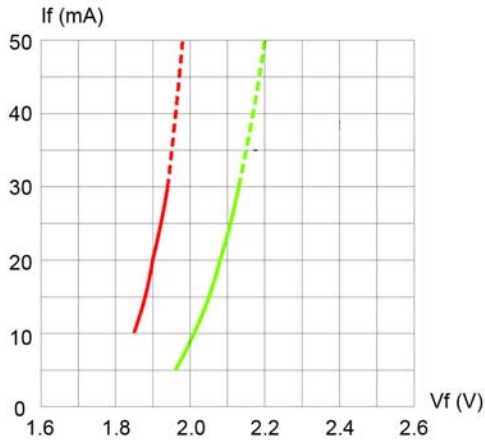

Fig. 1 Forward Current vs. Forward Voltage

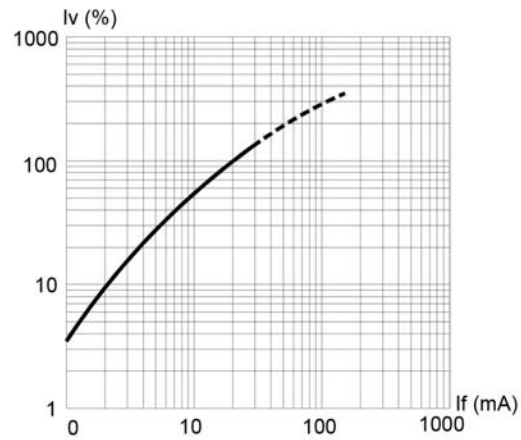

Fig. 2 Relative Luminous Intensity vs. Forward Current

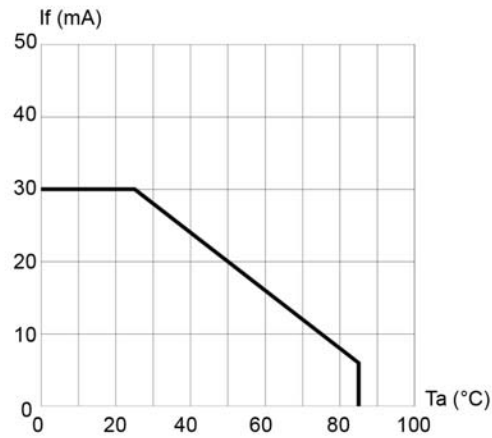

Fig. 3 Forward Current vs. Temperature

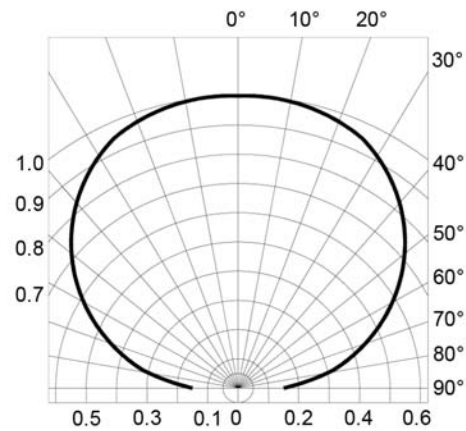

Fig. 4 Directivity Radiation Diagram

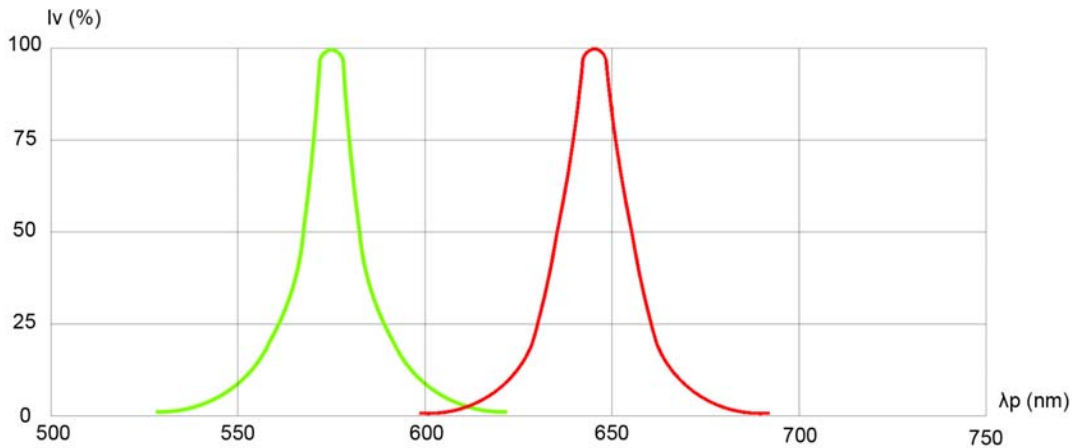

Fig. 5 Relative Luminous Intensity vs. Peak Wavelength

Bivar reserves the right to make changes at any time without notice.

# SURFACE MOUNT LED RED/GREEN, 1210 PACKAGE



## Recommended Soldering Conditions

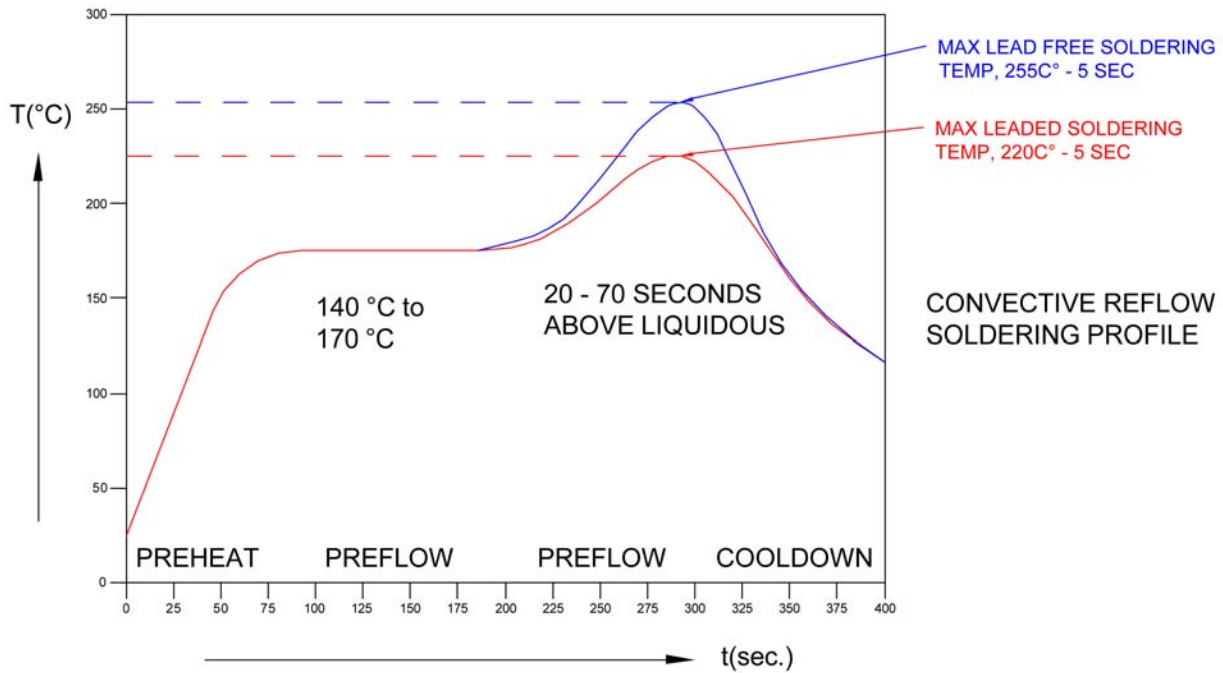

## Tape and Reel Dimensions

**Note: 3000 pcs/Reel**

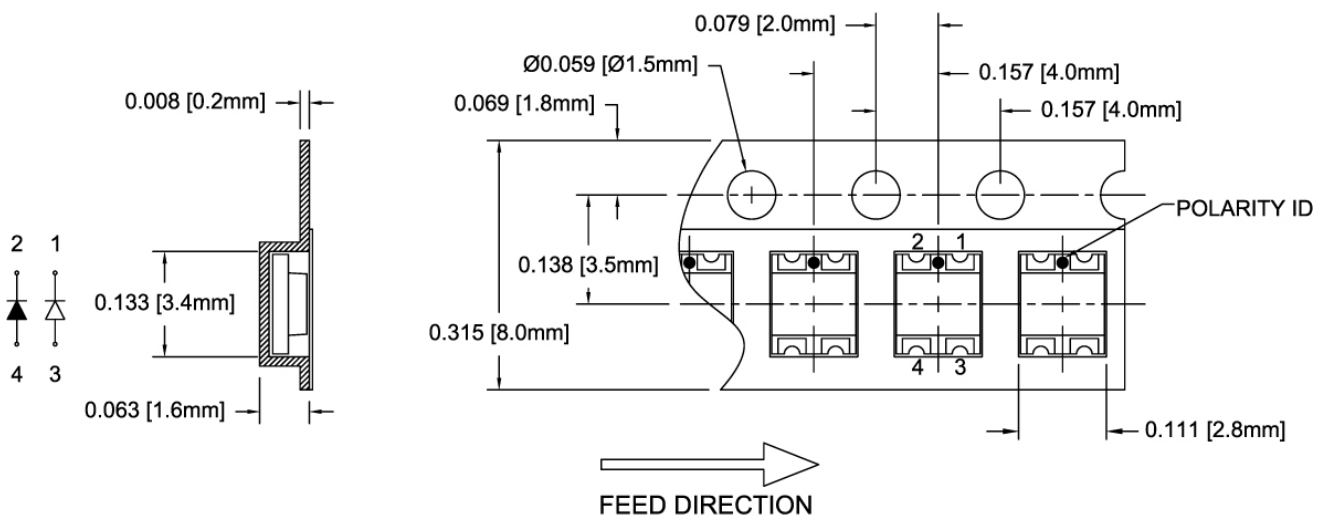

### Outline Drawings Notes:

1. All dimensions are in inches [millimeters].
2. Standard tolerance:  $\pm 0.010''$  unless otherwise noted.

Bivar reserves the right to make changes at any time without notice.

# SURFACE MOUNT LED RED/GREEN, 1210 PACKAGE



### Outline Drawings Notes:

1. All dimensions are in inches [millimeters].
2. Standard tolerance unless otherwise noted: X.XXX ± 0.010"  
X.X ± 0.1"

## Packaging and Labeling Plan

Note: 1 Reel / Bag

Sealed ESD and Moisture Barrier Bag

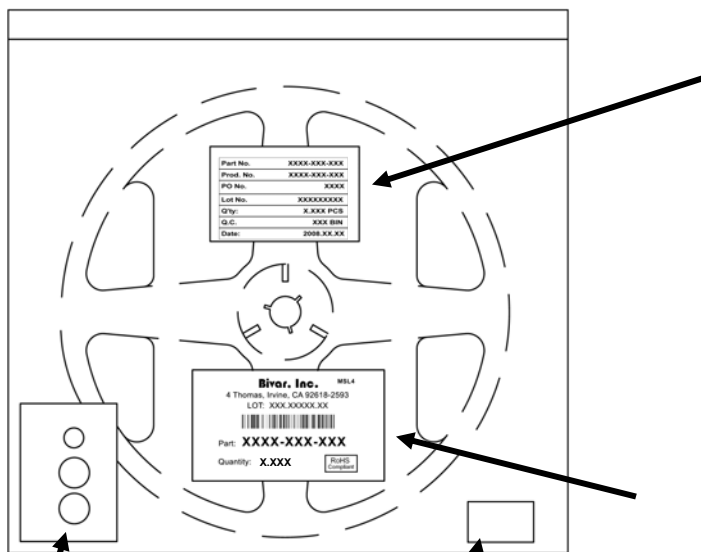

Humidity Indicator Card

Desiccant Card

Part No.	XXXX-XXX-XXX
Prod. No.	XXXX-XXX-XXX
PO No.	XXXX
Lot No.	XXXXXXXXXX
Q'ty:	X.XXX PCS
Q.C.	XXX BIN
Date:	2008.XX.XX

Internal Quality Control Label

**Bivar, Inc.** MSL4

4 Thomas, Irvine, CA 92618-2593  
LOT: XXX.XXXXX.XX



Part: **XXXX-XXX-XXX**

Quantity: **X.XXX**

RoHS Compliant

Bivar Standard Packaging Label

Bivar reserves the right to make changes at any time without notice.