

# 7.0V~28V Input, 3A Integrated MOSFET Single Synchronous Buck DC/DC Converter

## BD9E302EFJ

### ● General Description

BD9E302EFJ is a synchronous buck switching regulator with built-in power MOSFETs. High efficiency at light load with a SLLM™ (Simple Light Load Mode). It is most suitable for use in the equipment to reduce the standby power is required. It is a current mode control DC/DC converter and features high-speed transient response. Phase compensation can also be set easily.

### ● Key Specifications

■ Input voltage range:	7.0V to 28V
■ Output voltage range:	1.0V to $V_{IN} \times 0.7V$
■ Output current:	3.0 A (Max)
■ Switching frequency:	550 kHz (Typ)
■ High-Side MOSFET on-resistance:	90 mΩ (Typ)
■ Low-Side MOSFET on-resistance:	70 mΩ (Typ)
■ Shutdown current:	0 μA (Typ)

### ● Features

- Synchronous single DC/DC converter
- SLLM™ control (Simple Light Load Mode)
- Over current protection
- Short circuit protection
- Thermal shutdown protection
- Under voltage lockout protection
- Soft start
- Reduce external diode
- HTSOP-J8 package

### ● Applications

- Consumer applications such as home appliance
- Secondary power supply and Adapter equipment
- Telecommunication devices

### ● Package

HTSOP-J8	W (Typ) x D (Typ) x H (Max) 4.90 mm x 6.00 mm x 1.00 mm
----------	--

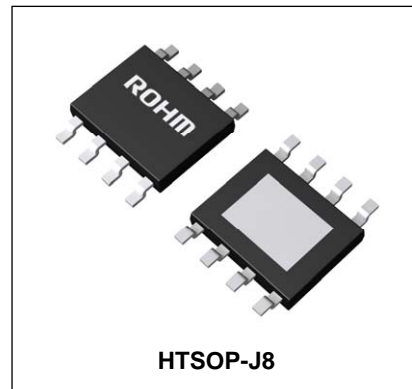

### ● Typical Application Circuit

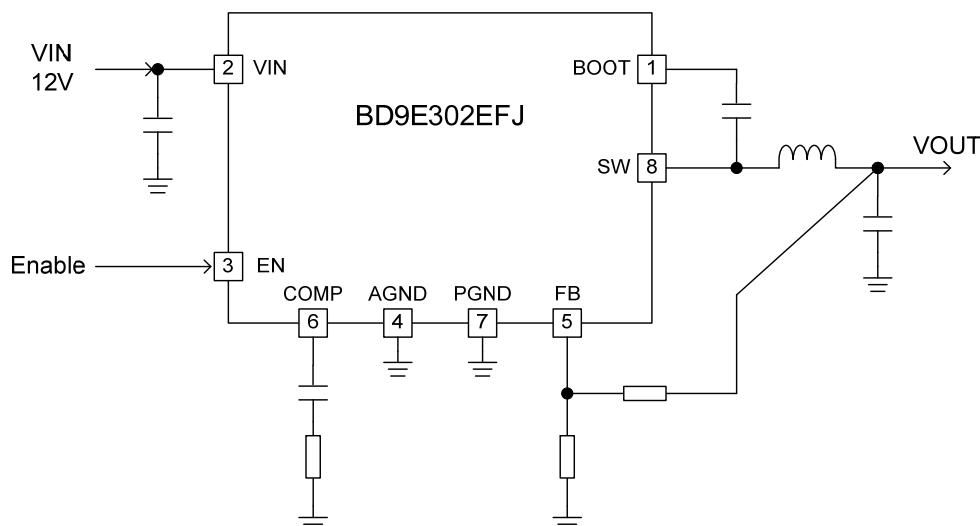

Figure 1. Application circuit

## ● Pin Configuration

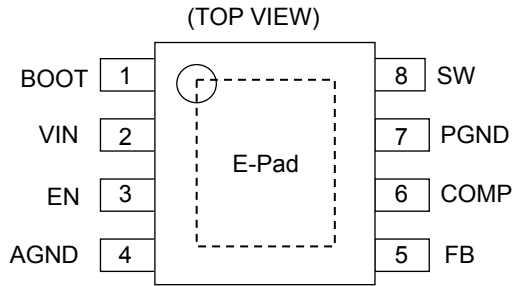

Figure 2. Pin assignment

## ● Pin Descriptions

Pin No.	Pin Name	Description
1	BOOT	Connect a bootstrap capacitor of 0.1 $\mu\text{F}$ between this terminal and SW terminal. The voltage of this capacitor is the gate drive voltage of the high-side MOSFET.
2	VIN	Power supply terminal for the switching regulator and control circuit. Connecting 10 $\mu\text{F}$ +0.1 $\mu\text{F}$ ceramic capacitor is recommended.
3	EN	Turning this terminal signal low-level (0.8 V or lower) forces the device to enter the shutdown mode. Turning this terminal signal high-level (2.5 V or higher) enables the device. This terminal must be terminated.
4	AGND	Ground terminal for the control circuit.
5	FB	Inverting input node for the gm error amplifier. See page 30 for how to calculate the resistance of the output voltage setting.
6	COMP	Input terminal for the gm error amplifier output and the output switch current comparator. Connect a frequency phase compensation component to this terminal. See page 33 for how to calculate the resistance and capacitance for phase compensation.
7	PGND	Ground terminal for the output stage of the switching regulator.
8	SW	Switch node. This terminal is connected to the source of the high-side MOSFET and drain of the low-side MOSFET. Connect a bootstrap capacitor of 0.1 $\mu\text{F}$ between these terminals and BOOT terminals. In addition, connect an inductor considering the direct current superimposition characteristic.
-	E-Pad	Exposed pad. Connecting this to the internal PCB ground plane using multiple vias provides excellent heat dissipation characteristics.

● Block Diagram

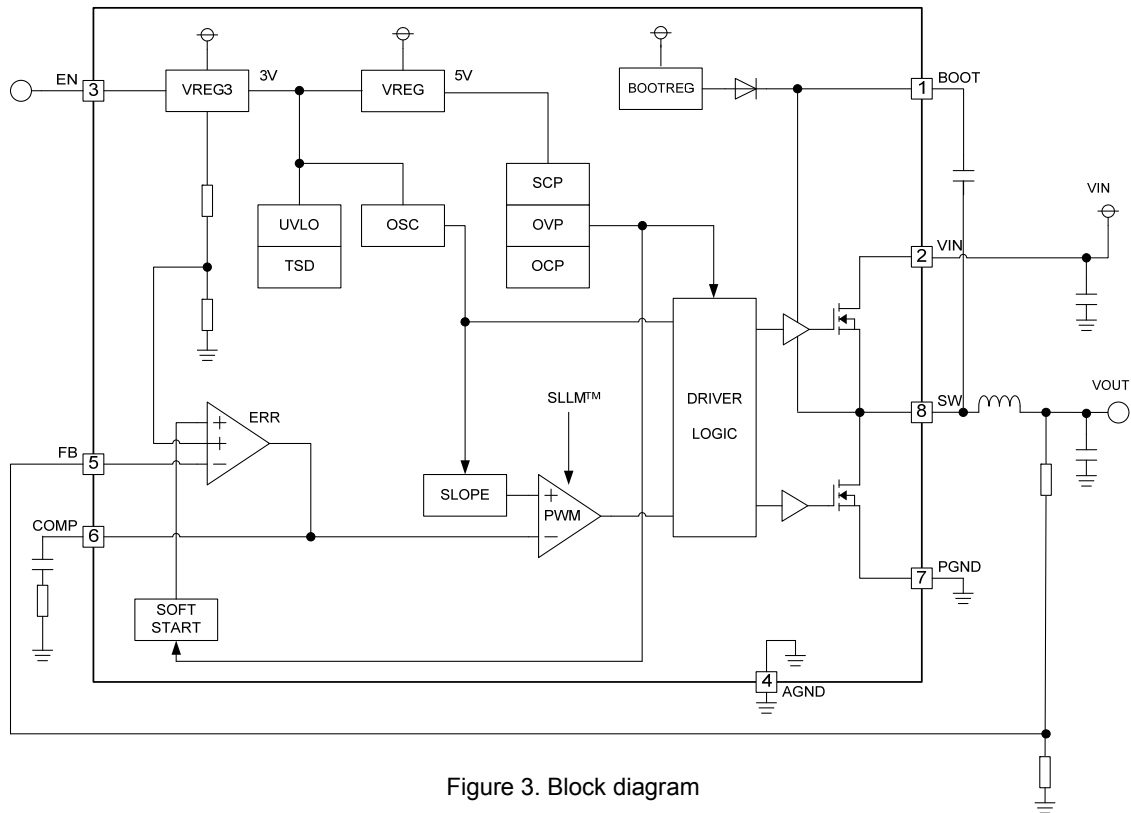

Figure 3. Block diagram

**● Description of Blocks**

- VREG3  
Block creating internal reference voltage 3V (Typ).
- VREG  
Block creating internal reference voltage 5V (Typ).
- BOOTREG  
Block creating gate drive voltage.
- TSD  
This is thermal shutdown block. Usually IC operating in the allowable power dissipation, but when the IC power dissipation more than rating value,  $T_j$  will increase, when the chip temperature exceeds 175°C (Typ), The thermal shutdown circuit is intended for shutting down internal power devices. Then the  $T_j$  will decreased and IC restart. It is not meant to protect or guarantee the soundness of the application. Do not use the function of this circuit for application protection design.
- UVLO  
This is under voltage lockout block. Avoid the IC miss operation at low  $V_{IN}$  or  $V_{IN}$  start up, IC shuts down when  $V_{IN}$  under 6.4V (Typ). When UVLO release, the IC restart, Still the threshold voltage has hysteresis of 200mV (Typ).
- ERR  
The ERR block is an error amplifier and its inputs are the reference voltage 0.8 V (Typ) and the "FB" pin voltage. (Refer to recommended examples on page 33). The output "COMP" pin controls the switching duty, the output voltage is set by "FB" pin with external resistors. Moreover, the external resistor and capacitor are required to COMP pin as phase compensation circuit.
- OSC  
Block generating oscillation frequency.
- SLOPE  
Creates delta wave from clock, generated by OSC, and sends voltage composed by current sense signal of high side MOSFET and delta wave to PWM comparator.
- PWM  
Settles switching duty by comparing output COMP terminal voltage of error amplifier and signal of SLOPE part.
- DRIVER LOGIC  
This is DC/DC driver block. Input signal from PWM and drives MOSFET.
- SOFT START  
By controlling current output voltage starts calmly preventing over shoot of output voltage and inrush current.
- OCP  
Current flowing in high side MOSFET is controlled one circle each of switching frequency when over current occurs.
- SCP  
The short circuit protection block compares the FB terminal voltage with the internal standard voltage VREF. When the FB terminal voltage has fallen below 0.56 V (Typ) and remained there for 0.9 msec (Typ), SCP stops the operation for 14.4 msec (Typ) and subsequently initiates a restart.
- OVP  
Over voltage protection function (OVP) compares FB terminal voltage with the internal standard voltage VREF. When the FB terminal voltage exceeds 1.04V (Typ) it turns MOSFET of output part MOSFET OFF. After output voltage drop it returns with hysteresis.

● Absolute Maximum Ratings (Ta = 25°C)

Parameter	Symbol	Rating	Unit
Supply Voltage	V <sub>IN</sub>	-0.3 to +30	V
EN Input Voltage	V <sub>EN</sub>	-0.3 to V <sub>IN</sub>	V
Voltage from GND to BOOT	V <sub>BOOT</sub>	-0.3 to +35	V
Voltage from SW to BOOT	ΔV <sub>BOOT</sub>	-0.3 to +7	V
FB Input Voltage	V <sub>FB</sub>	-0.3 to +7	V
COMP Input Voltage	V <sub>COMP</sub>	-0.3 to +7	V
SW Input Voltage	V <sub>SW</sub>	-0.5 to V <sub>IN</sub> +0.3	V
Operating Ambient Temperature Range	Topr	-40 to +85	°C
Storage Temperature Range	Tstg	-55 to +150	°C

**Caution1:** Operating the IC over the absolute maximum ratings may damage the IC. The damage can either be a short circuit between pins or an open circuit between pins and the internal circuitry. Therefore, it is important to consider circuit protection measures, such as adding a fuse, in case the IC is operated over the absolute maximum ratings.

Thermal Resistance<sup>(Note 1)</sup>

Parameter	Symbol	Thermal Resistance (Typ)		Unit
		1s <sup>(Note 3)</sup>	2s2p <sup>(Note 4)</sup>	
HTSOP-J8				
Junction to Ambient	θ <sub>JA</sub>	206.4	45.2	°C/W
Junction to Top Characterization Parameter <sup>(Note 2)</sup>	Ψ <sub>JT</sub>	21	13	°C/W

(Note 1)Based on JESD51-2A(Still-Air)

(Note 2)The thermal characterization parameter to report the difference between junction temperature and the temperature at the top center of the outside surface of the component package.

(Note 3)Using a PCB board based on JESD51-3.

Layer Number of Measurement Board	Material	Board Size
Single	FR-4	114.3mm x 76.2mm x 1.57mmt
Top		
Copper Pattern	Thickness	
Footprints and Traces	70μm	

(Note 4)Using a PCB board based on JESD51-5, 7.

Layer Number of Measurement Board	Material	Board Size	Thermal Via <sup>(NOTE 5)</sup>		
			Pitch	Diameter	
4 Layers	FR-4	114.3mm x 76.2mm x 1.6mmt	1.20mm	Φ0.30mm	
Top		2 Internal Layers		Bottom	
Copper Pattern	Thickness	Copper Pattern	Thickness	Copper Pattern	Thickness
Footprints and Traces	70μm	74.2mm x 74.2mm	35μm	74.2mm x 74.2mm	70μm

(Note 5) This thermal via connects with the copper pattern of all layers..

### ● Recommended Operating Ratings

Parameter	Symbol	Rating			Unit
		Min	Typ	Max	
Supply Voltage	V <sub>IN</sub>	7.0	-	28	V
Output Current	I <sub>OUT</sub>	0	-	3.0	A
Output Voltage Range	V <sub>RANGE</sub>	1.0 <sup>(Note 1)</sup>	-	V <sub>IN</sub> × 0.7	V

(Note 1) Please use it in I/O voltage setting of which output pulse width does not become 200nsec (Typ) or less.(The output voltage set method, please refer to Page 30.)

### ● Electrical Characteristics(T<sub>a</sub> = 25°C, V<sub>IN</sub> 12 V, V<sub>EN</sub> = 3 V unless otherwise specified)

Parameter	Symbol	Limits			Unit	Conditions
		Min	Typ	Max		
Supply Current in Operating	I <sub>OPR</sub>	-	290	580	μA	V <sub>FB</sub> = 0.9V No switching
Supply Current in Standby	I <sub>STBY</sub>	-	0	10	μA	V <sub>EN</sub> = 0V
Reference Voltage	V <sub>FB</sub>	0.792	0.800	0.808	V	
FB Input Current	I <sub>FB</sub>	-1	0	1	μA	V <sub>FB</sub> = 0.8V
Switching frequency	F <sub>OSC</sub>	484	550	616	kHz	
High-side FET on-resistance	R <sub>ONH</sub>	-	90	-	mΩ	I <sub>SW</sub> = 100mA
Low-side FET on-resistance	R <sub>ONL</sub>	-	70	-	mΩ	I <sub>SW</sub> = 100mA
Over Current limit	I <sub>LIMIT</sub>	-	5.2	-	A	
UVLO detection voltage	V <sub>UVLO</sub>	6.0	6.4	6.7	V	V <sub>IN</sub> falling
UVLO hysteresis voltage	V <sub>UVLOHYS</sub>	100	200	300	mV	
EN high-level input voltage	V <sub>ENH</sub>	2.5	-	V <sub>IN</sub>	V	
EN low-level input voltage	V <sub>ENL</sub>	0	-	0.8	V	
EN Input current	I <sub>EN</sub>	2	4	8	μA	V <sub>EN</sub> = 3V
Soft Start time	T <sub>SS</sub>	1.2	2.5	5.0	msec	

● V<sub>FB</sub> : FB Input Voltage. V<sub>EN</sub> : EN Input Voltage.

● Typical Performance Curves

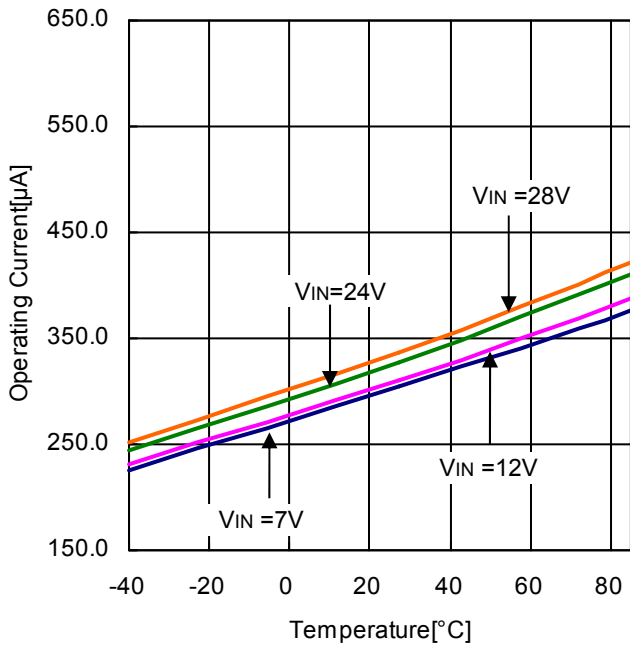

Figure 4. Operating Current - Temperature

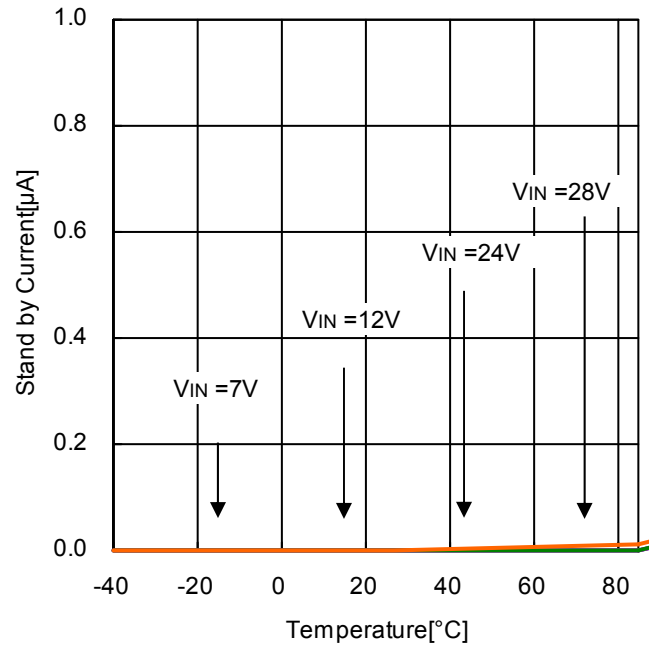

Figure 5. Stand-by Current - Temperature

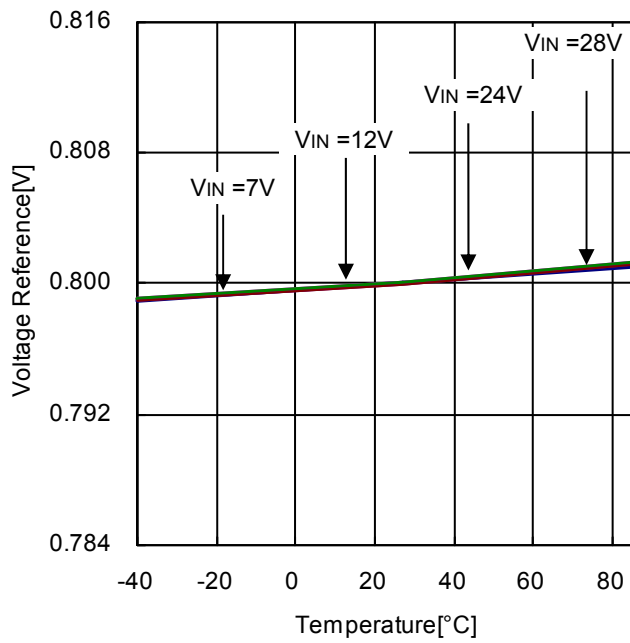

Figure 6. FB Voltage Reference - Temperature

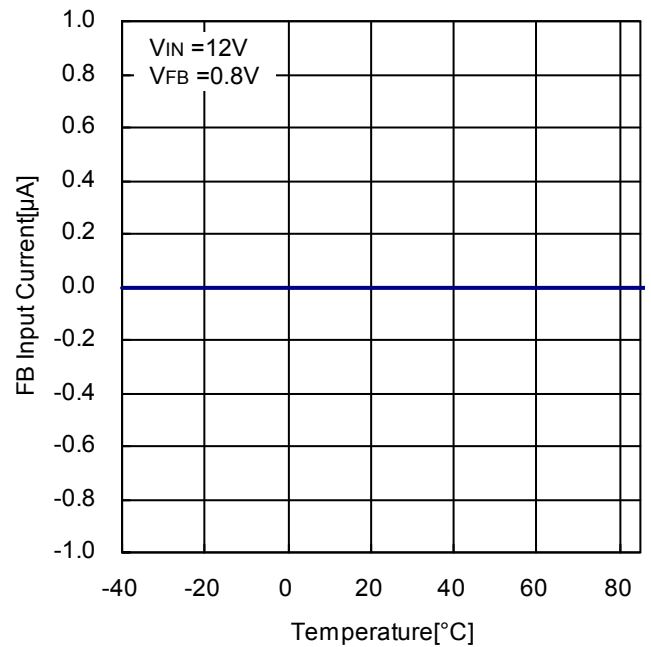

Figure 7. FB Input Current - Temperature

Typical Performance Curves -continued

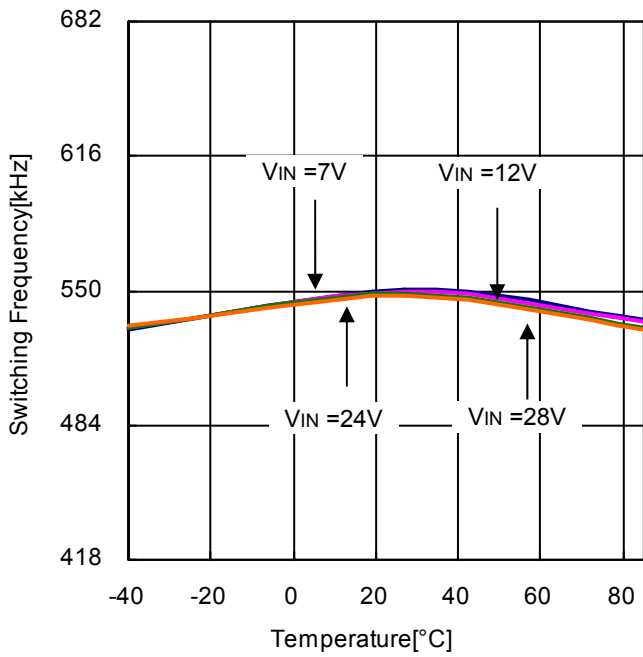

Figure 8. Switching Frequency - Temperature

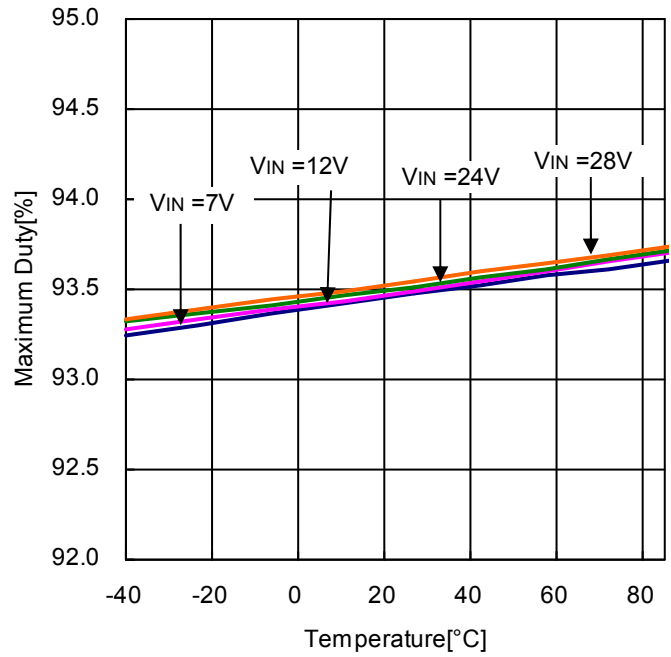

Figure 9. Maximum Duty - Temperature

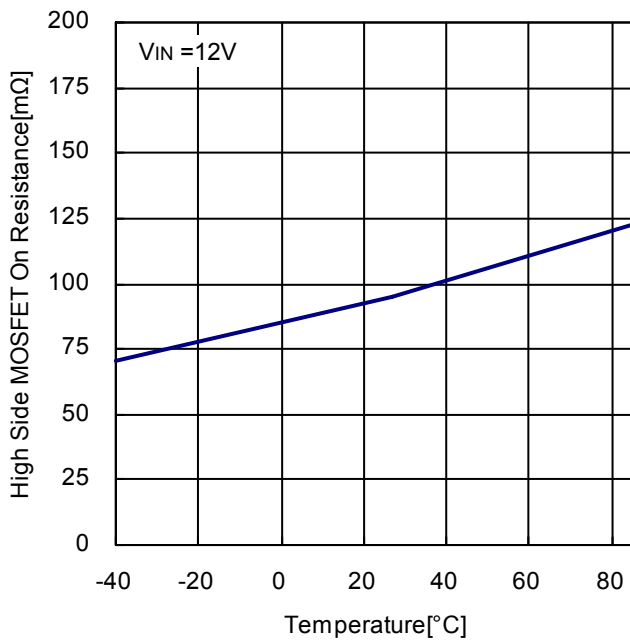

Figure 10. High Side MOSFET On-Resistance- Temperature

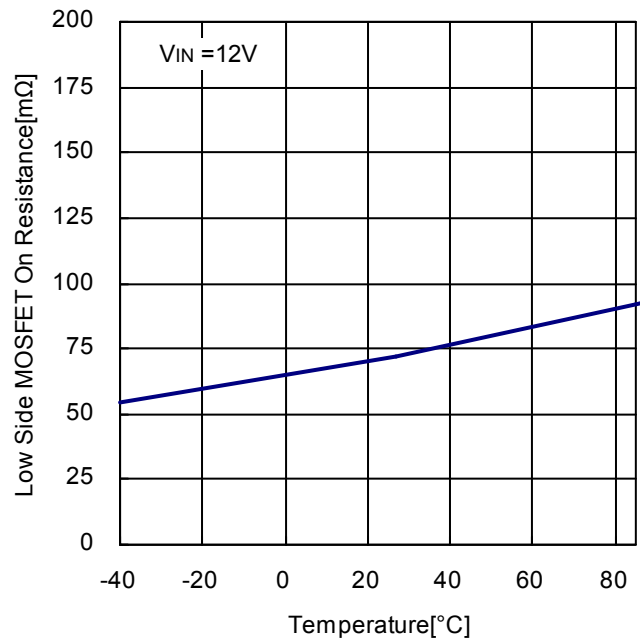

Figure 11. Low Side MOSFET On-Resistance- Temperature



Typical Performance Curves -continued

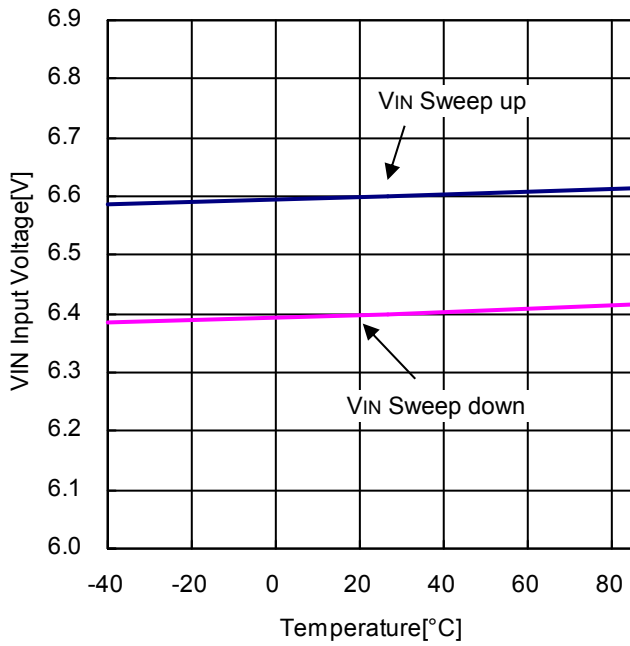

Figure 12. UVLO Threshold - Temperature

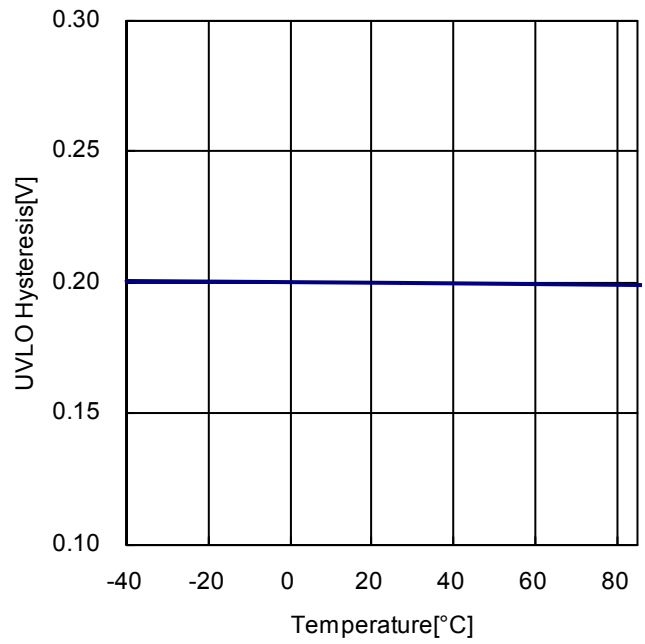

Figure 13. UVLO Hysteresis- Temperature

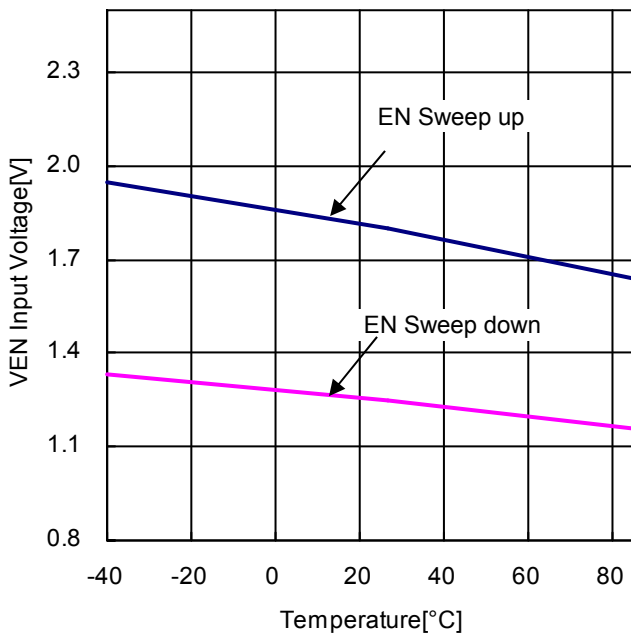

Figure 14. EN Threshold - Temperature

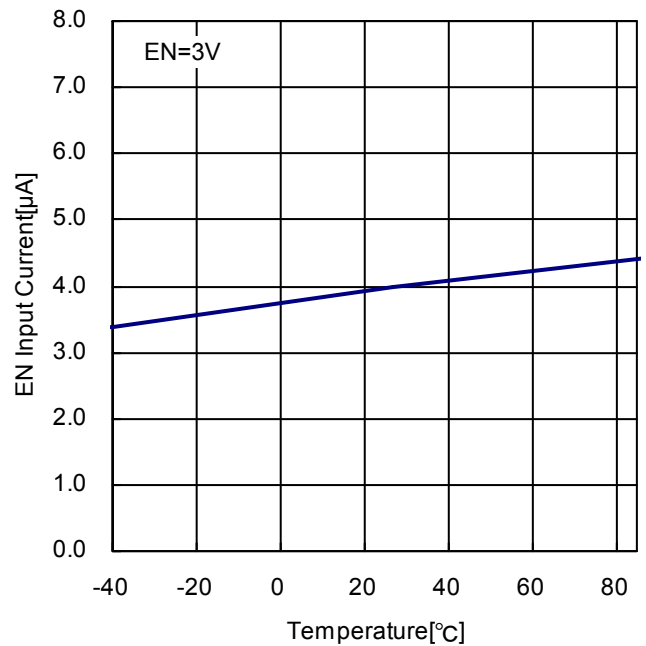

Figure 15. EN Input Current - Temperature

## Typical Performance Curves -continued

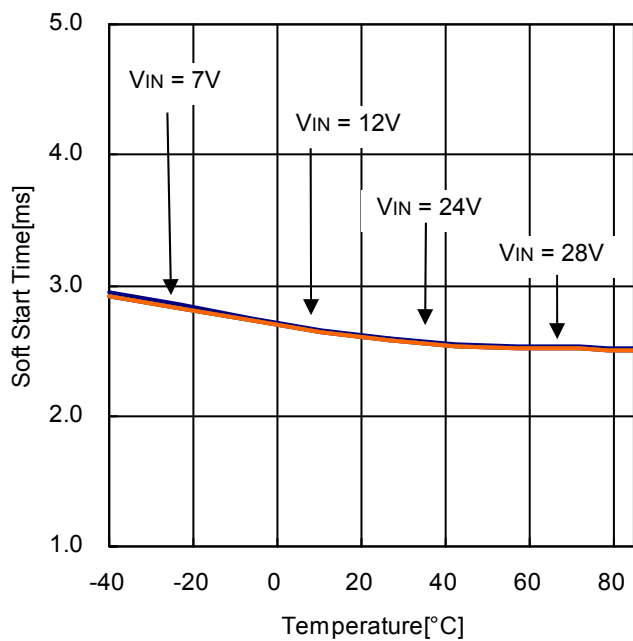

Figure 16. Soft Start Time - Temperature

Typical Performance Curves (Application)

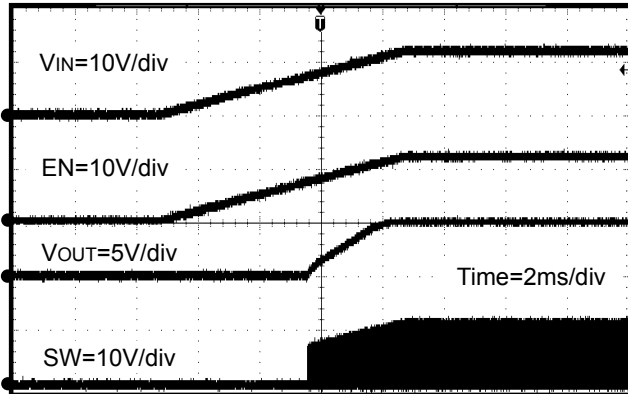

Figure 17. Power Up (VIN = EN)

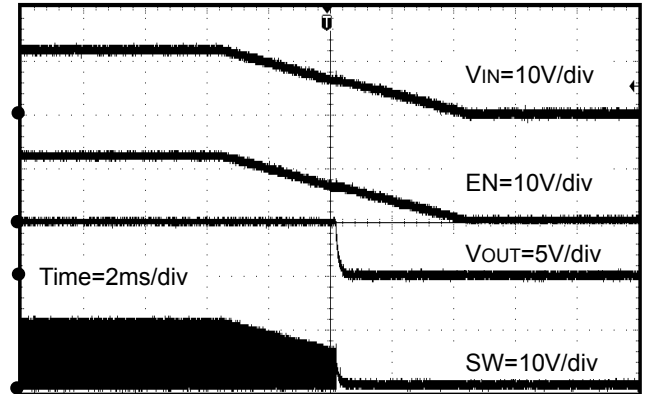

Figure 18. Power Down (VIN = EN)

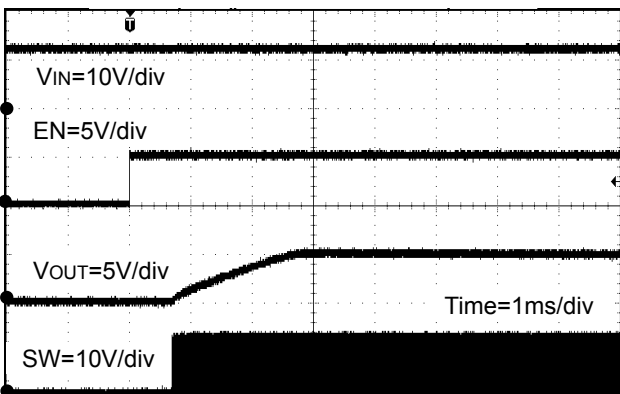

Figure 19. Power Up (EN = 0V→5V, Io=3A)

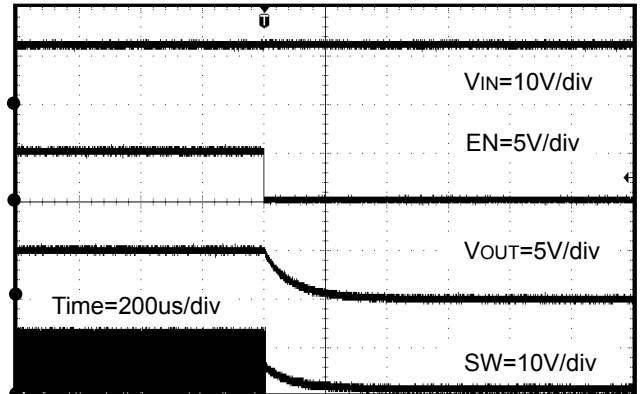

Figure 20. Power Down (EN = 5V→0V, Io=3A)

Typical Performance Curves (Application)-continue

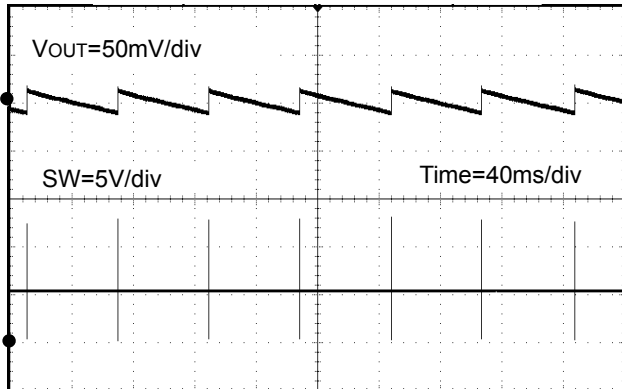

Figure 21. Vout Ripple  
(VIN = 12V, VOUT = 5V, IOUT = 0A)

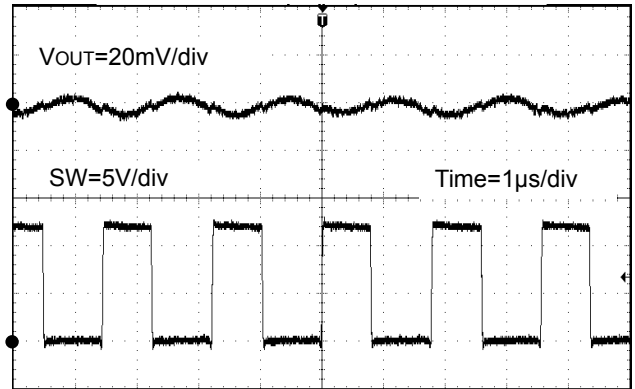

Figure 22. Vout Ripple  
(VIN = 12V, VOUT = 5V, IOUT = 3A)

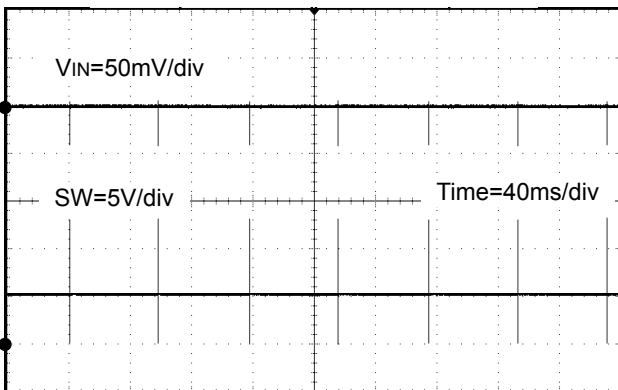

Figure 23. VIN Ripple  
(VIN = 12V, VOUT = 5V, IOUT = 0A)

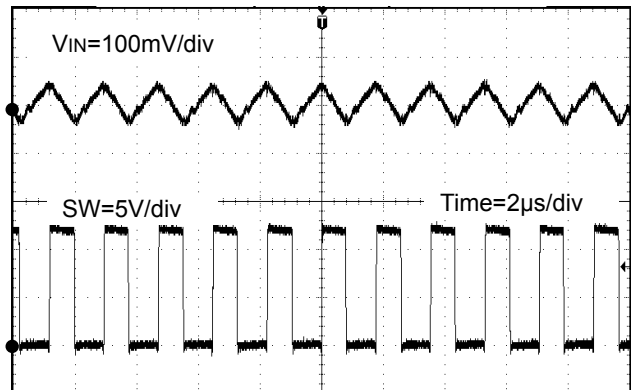

Figure 24. VIN Ripple  
(VIN = 12V, VOUT = 5V, IOUT = 3A)

Typical Performance Curves (Application)-continue

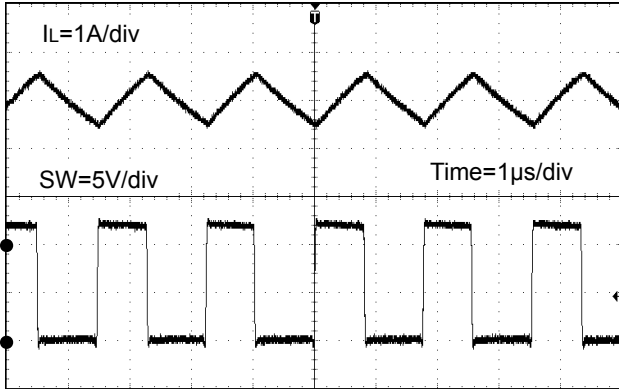

Figure 25. Switching Waveform  
( $V_{IN} = 12V$ ,  $V_{OUT} = 5V$ ,  $I_{OUT} = 3A$ )

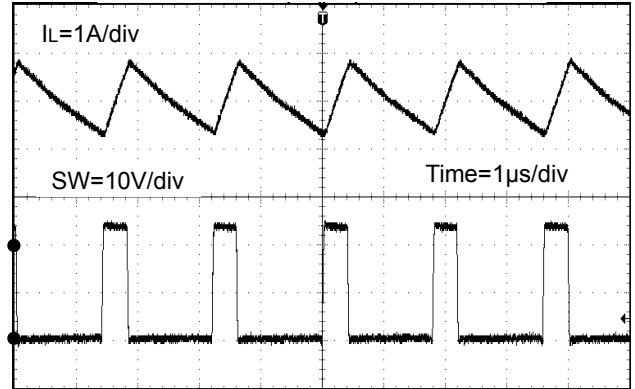

Figure 26. Switching Waveform  
( $V_{IN} = 24V$ ,  $V_{OUT} = 5V$ ,  $I_{OUT} = 3A$ )

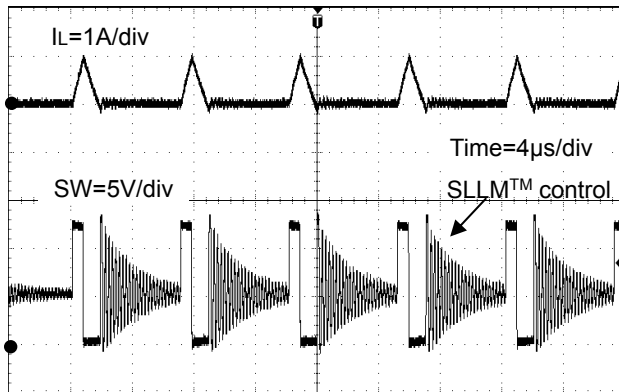

Figure 27. Switching Waveform  
( $V_{IN} = 12V$ ,  $V_{OUT} = 5V$ ,  $I_{OUT} = 50mA$ )

Typical Performance Curves (Application)-continue

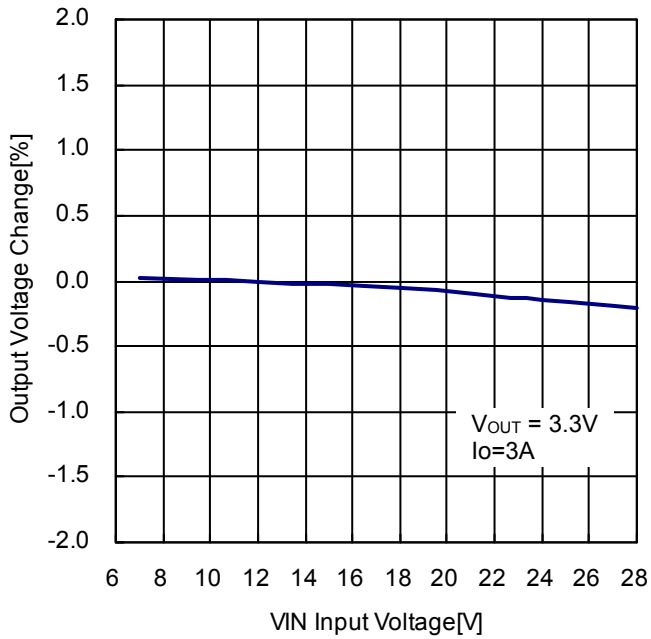

Figure 28. VOUT Line Regulation (VOUT = 3.3V)

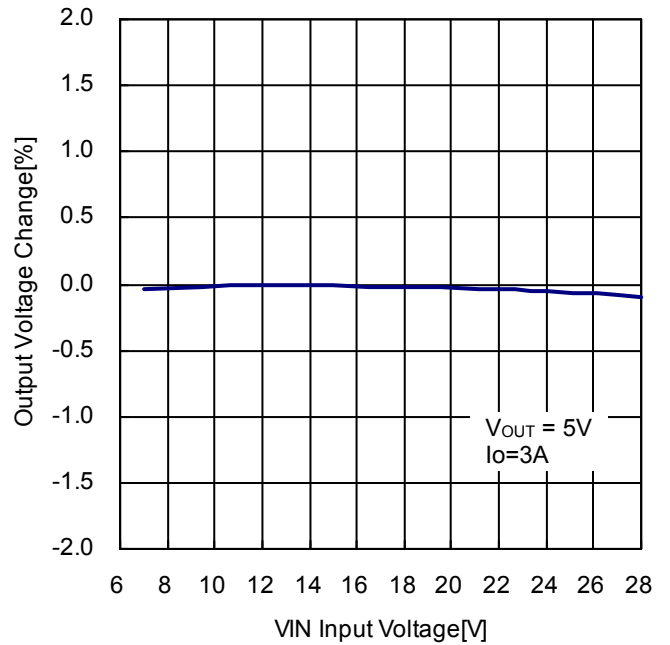

Figure 29. VOUT Line Regulation (VOUT = 5V)

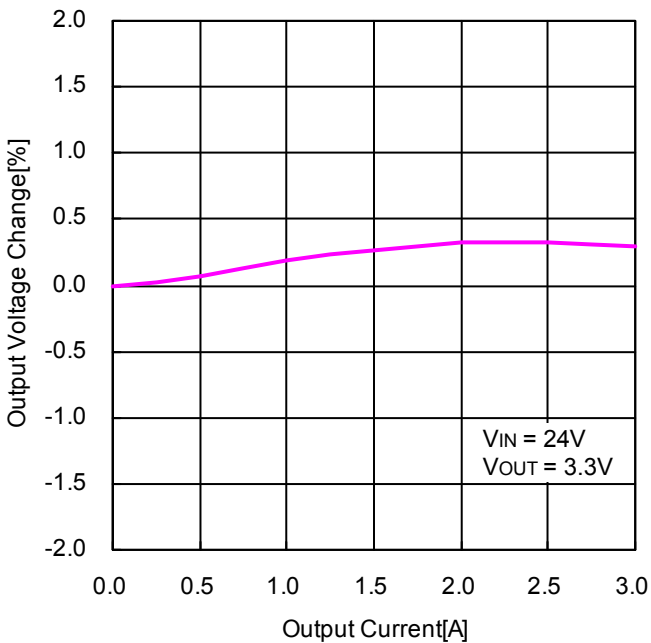

Figure 30. VOUT Load Regulation (VOUT = 3.3V)

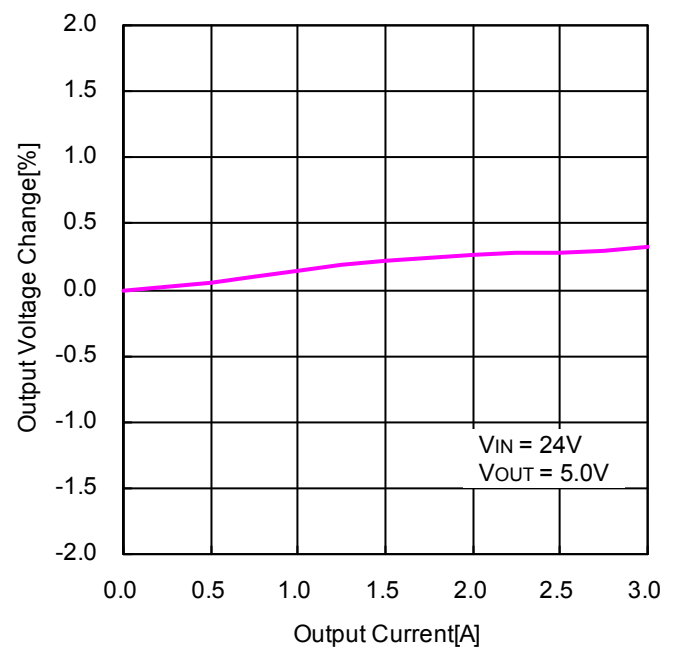

Figure 31. VOUT Load Regulation (VOUT = 5V)

● Function Description

1) DC/DC converter operation

BD9E302EFJ is a synchronous rectifying step-down switching regulator that achieves faster transient response by employing current mode PWM control system. It utilizes switching operation in PWM (Pulse Width Modulation) mode for heavier load, while it utilizes SLLM (Simple Light Load Mode) control for lighter load to improve efficiency.

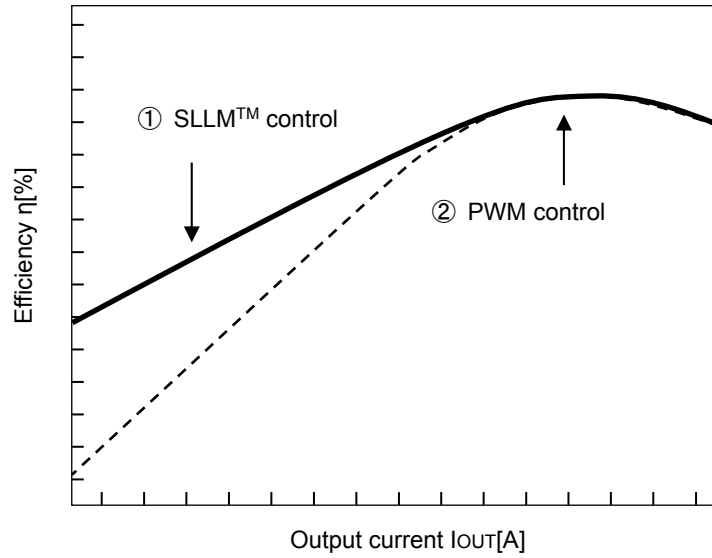

Figure 32. Efficiency (SLLM™ control and PWM control)

①SLLM™ control

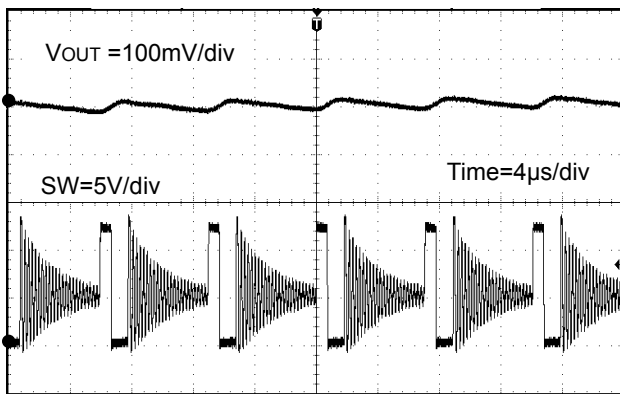

Figure 33. SW Waveform (①SLLM™ control)  
( $V_{in} = 12V$ ,  $V_{out} = 5.0V$ ,  $I_{out} = 50mA$ )

②PWM control

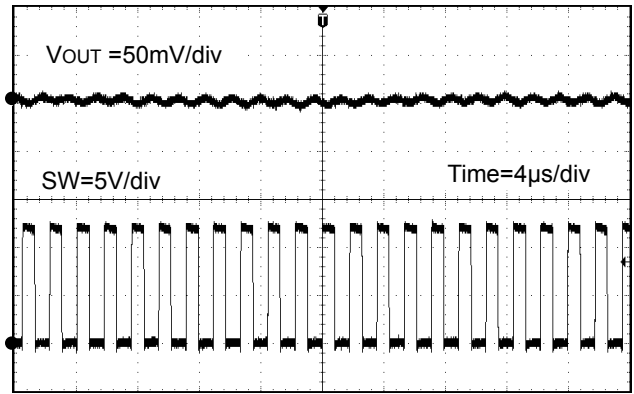

Figure 34. SW Waveform (②PWM control)  
( $V_{in} = 12V$ ,  $V_{out} = 5.0V$ ,  $I_{out} = 3A$ )

2) Enable Control

The IC shutdown can be controlled by the voltage applied to the EN terminal. When EN voltage reaches 2.5 V, the internal circuit is activated and the IC starts up. To enable shutdown control with the EN terminal, set the shutdown interval (Low level interval of EN) must be set to 100 μs or longer.

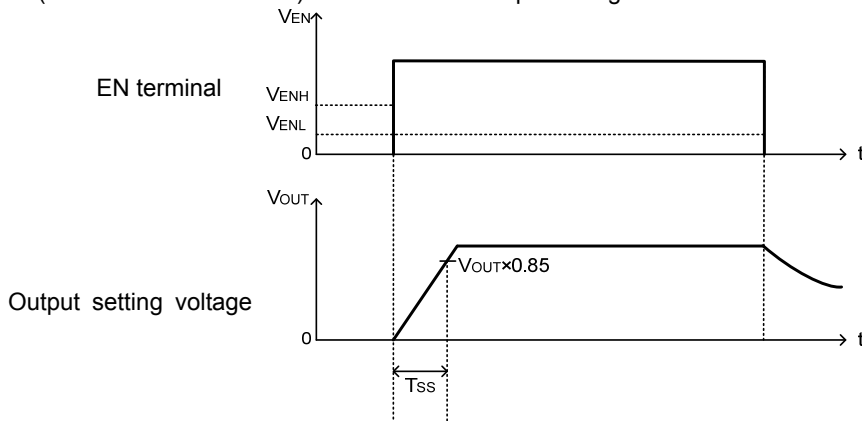

Figure 35. Timing Chart with Enable Control

3) Protective Functions

The protective circuits are intended for prevention of damage caused by unexpected accidents. Do not use them for continuous protective operation.

3-1) Short Circuit Protection (SCP)

The short circuit protection block compares the FB terminal voltage with the internal reference voltage VREF. When the FB terminal voltage has fallen below 0.56 V (Typ) and remained there for 0.9 msec (Typ), SCP stops the operation for 14.4 msec (Typ) and subsequently initiates a restart.

Table 1. Short Circuit Protection Function

EN pin	FB pin	Short Circuit Protection	Switching Frequency
2.5 V or higher	$0.30V (Typ) \geq FB$	Enabled	137.5kHz (Typ)
	$0.30V (Typ) < FB \leq 0.56V (Typ)$		275kHz (Typ)
	$FB > 0.56V (Typ)$		550kHz (Typ)
0.8 V or lower	-	Disabled	OFF

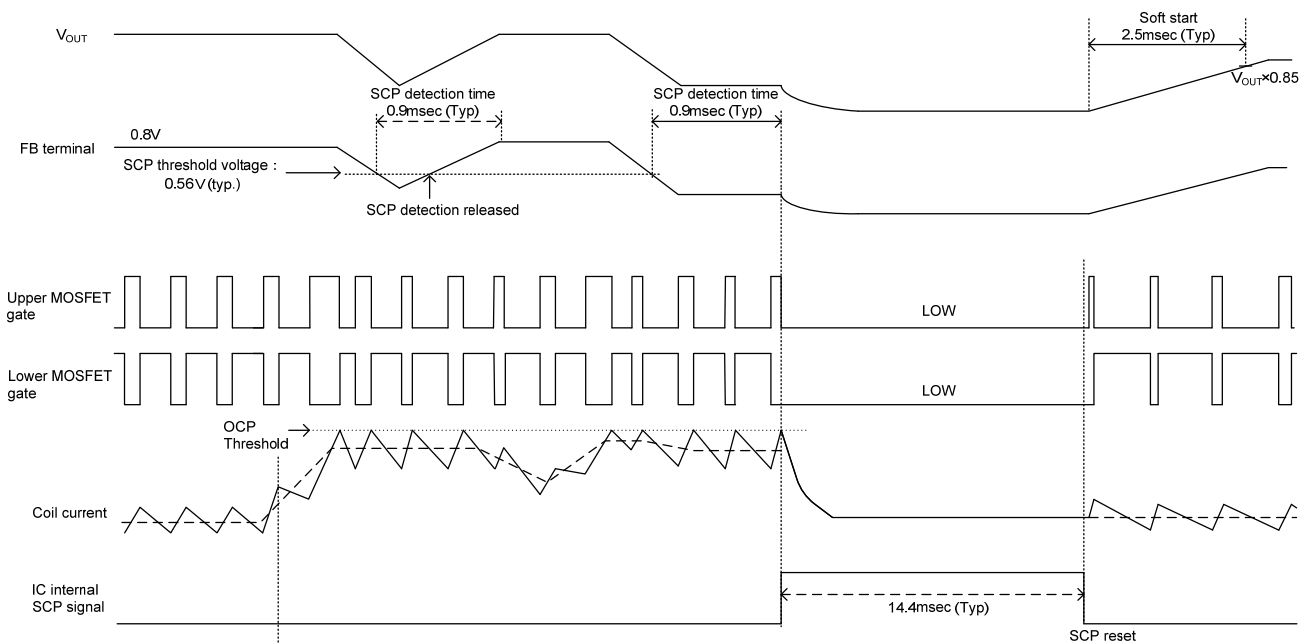

Figure 36. Short circuit protection function (SCP) timing chart



**3-2) Under Voltage Lockout Protection (UVLO)**

The under voltage lockout protection circuit monitors the  $V_{IN}$  terminal voltage. The operation enters standby when the  $V_{IN}$  terminal voltage is 6.4 V (Typ) or lower. The operation starts when the  $V_{IN}$  terminal voltage is 6.6 V (Typ) or higher.

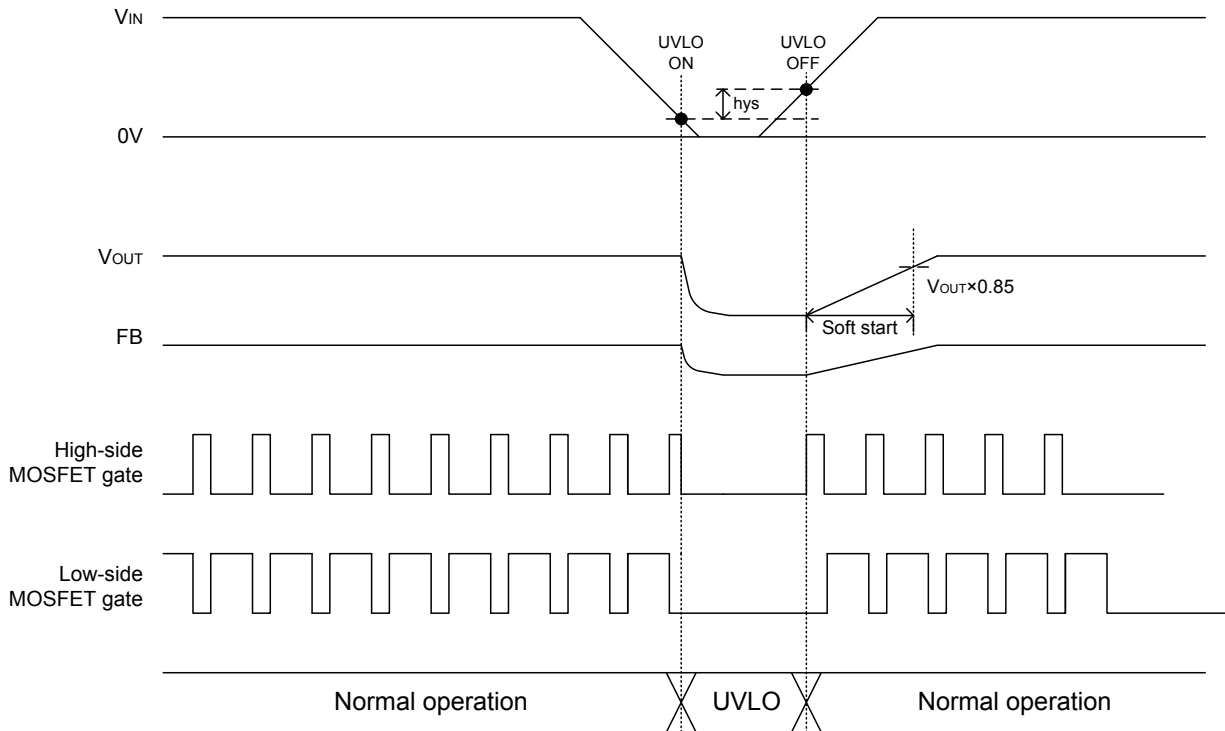

Figure 37. UVLO Timing Chart

**3-3) Thermal Shutdown Function (TSD)**

This is thermal shutdown block. Usually IC operating in the allowable power dissipation, but when the IC power dissipation more than rating value,  $T_j$  will increase, when the chip temperature exceeds 175°C(Typ), The thermal shutdown circuit is intended to shut down internal power devices. Then the  $T_j$  will decreased and IC restart. It is not meant to protect or guarantee the soundness of the application. Do not use the function of this circuit for application protection design.

**3-4) Over Current Protection Function (OCP)**

The overcurrent protection function is realized by using the current mode control to limit the current that flows through the high-side MOSFET at each cycle of the switching frequency.

**3-5) Over Voltage Protection Function (OVP)**

Over voltage protection function (OVP) compares FB terminal voltage with internal standard voltage  $V_{REF}$  and when FB terminal voltage exceeds 1.04V (Typ) it turns MOSFET of output part MOSFET OFF. After output voltage drop it returns with hysteresis.

● Application Example 1

Parameter	Symbol	Value Example
Input Voltage	$V_{IN}$	12/24 V
Output Voltage	$V_{OUT}$	5 V
Switching Frequency	$F_{OSC}$	550kHz(Typ)
Maximum Output Current	$I_{OMAX}$	3A
Operating Ambient Temperature Range	$Topr$	-40 °C ~ +85°C

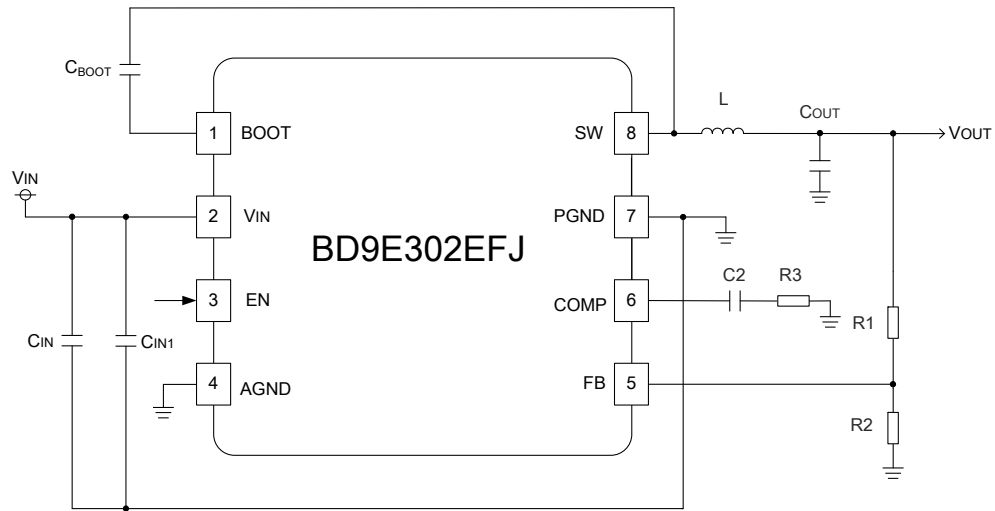

Figure 38. Application Circuit 1

Table 2. Recommendation Circuit constants

Reference Designator	Configuration (mm)	Specification	Part Number	Type	Manufacturer
R1	1005	430 kΩ, 1 %, 1 / 16 W	MCR01MZPF4303	Chip resistor	ROHM
R2	1005	82 kΩ, 1 %, 1 / 16 W	MCR01MZPF8202	Chip resistor	ROHM
R3	1005	10 kΩ, 5 %, 1 / 16 W	MCR01MZPJ103	Chip resistor	ROHM
C2	1005	6800 pF R, 50 V	GRM series	Ceramic capacitor	MURATA
CBOOT	1608	0.1 μF, B, 50 V	GRM series	Ceramic capacitor	MURATA
CIN1 <sup>(Note 1)</sup>	1608	0.1 μF, B, 50 V	GRM series	Ceramic capacitor	MURATA
CIN <sup>(Note 2)</sup>	3225	10 μF, B, 50 V	GRM series	Ceramic capacitor	MURATA
COUT <sup>(Note 3)</sup>	3225	22 μF B, 25 V × 2	GRM series	Ceramic capacitor	MURATA
L	7269	4.7μH	CLF7045NIT-4R7N	Inductor	TDK

(Note 1) In order to reduce the influence of high frequency noise, arrange the 0.1μF ceramic capacitor as close as possible to the VIN pin.

(Note 2) For capacitance of input capacitor, take temperature characteristics, DC bias characteristics, etc. into consideration to set minimum value to no less than 4.7μF.

(Note 3) In case capacitance value fluctuates due to temperature characteristics, DC bias characteristics, etc. of output capacitor, crossover frequency may fluctuate. When selecting a capacitor, confirm the characteristics of the capacitor in its datasheet. Also, Please use capacitors such as ceramic type are recommended for output capacitor.

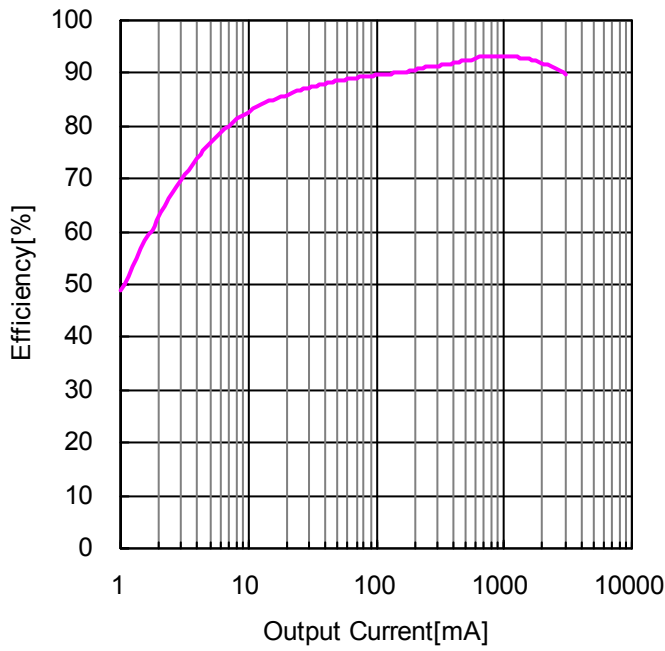

Figure 39. Efficiency - Output Current  
( $V_{IN}=12V$ ,  $V_{OUT} = 5.0V$ ,  $R3=10k\Omega$ )

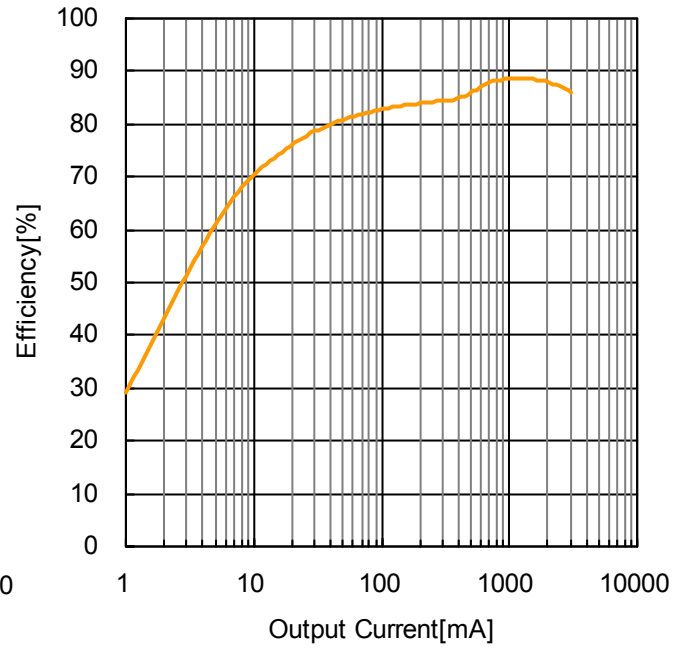

Figure 40. Efficiency - Output Current  
( $V_{IN}=24V$ ,  $V_{OUT} = 5.0V$ ,  $R3=10k\Omega$ )

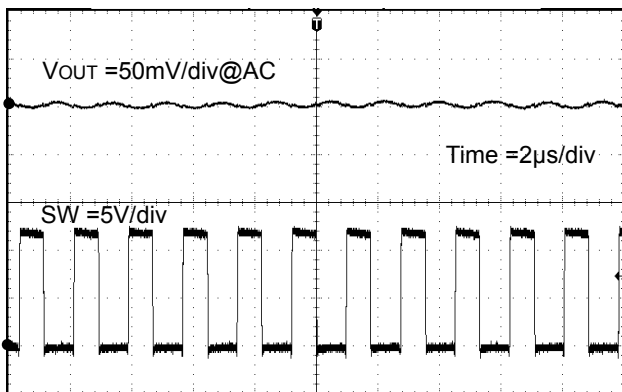

Figure 41. VOUT Ripple  
( $V_{IN} = 12V$ ,  $V_{OUT} = 5V$ ,  $R3=10k\Omega$ )

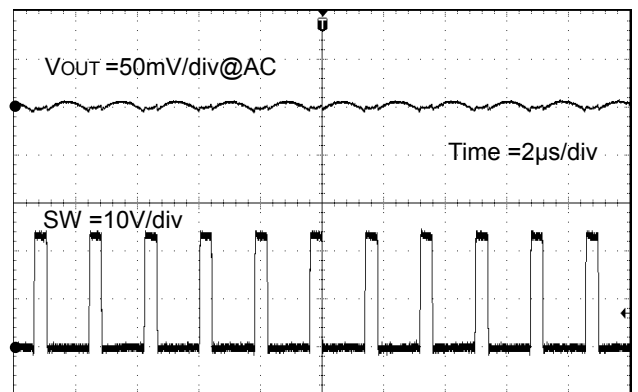

Figure 42. VOUT Ripple  
( $V_{IN} = 24V$ ,  $V_{OUT} = 5V$ ,  $R3=10k\Omega$ )

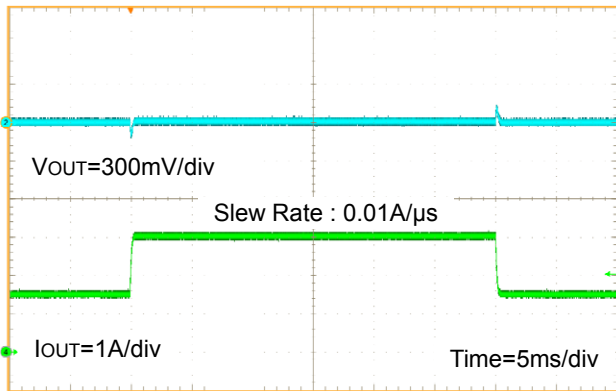

Figure 43. Load Transient Response  $I_{OUT}=1.5A - 3A$   
( $V_{IN}=12V, V_{OUT}=5V, R_3=10k\Omega$ )

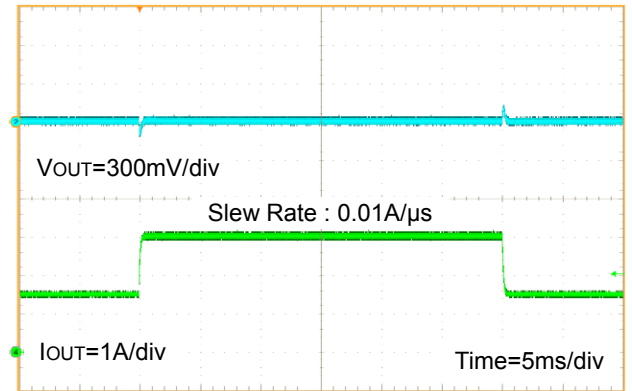

Figure 44. Load Transient Response  $I_{OUT}=1.5A - 3A$   
( $V_{IN}=24V, V_{OUT}=5V, R_3=10k\Omega$ )

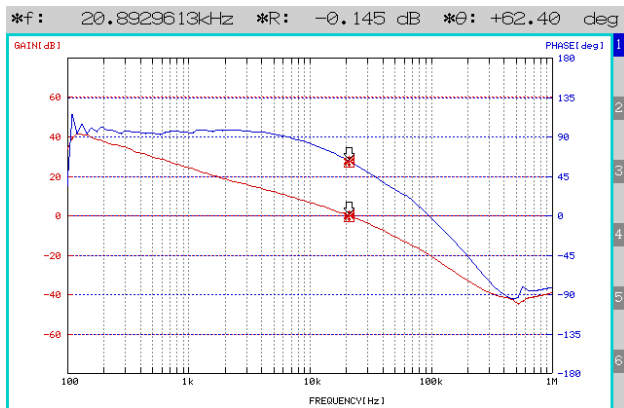

Figure 45. Loop Response  $I_{OUT}=3A$   
( $V_{IN}=12V, V_{OUT}=5V, R_3=10k\Omega$ )

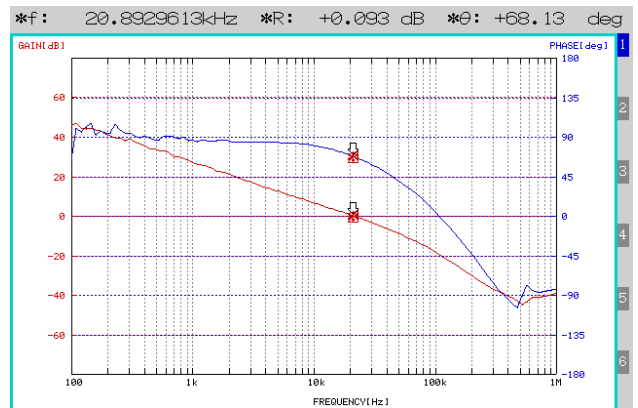

Figure 46. Loop Response  $I_{OUT}=3A$   
( $V_{IN}=24V, V_{OUT}=5V, R_3=10k\Omega$ )

● Application Example 2 (Fast load response)

Parameter	Symbol	Value Example
Input Voltage	$V_{IN}$	12/24 V
Output Voltage	$V_{OUT}$	5 V
Switching Frequency	$F_{OSC}$	550kHz(Typ)
Maximum Output Current	$I_{OMAX}$	3A
Operating Ambient Temperature Range	$Topr$	-40 °C ~ +85°C

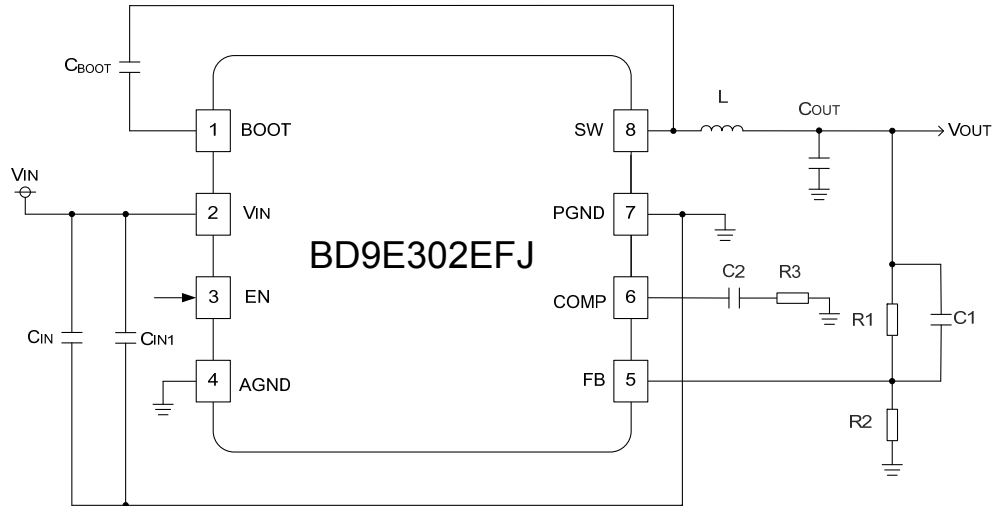

Figure 47. Application Circuit 2

Table 3. Recommendation Circuit constants

Reference Designator	Configuration (mm)	Specification	Part Number	Type	Manufacturer
R1	1005	430 kΩ, 1 %, 1 / 16 W	MCR01MZPF4303	Chip resistor	ROHM
R2	1005	82 kΩ, 1 %, 1 / 16 W	MCR01MZPF8202	Chip resistor	ROHM
R3	1005	15 kΩ, 5 %, 1 / 16 W	MCR01MZPJ153	Chip resistor	ROHM
C1	1005	18 pF CH, 50 V	GRM series	Ceramic capacitor	MURATA
C2	1005	6800 pF R, 50 V	GRM series	Ceramic capacitor	MURATA
C <sub>BOOT</sub>	1608	0.1 μF, B, 50 V	GRM series	Ceramic capacitor	MURATA
C <sub>IN1</sub> (Note 1)	1608	0.1 μF, B, 50 V	GRM series	Ceramic capacitor	MURATA
C <sub>IN</sub> (Note 2)	3225	10 μF, B, 50 V	GRM series	Ceramic capacitor	MURATA
C <sub>OUT</sub> (Note 3)	3225	22 μF B, 25 V × 2	GRM series	Ceramic capacitor	MURATA
L	7269	4.7μH	CLF7045NIT-4R7N	Inductor	TDK

- (Note 1) In order to reduce the influence of high frequency noise, arrange the 0.1μF ceramic capacitor as close as possible to the  $V_{IN}$  pin.
- (Note 2) For capacitance of input capacitor, take temperature characteristics, DC bias characteristics, etc. into consideration to set minimum value to no less than 4.7μF.
- (Note 3) In case capacitance value fluctuates due to temperature characteristics, DC bias characteristics, etc. of output capacitor, crossover frequency may fluctuate. When selecting a capacitor, confirm the characteristics of the capacitor in its datasheet. Also, Please use capacitors such as ceramic type are recommended for output capacitor.

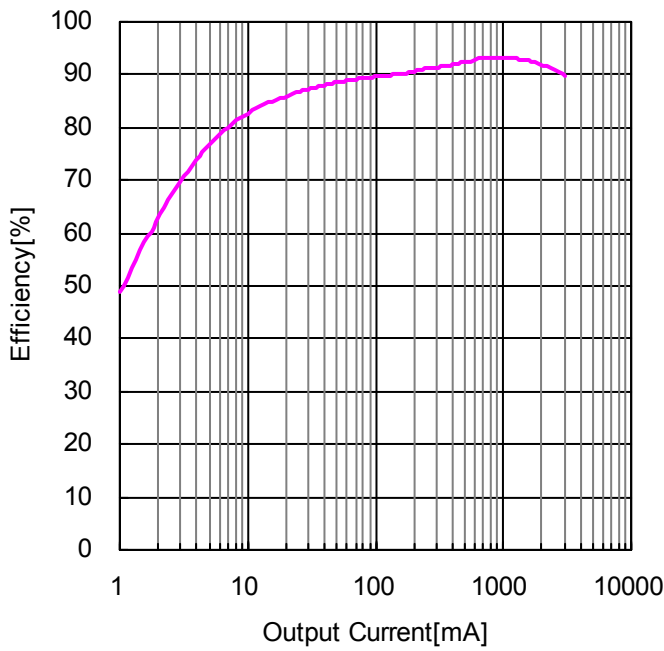

Figure 48. Efficiency - Output Current  
( $V_{IN}=12V$ ,  $V_{OUT} = 5.0V$ ,  $R_3=15k\Omega$ ,  $C_1=18pF$ )

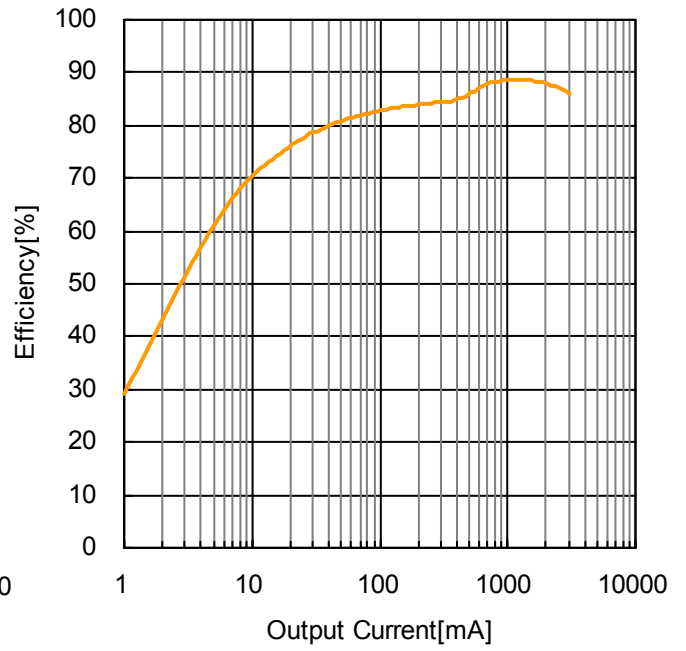

Figure 49. Efficiency - Output Current  
( $V_{IN}=24V$ ,  $V_{OUT} = 5.0V$ ,  $R_3=15k\Omega$ ,  $C_1=18pF$ )

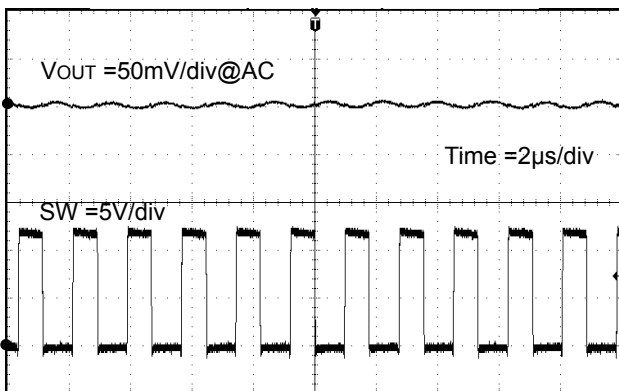

Figure 50. VOUT Ripple  
( $V_{IN} = 12V$ ,  $V_{OUT} = 5V$ ,  $R_3=15k\Omega$ ,  $C_1=18pF$ )

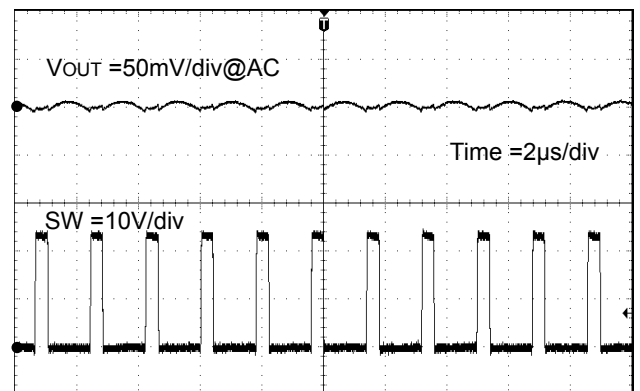

Figure 51. VOUT Ripple  
( $V_{IN} = 24V$ ,  $V_{OUT} = 5V$ ,  $R_3=15k\Omega$ ,  $C_1=18pF$ )

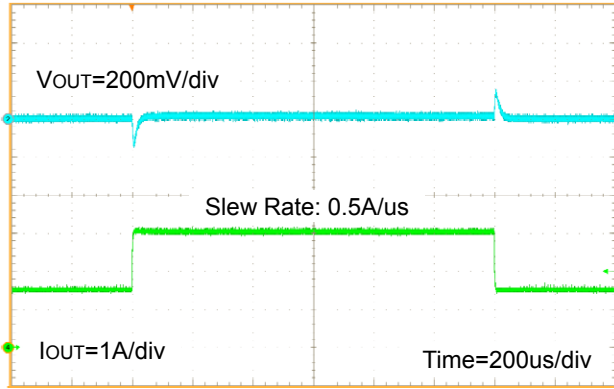

Figure 52. Load Transient Response  $I_{OUT}=1.5A - 3A$   
 ( $V_{IN}=12V, V_{OUT}=5V, R_3=15k\Omega, C_1=18pF$ )

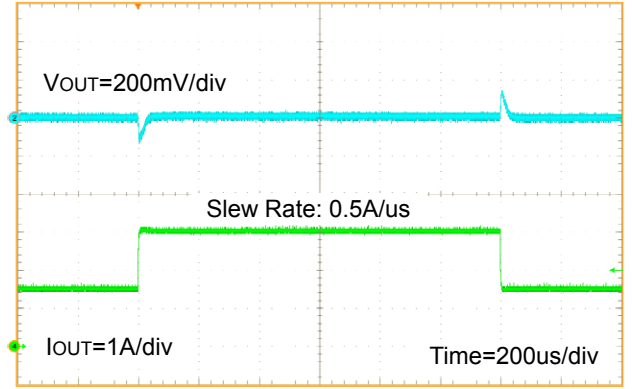

Figure 53. Load Transient Response  $I_{OUT}=1.5A - 3A$   
 ( $V_{IN}=24V, V_{OUT}=5V, R_3=15k\Omega, C_1=18pF$ )

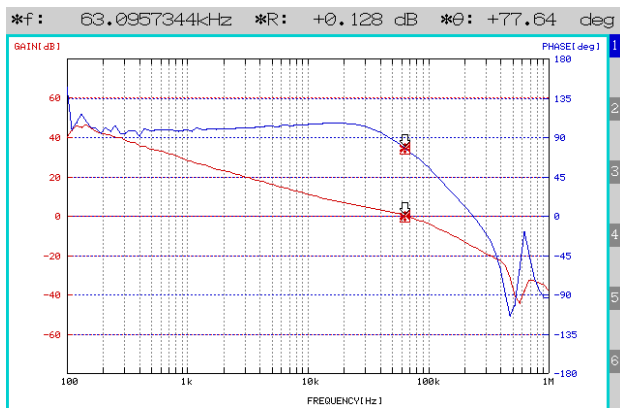

Figure 54. Loop Response  $I_{OUT}=3A$   
 ( $V_{IN}=12V, V_{OUT}=5V, R_3=15k\Omega, C_1=18pF$ )

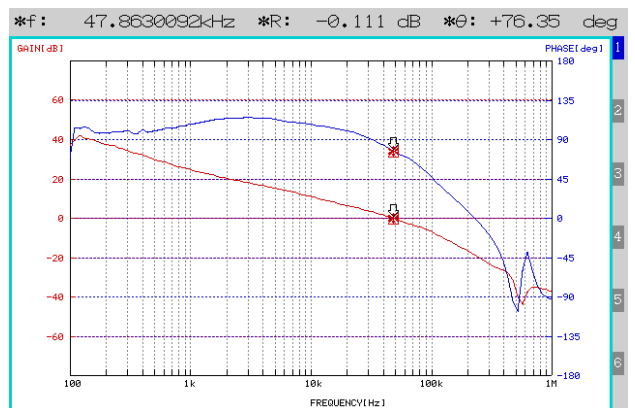

Figure 55. Loop Response  $I_{OUT}=3A$   
 ( $V_{IN}=24V, V_{OUT}=5V, R_3=15k\Omega, C_1=18pF$ )

● Application Example 3

Parameter	Symbol	Value Example
Input Voltage	$V_{IN}$	12/24 V
Output Voltage	$V_{OUT}$	3.3 V
Switching Frequency	$F_{OSC}$	550kHz(Typ)
Maximum Output Current	$I_{OMAX}$	3A
Operating Ambient Temperature Range	$Topr$	-40 °C ~ +85°C

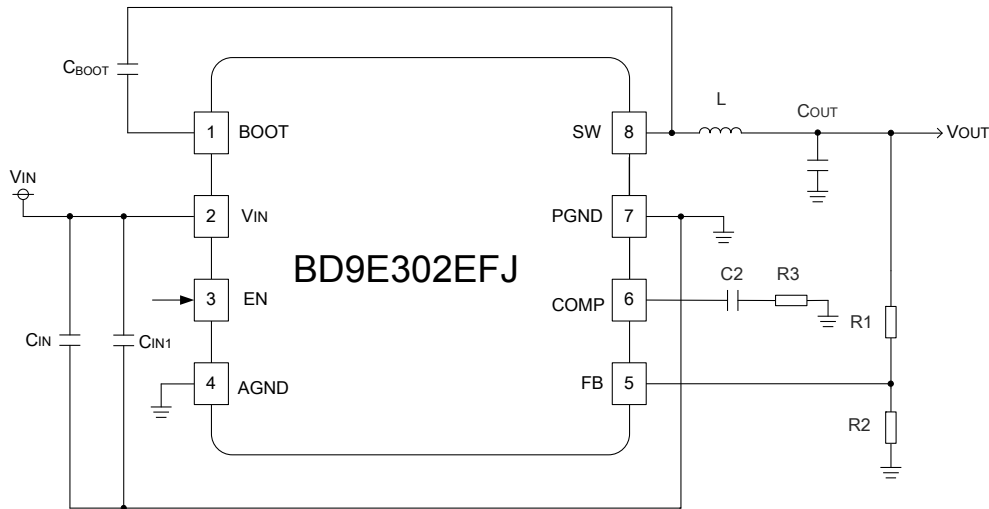

Figure 56. Application Circuit 3

Table 4. Recommendation Circuit constants

Reference Designator	Configuration (mm)	Specification	Part Number	Type	Manufacturer
R1	1005	75 kΩ, 1 %, 1 / 16 W	MCR01MZPF7502	Chip resistor	ROHM
R2	1005	24 kΩ, 1 %, 1 / 16 W	MCR01MZPF2402	Chip resistor	ROHM
R3	1005	6.8 kΩ, 5 %, 1 / 16 W	MCR01MZPJ682	Chip resistor	ROHM
C2	1005	6800 pF R, 50 V	GRM series	Ceramic capacitor	MURATA
CBOOT	1608	0.1 μF, B, 50 V	GRM series	Ceramic capacitor	MURATA
CIN1 <sup>(Note 1)</sup>	1608	0.1 μF, B, 50 V	GRM series	Ceramic capacitor	MURATA
CIN <sup>(Note 2)</sup>	3225	10 μF, B, 50 V	GRM series	Ceramic capacitor	MURATA
COUT <sup>(Note 3)</sup>	3225	22 μF B, 25 V × 2	GRM series	Ceramic capacitor	MURATA
L	7269	3.3μH	CLF7045NIT-3R3N	Inductor	TDK

(Note 1) In order to reduce the influence of high frequency noise, arrange the 0.1μF ceramic capacitor as close as possible to the VIN pin.

(Note 2) For capacitance of input capacitor, take temperature characteristics, DC bias characteristics, etc. into consideration to set minimum value to no less than 4.7μF.

(Note 3) In case capacitance value fluctuates due to temperature characteristics, DC bias characteristics, etc. of output capacitor, crossover frequency may fluctuate. When selecting a capacitor, confirm the characteristics of the capacitor in its datasheet. Also, Please use capacitors such as ceramic type are recommended for output capacitor.



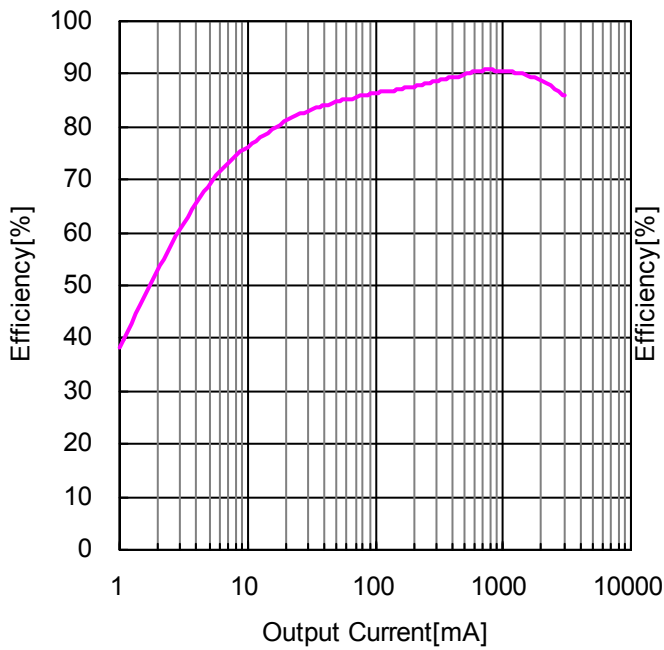

Figure 57. Efficiency - Output Current  
(VIN=12V, VOUT = 3.3V, R3=6.8kΩ)

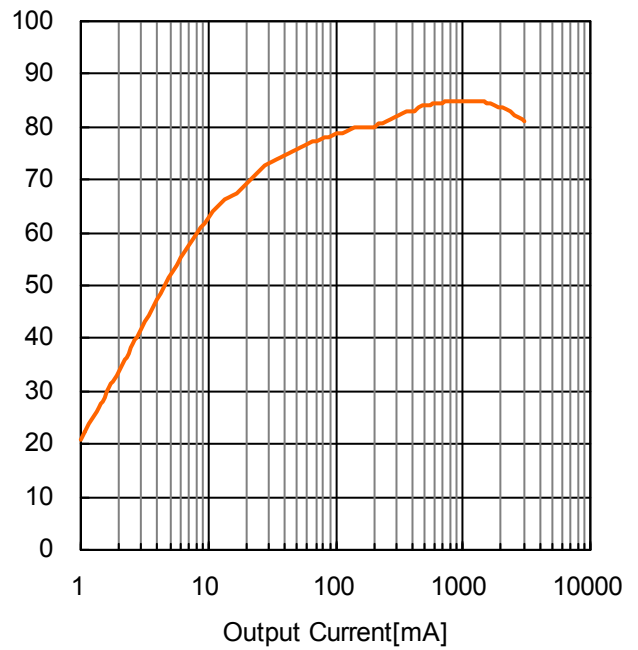

Figure 58. Efficiency - Output Current  
(VIN=24V, VOUT = 3.3V, R3=6.8kΩ)

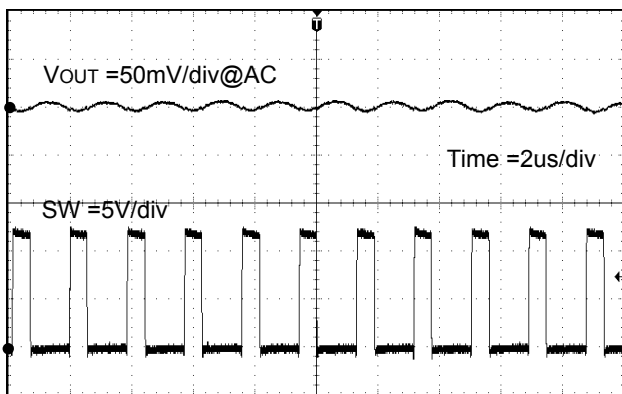

Figure 59. VOUT Ripple  
(VIN = 12V, VOUT = 3.3V, R3=6.8kΩ)

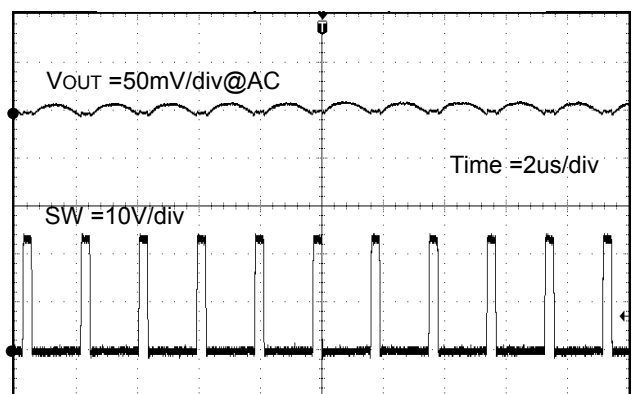

Figure 60. VOUT Ripple  
(VIN = 24V, VOUT = 3.3V, R3=6.8kΩ)

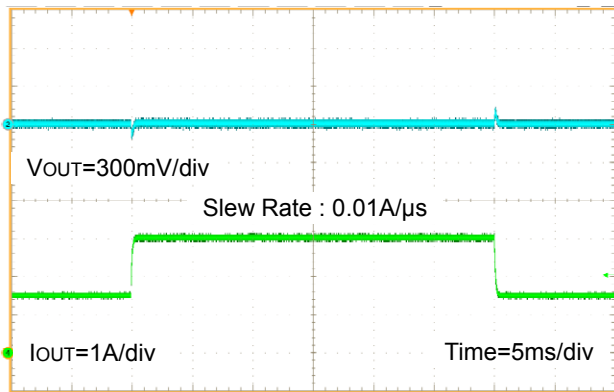

Figure 61. Load Transient Response IOUT=1.5A - 3A  
(VIN=12V, VOUT=3.3V, R3=6.8kΩ)

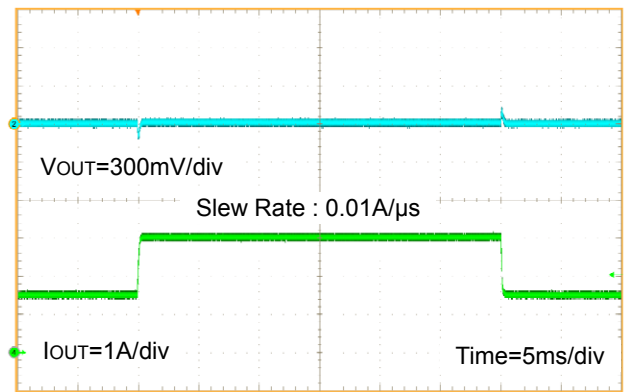

Figure 62. Load Transient Response IOUT=1.5A - 3A  
(VIN=24V, VOUT=3.3V, R3=6.8kΩ)

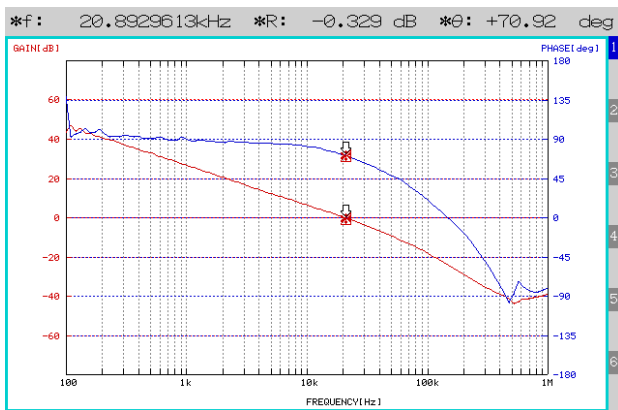

Figure 63. Loop Response IOUT=3A  
(VIN=12V, VOUT=3.3V, R3=6.8kΩ)

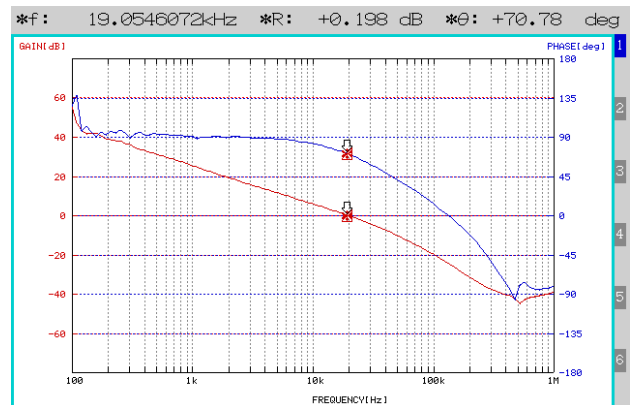

Figure 64. Loop Response IOUT=3A  
(VIN=24V, VOUT=3.3V, R3=6.8kΩ)

● Application Example 4 (Fast load response)

Parameter	Symbol	Value Example
Input Voltage	V <sub>IN</sub>	12/24 V
Output Voltage	V <sub>OUT</sub>	3.3 V
Switching Frequency	F <sub>OSC</sub>	550kHz(Typ)
Maximum Output Current	I <sub>OMAX</sub>	3A
Operating Ambient Temperature Range	Topr	-40 °C ~ +85°C

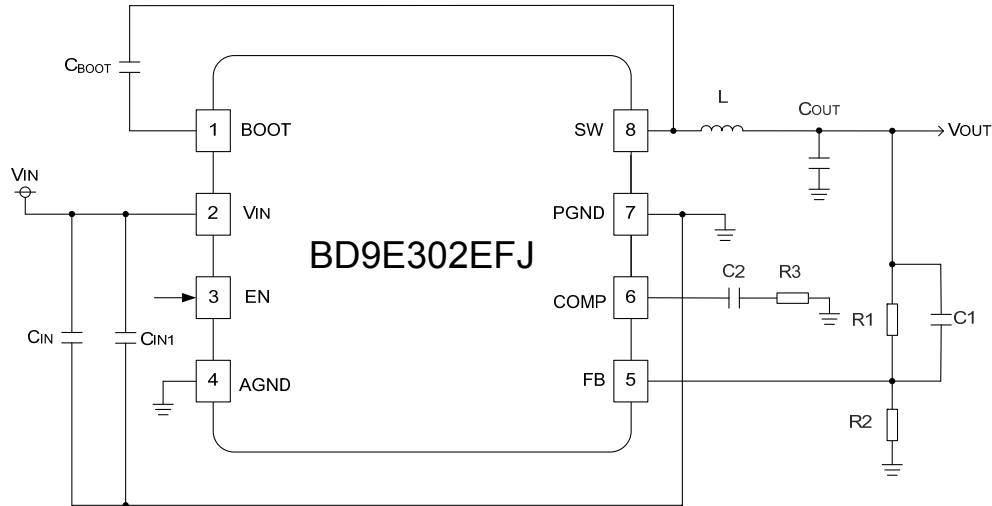

Figure 65. Application Circuit 4

Table 5. Recommendation Circuit constants

Reference Designator	Configuration (mm)	Specification	Part Number	Type	Manufacturer
R1	1005	75 kΩ, 1 %, 1 / 16 W	MCR01MZPF7502	Chip resistor	ROHM
R2	1005	24 kΩ, 1 %, 1 / 16 W	MCR01MZPF2402	Chip resistor	ROHM
R3	1005	10 kΩ, 5 %, 1 / 16 W	MCR01MZPJ103	Chip resistor	ROHM
C1	1005	100 pF CH, 50 V	GRM series	Ceramic capacitor	MURATA
C2	1005	6800 pF R, 50 V	GRM series	Ceramic capacitor	MURATA
C <sub>BOOT</sub>	1608	0.1 μF, B, 50 V	GRM series	Ceramic capacitor	MURATA
C <sub>IN1</sub> (Note 1)	1608	0.1 μF, B, 50 V	GRM series	Ceramic capacitor	MURATA
C <sub>IN</sub> (Note 2)	3225	10 μF, B, 50 V	GRM series	Ceramic capacitor	MURATA
C <sub>OUT</sub> (Note 3)	3225	22 μF B, 25 V × 2	GRM series	Ceramic capacitor	MURATA
L	7269	3.3μH	CLF7045NIT-3R3N	Inductor	TDK

- (Note 1) In order to reduce the influence of high frequency noise, arrange the 0.1μF ceramic capacitor as close as possible to the V<sub>IN</sub> pin.
- (Note 2) For capacitance of input capacitor, take temperature characteristics, DC bias characteristics, etc. into consideration to set minimum value to no less than 4.7μF.
- (Note 3) In case capacitance value fluctuates due to temperature characteristics, DC bias characteristics, etc. of output capacitor, crossover frequency may fluctuate. When selecting a capacitor, confirm the characteristics of the capacitor in its datasheet. Also, Please use capacitors such as ceramic type are recommended for output capacitor.

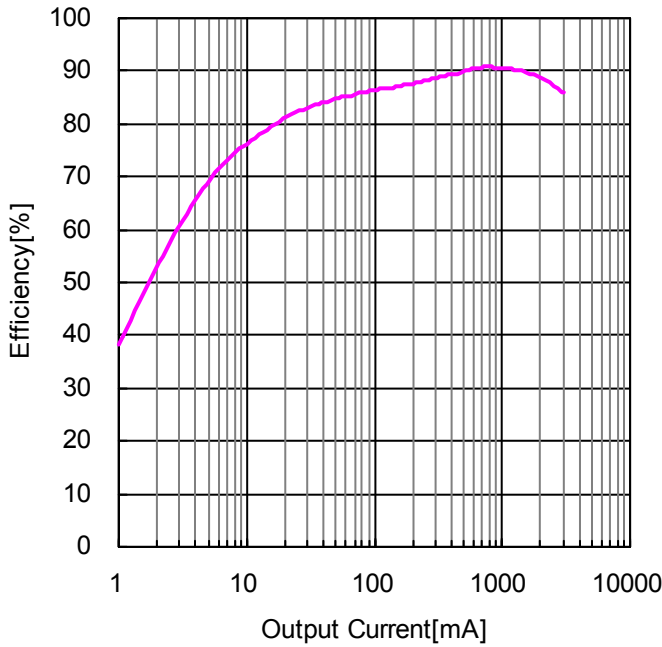

Figure 66. Efficiency - Output Current  
(VIN=12V, VOUT = 3.3V, R3=10kΩ, C1=100pF)

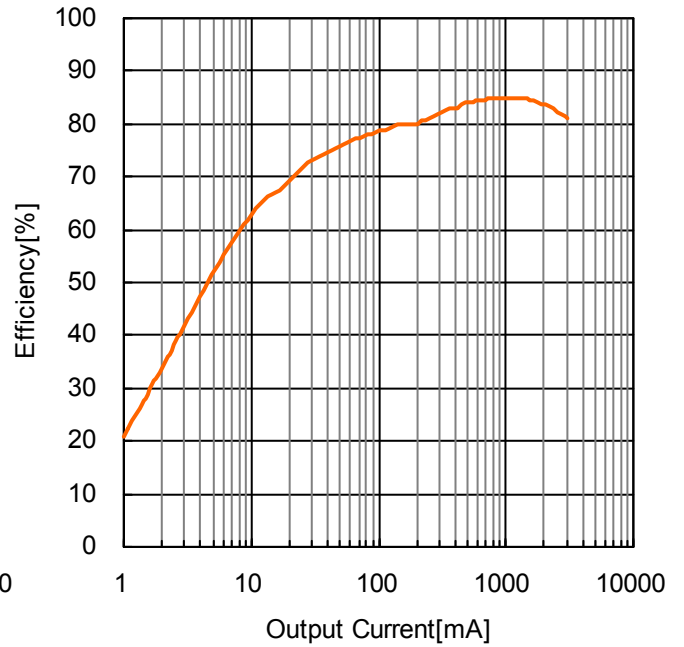

Figure 67. Efficiency - Output Current  
(VIN=24V, VOUT = 3.3V, R3=10kΩ, C1=100pF)

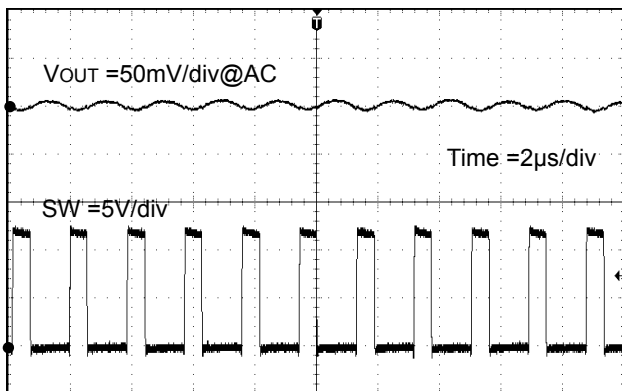

Figure 68. VOUT Ripple  
(VIN = 12V, VOUT = 3.3V, R3=6.8kΩ, C1=100pF)

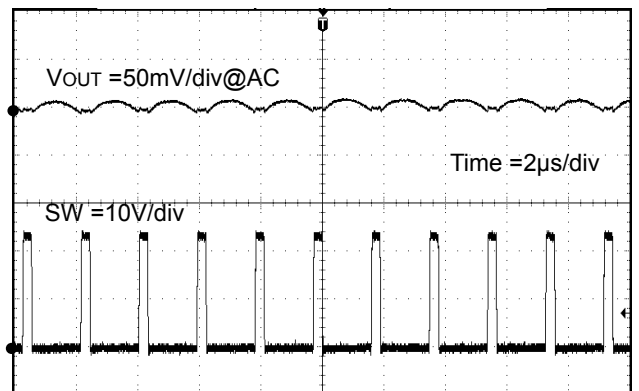

Figure 69. VOUT Ripple  
(VIN = 24V, VOUT = 3.3V, R3=6.8kΩ, C1=100pF)

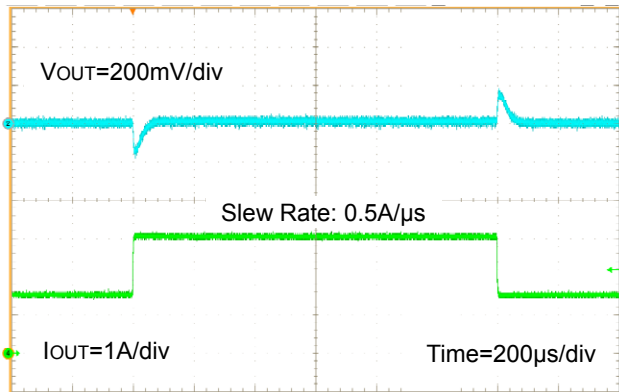

Figure 70. Load Transient Response  $I_{OUT}=1.5A - 3A$   
 ( $V_{IN}=12V$ ,  $V_{OUT}=3.3V$ ,  $R_3=10k\Omega$ ,  $C_1=100pF$ )

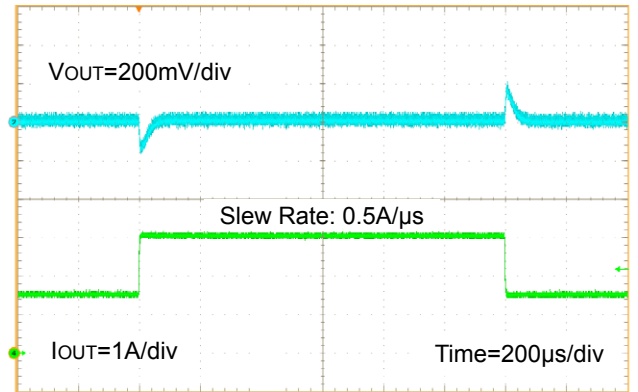

Figure 71. Load Transient Response  $I_{OUT}=1.5A - 3A$   
 ( $V_{IN}=24V$ ,  $V_{OUT}=3.3V$ ,  $R_3=10k\Omega$ ,  $C_1=100pF$ )

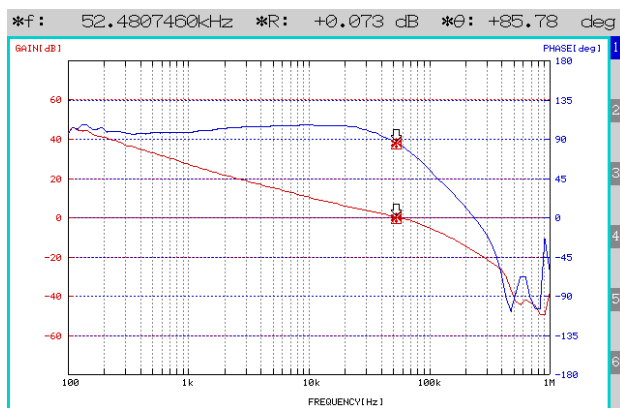

Figure 72. Loop Response  $I_{OUT}=3A$   
 ( $V_{IN}=12V$ ,  $V_{OUT}=3.3V$ ,  $R_3=10k\Omega$ ,  $C_1=100pF$ )

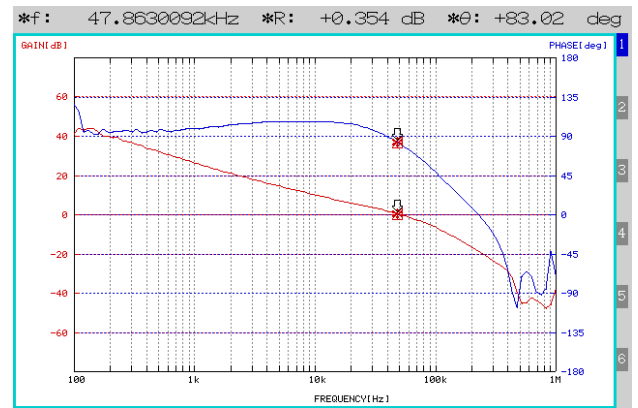

Figure 73. Loop Response  $I_{OUT}=3A$   
 ( $V_{IN}=24V$ ,  $V_{OUT}=3.3V$ ,  $R_3=10k\Omega$ ,  $C_1=100pF$ )

● Selection of Components Externally Connected

About the application except the recommendation, please contact us.

Parameters required to design a power supply are as follows.

Parameter	Symbol	Value Example
Input Voltage	V <sub>IN</sub>	24 V
Output Voltage	V <sub>OUT</sub>	5 V
Switching Frequency	F <sub>OSC</sub>	550kHz(Typ)
Inductor ripple current	ΔI <sub>L</sub>	1.13A
ESR of the output capacitor	R <sub>ESR</sub>	10mΩ
Output capacitor	C <sub>OUT</sub>	44μF(22μF×2)
Soft-start time	T <sub>SS</sub>	2.5ms(Typ)
Max output current	I <sub>OMAX</sub>	3A

1. Switching Frequency

Switching frequency is fixed to F<sub>osc</sub> = 550kHz (Typ).

2. Output Voltage Set Point

The output voltage value can be set by the feedback resistance ratio.

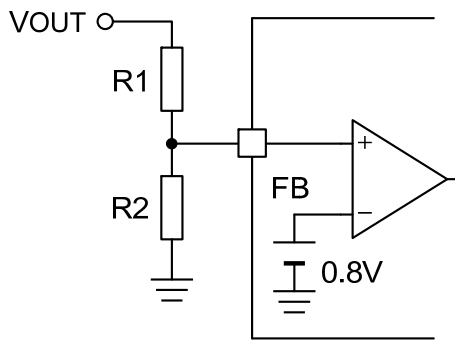

Figure 74. Feedback Resistor Circuit

$$V_{OUT} = \frac{R_1 + R_2}{R_2} \times 0.8 \text{ [V]}$$

※ Minimum pulse range that can be produced at the output stably through all the load area is 200nsec for BD9E302EFJ. Use input/output condition which satisfies the following method.

$$200(\text{nsec}) \leq \frac{V_{OUT}}{V_{IN} \times F_{OSC}}$$

Please set feedback resistor R1 + R2 below 700 kΩ . In addition, since power efficiency is reduced with a small R1 + R2, please set the current flowing through the feedback resistor to be small as possible than the output current I<sub>o</sub>.

3. Input capacitor configuration

For input capacitor, use a ceramic capacitor. It will more effective as close as possible to the V<sub>IN</sub> pin. The rating voltage of input capacitor should be 2 times of V<sub>IN</sub> supply and 1.2 times of maximum V<sub>IN</sub> supply is commanded. For normal setting, 10μF is recommended, but with larger value, input ripple voltage can be further reduced. Also, for capacitance of input capacitor, take temperature characteristics, DC bias characteristics, etc. into consideration, minimum value no less than 4.7μF. In order to reduce the influence of high frequency noise, 0.1μF ceramic capacitor placed as close as possible to the V<sub>IN</sub> pin is commanded.

**4. Output LC Filter**

The DC/DC converter requires an LC filter for smoothing the output voltage in order to supply a continuous current to the load. Selecting an inductor with large inductance causes the ripple current  $\Delta I_L$  that flows into the inductor to be small, decreasing the ripple voltage generated in the output voltage, it is a trade-off of size and cost of the inductor. In BD9E302EFJ, the ripple current feedback to IC, and internal SLLM™(Simple Light Load Mode)control it, Since the optimal operation feedback ripple current designed based on the recommended inductance, please use recommended inductor values.

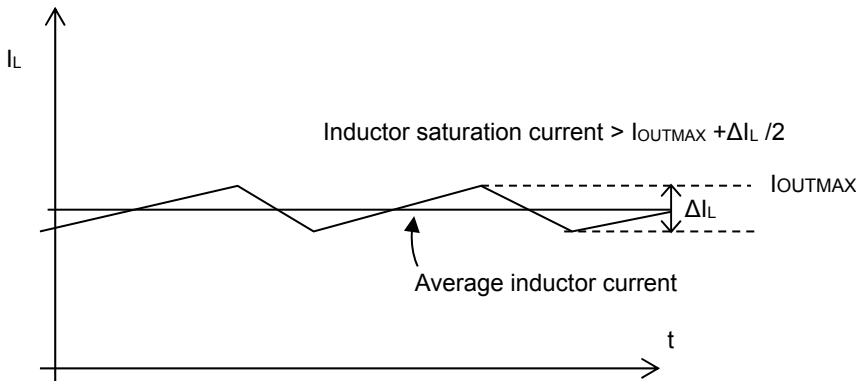

Figure 75. Waveform of current through inductor

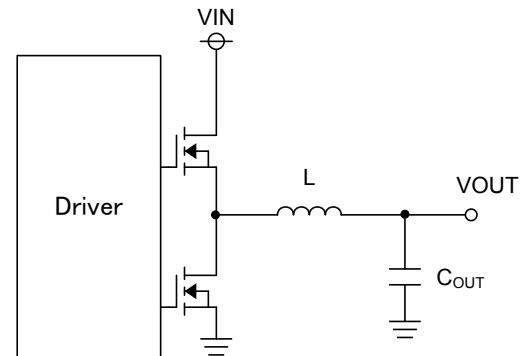

Figure 76. Output LC filter circuit

Here, select an inductance so that the size of the ripple current component of the inductor will be 20% to 50% of the Max output current (3A).

Now calculating with  $V_{IN} = 12V$ ,  $V_{OUT} = 5V$ , switching frequency  $F_{OSC} = 550kHz$ ,  $\Delta I_L$  is 1.0A, inductance value That can be used is calculated as follows:

$$L = V_{OUT} \times (V_{IN} - V_{OUT}) \times \frac{1}{V_{IN} \times F_{OSC} \times \Delta I_L} = 5.3 \approx 4.7 [\mu H]$$

\* If the output voltage setting is larger than half of  $V_{IN}$  please calculated as follows:

$$L = \frac{V_{IN}}{4 \times F_{OSC} \times \Delta I_L}$$

Also for saturation current of inductor, select the one with larger current than maximum output current added by 1/2 of inductor ripple current  $\Delta I_L$ .

Output capacitor  $C_{OUT}$  affects output ripple voltage characteristics. Select output capacitor  $C_{OUT}$  so that necessary ripple voltage characteristics are satisfied.

Output ripple voltage can be expressed in the following method.

$$\Delta V_{RPL} = \Delta I_L \times (R_{ESR} + \frac{1}{8 \times C_{OUT} \times F_{OSC}})$$

$R_{ESR}$  is the equivalent series resistance of the output capacitor

With  $C_{OUT} = 44\mu F$ ,  $R_{ESR} = 10m\Omega$  the output ripple voltage is calculated as

$$\Delta V_{RPL} = 1.0 \times (10m + \frac{1}{8 \times 44\mu \times 550k}) = 15.17 [mV]$$

End the calculation.

\* When selecting the value of the output capacitor C<sub>OUT</sub>, please use ceramic capacitor and please note that the value of capacitor C<sub>LOAD</sub> connected to V<sub>OUT</sub> will be added up to the value of C<sub>OUT</sub>. Charging current to flow through the C<sub>LOAD</sub>, C<sub>OUT</sub> when the IC startup, must be completed this charge within the soft-start time. Over-current protection circuit operates when charging is continued beyond the soft-start time, the IC may not start. The maximum C<sub>LOAD</sub> that can be connected to V<sub>OUT</sub> is calculated by the equation below.

Inductor ripple current maximum value of start-up (I<sub>LSTART</sub>) < Over Current Protection Threshold 4.16 [A](Min)

Inductor ripple current maximum value of start-up (I<sub>LSTART</sub>) can be expressed in the following method.

$$I_{LSTART} = \text{Output maximum load current}(I_{OMAX}) + \text{Charging current to the output capacitor} (I_{CAP}) + \frac{\Delta I_L}{2}$$

Charging current to the output capacitor (I<sub>CAP</sub>) can be expressed in the following method.

$$I_{CAP} = \frac{(C_{OUT} + C_{LOAD}) \times V_{OUT}}{T_{SS}}$$

From the above equation, V<sub>IN</sub> = 12V, V<sub>OUT</sub> = 5V, L = 4.7μH, I<sub>OMAX</sub> = 3.0A (Max), switching frequency F<sub>OSC</sub> = 484kHz (Min), ΔI<sub>L</sub>=1.282A (Max), the output capacitor C<sub>OUT</sub> = 44μF, T<sub>SS</sub> = 1.2ms soft-start time (Min), it becomes the following equation when calculating the maximum output load capacitance C<sub>LOAD</sub> (Max) that can be connected to V<sub>OUT</sub>.

$$C_{LOAD} (Max) < \frac{(4.16 - I_{OMAX} - \Delta I_L / 2) \times T_{SS}}{V_{OUT}} - C_{OUT} = 80.56 [\mu F]$$

### 5. Input voltage start-up

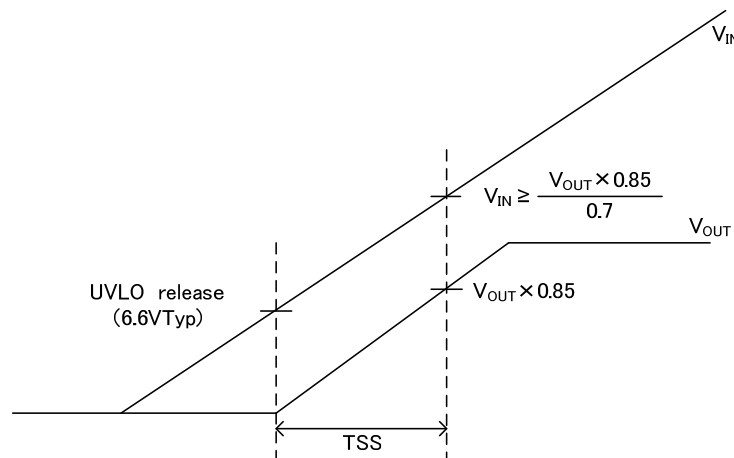

Figure 77. Input Voltage Start-up Time

Soft-start function is designed for the IC so that the output voltage will start according to the time that was decided internally. After UVLO release, the output voltage range will be less than 70% of the input voltage at soft-start operation. Please be sure that the input voltage of the soft-start after startup is as follows.

$$V_{IN} \geq \frac{V_{OUT} \times 0.85}{0.7} [V]$$



## 6. Phase Compensation

A current mode control buck DC/DC converter is a one-pole, one-zero system. The poles are formed by an error amplifier and the one load and the one zero point is added by the phase compensation. The phase compensation resistor  $R_3$  determines the crossover frequency  $F_{CRS}$  (20kHz (Typ)) where the total loop gain of the DC/DC converter is 0 dB. The high value of this crossover frequency  $F_{CRS}$  provides a good load transient response characteristic but inferior stability. Conversely, specifying a low value for the crossover frequency  $F_{CRS}$  greatly stabilizes the characteristics but the load transient response characteristic is impaired.

### (1) Selection of Phase Compensation Resistor $R_3$

The phase compensation resistance  $R_3$  can be determined by using the following equation.

$$R_3 = \frac{2\pi \times V_{OUT} \times F_{CRS} \times C_{OUT}}{V_{FB} \times G_{MP} \times G_{MA}} [\Omega]$$

where :

$V_{OUT}$  is the output voltage

$F_{CRS}$  is the crossover frequency

$C_{OUT}$  is the output capacitance

$V_{FB}$  is the feedback reference voltage (0.8 V (Typ))

$G_{MP}$  is the current sense gain (20A/V (Typ))

$G_{MA}$  is the error amplifier transconductance (140  $\mu$ A/V (Typ))

\* The actual  $F_{CRS}$  may different from the value in equation due to DC bias characteristics of  $C_{OUT}$ .  
Please set  $R_3$  base on the actual evaluation.

### (2) Selection of phase compensation capacitance $C_2$

For stable operation of the DC/DC converter, inserting a zero point under 1/6 of the zero crossover frequency cancels the phase delay due to the pole formed by the load often, thus, providing favorable characteristics. Please use capacitors for  $C_2$  such as ceramic type.

The phase compensation capacitance  $C_2$  can be determined by using the following equation.

$$C_2 = \frac{1}{2\pi \times R_3 \times F_Z} [F]$$

where

$F_Z$  is the Zero point inserted

\* In case  $C_2$  calculated result exceeds 0.015 $\mu$ F, set the value of compensation capacitance  $C_2$  0.015 $\mu$ F. Setting too large  $C_2$  value maybe cause startup failure etc.

### (3) Selection of Phase Compensation Capacitance $C_1$

Adding zero point at 20 kHz is recommended to get a better transient load response characteristic for DC/DC converter. Please use capacitors for  $C_1$  such as ceramic type, and set value below 1000pF.

$C_1$  can be determined by the following equation.

$$C_1 = \frac{1}{2\pi \times R_1 \times 20kHz} [F]$$

### (4) Loop stability

In order to ensure stability of DC/DC converter, confirm there is enough phase margin on actual equipment.

Under the worst condition, it is recommended to ensure phase margin is 45° or more. In fact, the characteristics may variable due to PCB layout, routing of wiring, types of used components and operating environments (temperature etc.). Use gain-phase analyzer or FRA to confirm frequency characteristics on actual equipment. Contact the manufacturer of each measuring equipment to check its measuring method, etc.

## 7. Bootstrap capacitor

Bootstrap capacitor  $C_{BOOT}$  shall be 0.1 $\mu$ F. Connect a bootstrap capacitor between SW pin and BOOT pin.

For capacitance of Bootstrap capacitor, take temperature characteristics, DC bias characteristics, etc. into consideration.

● PCB Layout Design

In the buck DC/DC converter, a large pulsed current flows in two loops. The first loop is the one into which the current flows when the High Side FET is turned on. The flow starts from the input capacitor  $C_{IN}$ , runs through the FET, inductor L and output capacitor  $C_{OUT}$  and back to ground of  $C_{IN}$  via ground of  $C_{OUT}$ . The second loop is the one into which the current flows when the Low Side FET is turned on. The flow starts from the Low Side FET, runs through the inductor L and output capacitor  $C_{OUT}$  and back to ground of the Low Side FET via ground of  $C_{OUT}$ . Tracing these two loops as thick and short as possible allows noise to be reduced for improved efficiency. It is recommended to connect the input and output capacitors, in particular, to the ground plane. The PCB layout has a great influence on the DC/DC converter in terms of all of the heat generation, noise and efficiency characteristics.

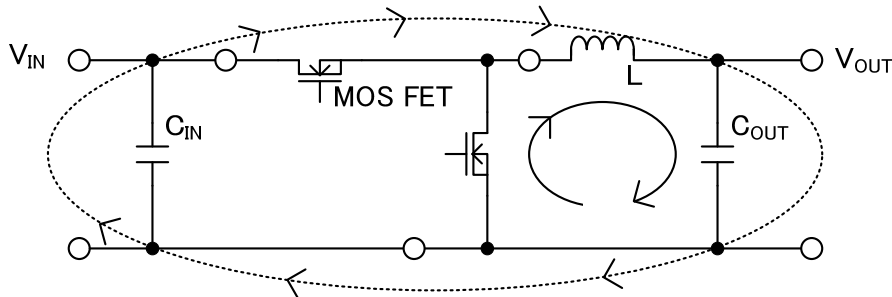
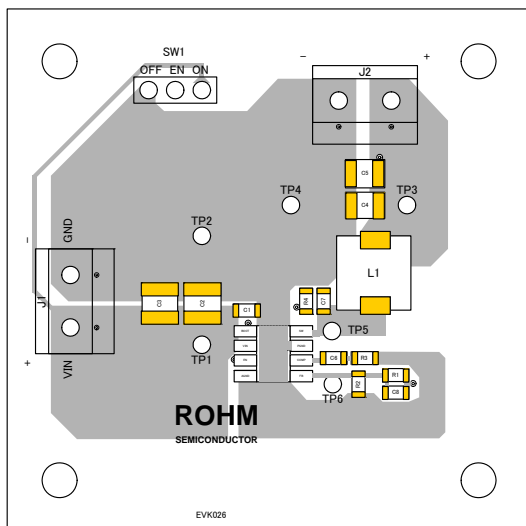

Figure 78. Current loop of buck converter

Accordingly, design the PCB layout with particular attention paid to the following points.

- Provide the input capacitor close to the IC VIN terminal as possible on the same plane as the IC.
- If there is any unused area on the PCB, provide a copper foil plane for the ground node to assist heat dissipation from the IC and the surrounding components.
- Switching nodes such as SW are susceptible to noise due to AC coupling with other nodes. Trace to the coil as thick and as short as possible.
- Provide lines connected to FB and COMP as far from the SW node.
- COMP terminal is sensitive to high frequency harmonic noise, it is recommended that the external components of this terminal placed close to the pin.
- Provide the output capacitor away from the input capacitor in order to avoid the effect of harmonic noise from the input.



Top Layer

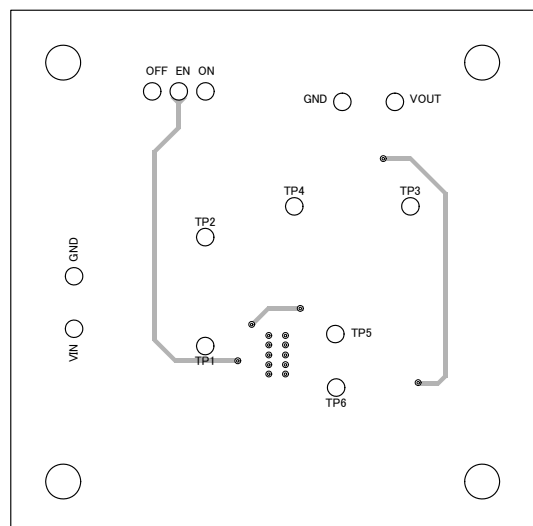

Bottom Layer

Figure 79. Example of sample board layout pattern

● I/O Equivalence Circuit

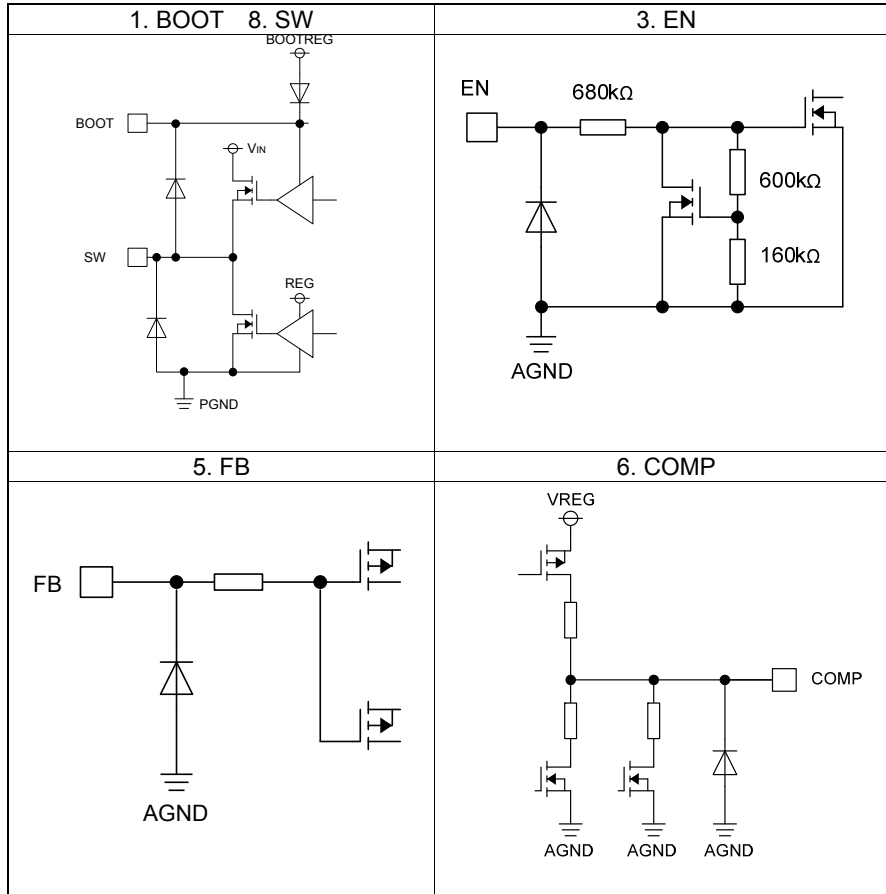

Figure 80. I/O equivalence circuit

**●Operational Notes****1. Reverse Connection of Power Supply**

Connecting the power supply in reverse polarity can damage the IC. Take precautions against reverse polarity when connecting the power supply, such as mounting an external diode between the power supply and the IC's power supply pins.

**2. Power Supply Lines**

Design the PCB layout pattern to provide low impedance supply lines. Separate the ground and supply lines of the digital and analog blocks to prevent noise in the ground and supply lines of the digital block from affecting the analog block. Furthermore, connect a capacitor to ground at all power supply pins. Consider the effect of temperature and aging on the capacitance value when using electrolytic capacitors.

**3. Ground Voltage**

Ensure that no pins are at a voltage below that of the ground pin at any time, even during transient condition. However, pins that drive inductive loads (e.g. motor driver outputs, DC-DC converter outputs) may inevitably go below ground due to back EMF or electromotive force. In such cases, the user should make sure that such voltages going below ground will not cause the IC and the system to malfunction by examining carefully all relevant factors and conditions such as motor characteristics, supply voltage, operating frequency and PCB wiring to name a few.

**4. Ground Wiring Pattern**

When using both small-signal and large-current ground traces, the two ground traces should be routed separately but connected to a single ground at the reference point of the application board to avoid fluctuations in the small-signal ground caused by large currents. Also ensure that the ground traces of external components do not cause variations on the ground voltage. The ground lines must be as short and thick as possible to reduce line impedance.

**5. Thermal Consideration**

Should by any chance the maximum junction temperature rating be exceeded the rise in temperature of the chip may result in deterioration of the properties of the chip. In case of exceeding this absolute maximum rating, increase the board size and copper area to prevent exceeding the maximum junction temperature rating.

**6. Recommended Operating Conditions**

These conditions represent a range within which the expected characteristics of the IC can be approximately obtained. The electrical characteristics are guaranteed under the conditions of each parameter.

**7. Inrush Current**

When power is first supplied to the IC, it is possible that the internal logic may be unstable and inrush current may flow instantaneously due to the internal powering sequence and delays, especially if the IC has more than one power supply. Therefore, give special consideration to power coupling capacitance, power wiring, width of ground wiring, and routing of connections.

**8. Operation Under Strong Electromagnetic Field**

Operating the IC in the presence of a strong electromagnetic field may cause the IC to malfunction.

Operational Notes – continued

9. Testing on Application Boards

When testing the IC on an application board, connecting a capacitor directly to a low-impedance output pin may subject the IC to stress. Always discharge capacitors completely after each process or step. The IC’s power supply should always be turned off completely before connecting or removing it from the test setup during the inspection process. To prevent damage from static discharge, ground the IC during assembly and use similar precautions during transport and storage.

10. Inter-pin Short and Mounting Errors

Ensure that the direction and position are correct when mounting the IC on the PCB. Incorrect mounting may result in damaging the IC. Avoid nearby pins being shorted to each other especially to ground, power supply and output pin. Inter-pin shorts could be due to many reasons such as metal particles, water droplets (in very humid environment) and unintentional solder bridge deposited in between pins during assembly to name a few.

11. Unused Input Pins

Input pins of an IC are often connected to the gate of a MOS transistor. The gate has extremely high impedance and extremely low capacitance. If left unconnected, the electric field from the outside can easily charge it. The small charge acquired in this way is enough to produce a significant effect on the conduction through the transistor and cause unexpected operation of the IC. So unless otherwise specified, unused input pins should be connected to the power supply or ground line.

12. Regarding the Input Pin of the IC

This monolithic IC contains P+ isolation and P substrate layers between adjacent elements in order to keep them isolated. P-N junctions are formed at the intersection of the P layers with the N layers of other elements, creating a parasitic diode or transistor. For example (refer to figure below):

When GND > Pin A and GND > Pin B, the P-N junction operates as a parasitic diode.  
 When GND > Pin B, the P-N junction operates as a parasitic transistor.

Parasitic diodes inevitably occur in the structure of the IC. The operation of parasitic diodes can result in mutual interference among circuits, operational faults, or physical damage. Therefore, conditions that cause these diodes to operate, such as applying a voltage lower than the GND voltage to an input pin (and thus to the P substrate) should be avoided.

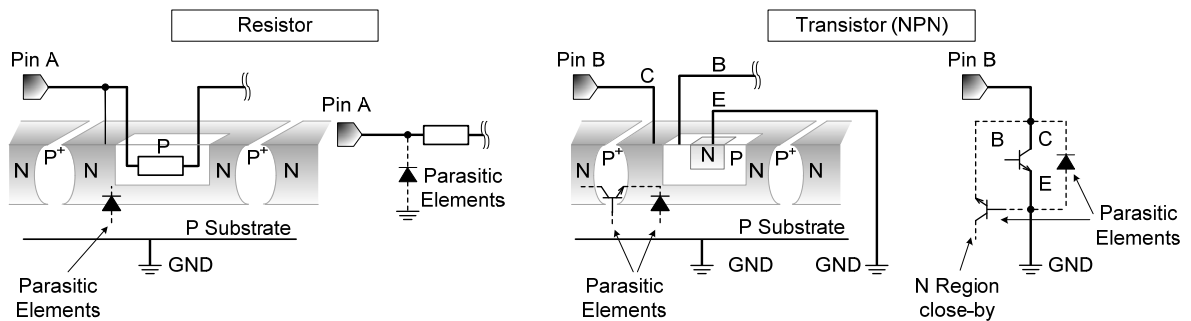

Figure 81. Example of monolithic IC structure

13. Ceramic Capacitor

When using a ceramic capacitor, determine the dielectric constant considering the change of capacitance with temperature and the decrease in nominal capacitance due to DC bias and others.

14. Area of Safe Operation (ASO)

Operate the IC such that the output voltage, output current, and the maximum junction temperature rating are all within the Area of Safe Operation (ASO).

**Operational Notes – continued****15. Thermal Shutdown Circuit(TSD)**

This IC has a built-in thermal shutdown circuit that prevents heat damage to the IC. Normal operation should always be within the IC's maximum junction temperature rating. If however the rating is exceeded for a continued period, the junction temperature ( $T_j$ ) will rise which will activate the TSD circuit that will turn OFF all output pins. When the  $T_j$  falls below the TSD threshold, the circuits are automatically restored to normal operation.

Note that the TSD circuit operates in a situation that exceeds the absolute maximum ratings and therefore, under no circumstances, should the TSD circuit be used in a set design or for any purpose other than protecting the IC from heat damage.

**16. Over Current Protection Circuit (OCP)**

This IC incorporates an integrated overcurrent protection circuit that is activated when the load is shorted. This protection circuit is effective in preventing damage due to sudden and unexpected incidents. However, the IC should not be used in applications characterized by continuous operation or transitioning of the protection circuit.

●Ordering Information

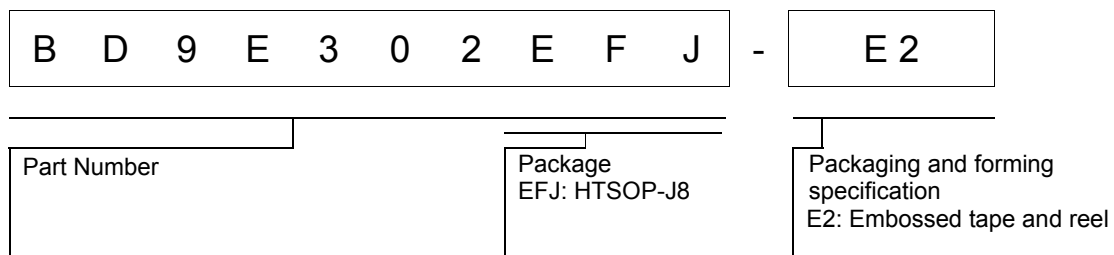

●Marking Diagram

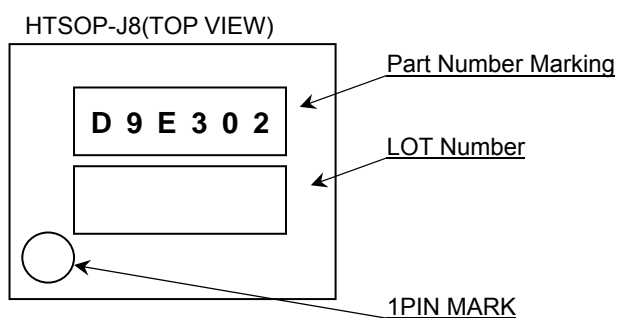

●Physical Dimension, Tape and Reel Information – continued

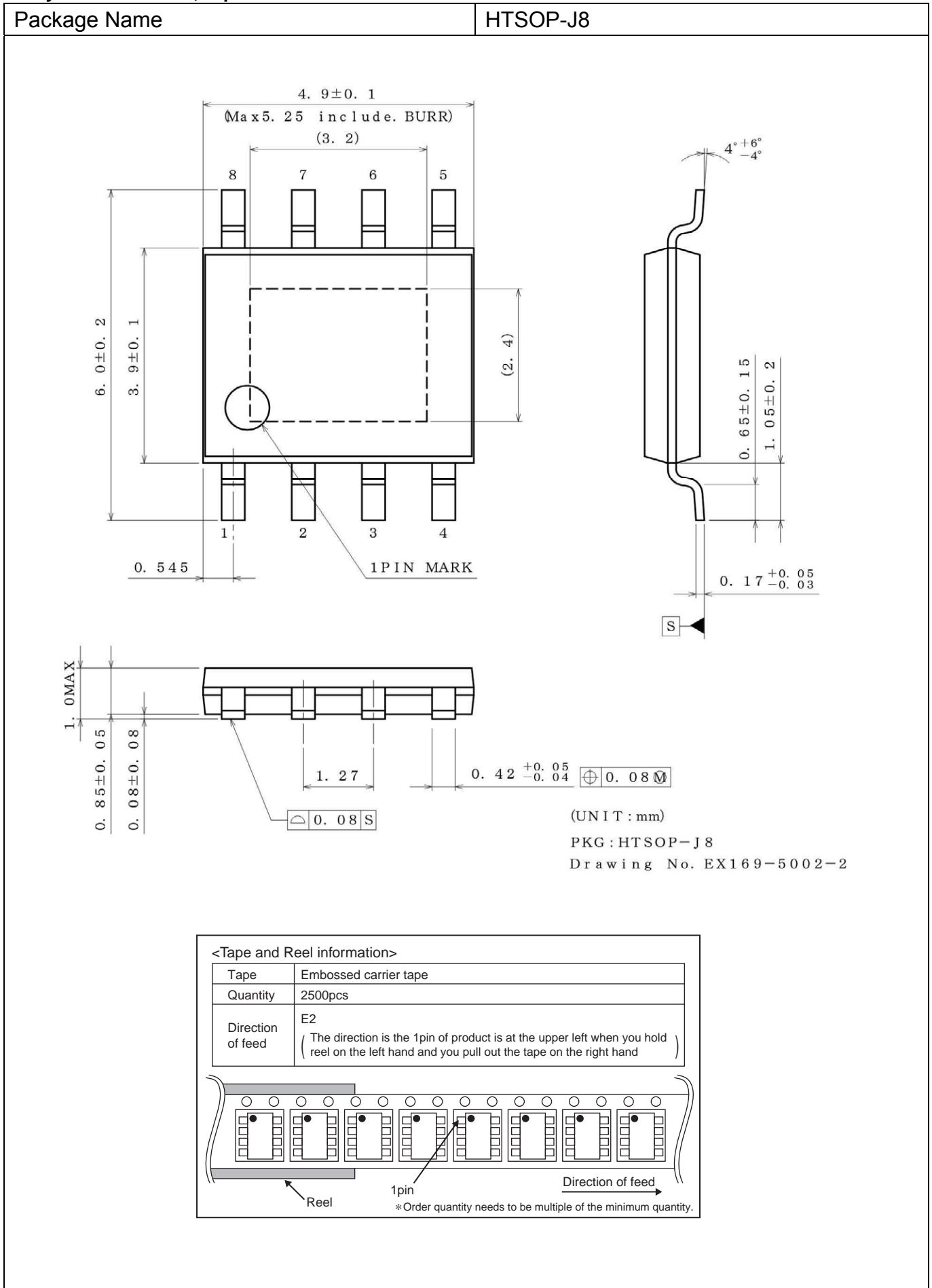



## ●Revision History

Date	Revision	Description
22. Jan. '16	001	New
27.Apr.2016	002	Page.5 Thermal Resistance - Footprints and Traces 74.2mm <sup>2</sup> (Square) ⇒ 74.2mm x 74.2mm

# Notice

## Precaution on using ROHM Products

- Our Products are designed and manufactured for application in ordinary electronic equipments (such as AV equipment, OA equipment, telecommunication equipment, home electronic appliances, amusement equipment, etc.). If you intend to use our Products in devices requiring extremely high reliability (such as medical equipment <sup>(Note 1)</sup>, transport equipment, traffic equipment, aircraft/spacecraft, nuclear power controllers, fuel controllers, car equipment including car accessories, safety devices, etc.) and whose malfunction or failure may cause loss of human life, bodily injury or serious damage to property ("Specific Applications"), please consult with the ROHM sales representative in advance. Unless otherwise agreed in writing by ROHM in advance, ROHM shall not be in any way responsible or liable for any damages, expenses or losses incurred by you or third parties arising from the use of any ROHM's Products for Specific Applications.

(Note1) Medical Equipment Classification of the Specific Applications

JAPAN	USA	EU	CHINA
CLASS III	CLASS III	CLASS II b	CLASS III
CLASS IV		CLASS III	

- ROHM designs and manufactures its Products subject to strict quality control system. However, semiconductor products can fail or malfunction at a certain rate. Please be sure to implement, at your own responsibilities, adequate safety measures including but not limited to fail-safe design against the physical injury, damage to any property, which a failure or malfunction of our Products may cause. The following are examples of safety measures:
  - Installation of protection circuits or other protective devices to improve system safety
  - Installation of redundant circuits to reduce the impact of single or multiple circuit failure
- Our Products are designed and manufactured for use under standard conditions and not under any special or extraordinary environments or conditions, as exemplified below. Accordingly, ROHM shall not be in any way responsible or liable for any damages, expenses or losses arising from the use of any ROHM's Products under any special or extraordinary environments or conditions. If you intend to use our Products under any special or extraordinary environments or conditions (as exemplified below), your independent verification and confirmation of product performance, reliability, etc. prior to use, must be necessary:
  - Use of our Products in any types of liquid, including water, oils, chemicals, and organic solvents
  - Use of our Products outdoors or in places where the Products are exposed to direct sunlight or dust
  - Use of our Products in places where the Products are exposed to sea wind or corrosive gases, including Cl<sub>2</sub>, H<sub>2</sub>S, NH<sub>3</sub>, SO<sub>2</sub>, and NO<sub>2</sub>
  - Use of our Products in places where the Products are exposed to static electricity or electromagnetic waves
  - Use of our Products in proximity to heat-producing components, plastic cords, or other flammable items
  - Sealing or coating our Products with resin or other coating materials
  - Use of our Products without cleaning residue of flux (even if you use no-clean type fluxes, cleaning residue of flux is recommended); or Washing our Products by using water or water-soluble cleaning agents for cleaning residue after soldering
  - Use of the Products in places subject to dew condensation
- The Products are not subject to radiation-proof design.
- Please verify and confirm characteristics of the final or mounted products in using the Products.
- In particular, if a transient load (a large amount of load applied in a short period of time, such as pulse. is applied, confirmation of performance characteristics after on-board mounting is strongly recommended. Avoid applying power exceeding normal rated power; exceeding the power rating under steady-state loading condition may negatively affect product performance and reliability.
- De-rate Power Dissipation depending on ambient temperature. When used in sealed area, confirm that it is the use in the range that does not exceed the maximum junction temperature.
- Confirm that operation temperature is within the specified range described in the product specification.
- ROHM shall not be in any way responsible or liable for failure induced under deviant condition from what is defined in this document.

## Precaution for Mounting / Circuit board design

- When a highly active halogenous (chlorine, bromine, etc.) flux is used, the residue of flux may negatively affect product performance and reliability.
- In principle, the reflow soldering method must be used on a surface-mount products, the flow soldering method must be used on a through hole mount products. If the flow soldering method is preferred on a surface-mount products, please consult with the ROHM representative in advance.

For details, please refer to ROHM Mounting specification

### Precautions Regarding Application Examples and External Circuits

1. If change is made to the constant of an external circuit, please allow a sufficient margin considering variations of the characteristics of the Products and external components, including transient characteristics, as well as static characteristics.
2. You agree that application notes, reference designs, and associated data and information contained in this document are presented only as guidance for Products use. Therefore, in case you use such information, you are solely responsible for it and you must exercise your own independent verification and judgment in the use of such information contained in this document. ROHM shall not be in any way responsible or liable for any damages, expenses or losses incurred by you or third parties arising from the use of such information.

### Precaution for Electrostatic

This Product is electrostatic sensitive product, which may be damaged due to electrostatic discharge. Please take proper caution in your manufacturing process and storage so that voltage exceeding the Products maximum rating will not be applied to Products. Please take special care under dry condition (e.g. Grounding of human body / equipment / solder iron, isolation from charged objects, setting of Ionizer, friction prevention and temperature / humidity control).

### Precaution for Storage / Transportation

1. Product performance and soldered connections may deteriorate if the Products are stored in the places where:
  - [a] the Products are exposed to sea winds or corrosive gases, including Cl<sub>2</sub>, H<sub>2</sub>S, NH<sub>3</sub>, SO<sub>2</sub>, and NO<sub>2</sub>
  - [b] the temperature or humidity exceeds those recommended by ROHM
  - [c] the Products are exposed to direct sunshine or condensation
  - [d] the Products are exposed to high Electrostatic
2. Even under ROHM recommended storage condition, solderability of products out of recommended storage time period may be degraded. It is strongly recommended to confirm solderability before using Products of which storage time is exceeding the recommended storage time period.
3. Store / transport cartons in the correct direction, which is indicated on a carton with a symbol. Otherwise bent leads may occur due to excessive stress applied when dropping of a carton.
4. Use Products within the specified time after opening a humidity barrier bag. Baking is required before using Products of which storage time is exceeding the recommended storage time period.

### Precaution for Product Label

A two-dimensional barcode printed on ROHM Products label is for ROHM's internal use only.

### Precaution for Disposition

When disposing Products please dispose them properly using an authorized industry waste company.

### Precaution for Foreign Exchange and Foreign Trade act

Since concerned goods might be fallen under listed items of export control prescribed by Foreign exchange and Foreign trade act, please consult with ROHM in case of export.

### Precaution Regarding Intellectual Property Rights

1. All information and data including but not limited to application example contained in this document is for reference only. ROHM does not warrant that foregoing information or data will not infringe any intellectual property rights or any other rights of any third party regarding such information or data.
2. ROHM shall not have any obligations where the claims, actions or demands arising from the combination of the Products with other articles such as components, circuits, systems or external equipment (including software).
3. No license, expressly or implied, is granted hereby under any intellectual property rights or other rights of ROHM or any third parties with respect to the Products or the information contained in this document. Provided, however, that ROHM will not assert its intellectual property rights or other rights against you or your customers to the extent necessary to manufacture or sell products containing the Products, subject to the terms and conditions herein.

### Other Precaution

1. This document may not be reprinted or reproduced, in whole or in part, without prior written consent of ROHM.
2. The Products may not be disassembled, converted, modified, reproduced or otherwise changed without prior written consent of ROHM.
3. In no event shall you use in any way whatsoever the Products and the related technical information contained in the Products or this document for any military purposes, including but not limited to, the development of mass-destruction weapons.
4. The proper names of companies or products described in this document are trademarks or registered trademarks of ROHM, its affiliated companies or third parties.