

1

2

3

4

5

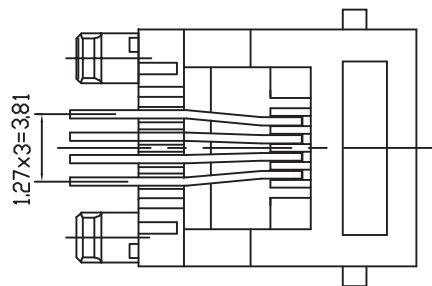

1.27x3=3.81

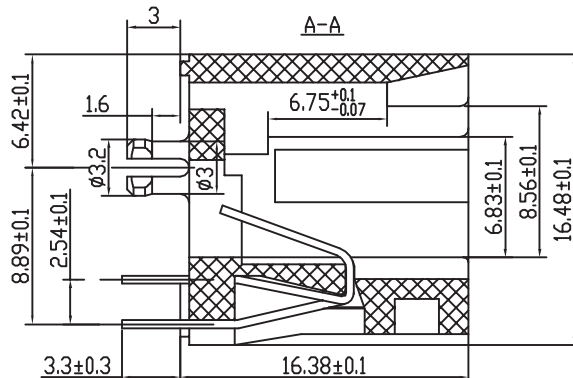
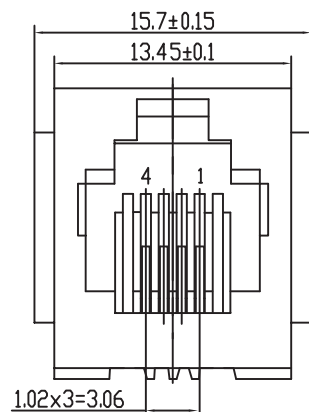

IA

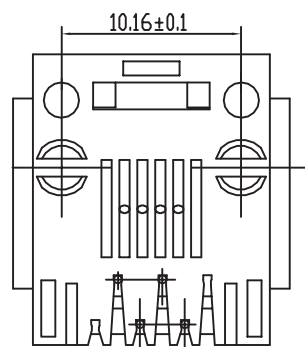

IA

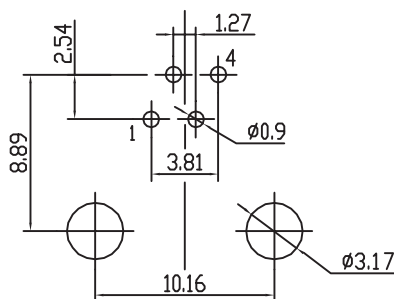

PCB LAYOUT - COMPONENT VIEW

TECHNICAL CHARACTERISTICS

MATERIAL
 INSULATOR MATERIAL: PBT
 FLAMMABILITY RATING: UL94-V0
 COLOR: BLACK
 CONTACT MATERIAL: COPPER ALLOY
 CONTACT TYPE: STAMPED
 CONTACT PLATING: GOLD
 QUALITY CLASS: 500 MATING CYCLES

ENVIRONMENTAL
 OPERATING TEMPERATURE: -25 °C UP TO 85 °C
 COMPLIANCE: LEAD FREE AND ROHS

ELECTRICAL
 CURRENT RATING: 1.5 A
 WORKING VOLTAGE: 120 VAC
 INSULATION RESISTANCE: >500 MΩ
 DIELECTRIC WITHSTANDING VOLTAGE: 1 000 VAC/MIN
 CONTACT RESISTANCE: 20 mΩ MAX

STANDARD
 CERTIFIED: E324776

SOLDERING
 JEDEC LEAD FREE WAVE SOLDERING PROCESS

PACKAGING
 TRAY

RoHS Compliant

G	28-JUL-14	GENERAL UPDATE	AS
F	01-JAN-14	TPK DWG ADD	QL
E	19-AUG-13	DIM UPDATE	QL
D	19-JAN-10	DRAW PINS	JP
C	07-OCT-09	DRAW & UL STD	JP
B	07-OCT-09	NO SHIELD. MAT.	JP
A	05-NOV-08	PDF	CH
REV	DATE	FILE	BY

PROJECTION:



APPROVAL: RJ

GENERAL TOLERANCE

.X = +/- 0.2

.XX = +/- 0.15



DESCRIPTION: VERTICAL PLASTIC 6P4C MODULAR JACK WITH EARS

WERI PART NO: 615 004 144 121

SIZE

A4

1

2

3

4

5

A

B

C

D

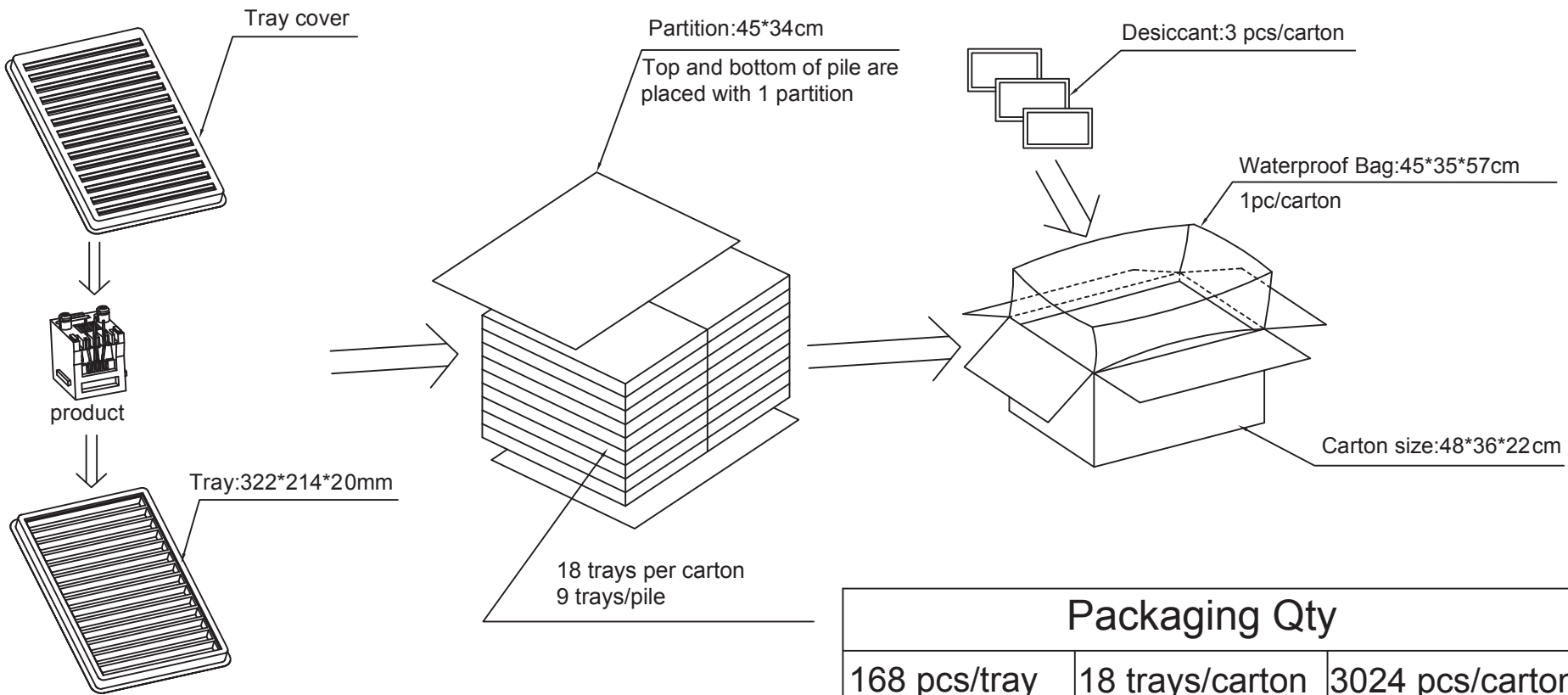

Packaging Qty		
168 pcs/tray	18 trays/carton	3024 pcs/carton

RoHS Compliant			
G			
F			
E			
D			
C			
B			
A			
REV	DATE	FILE	BY

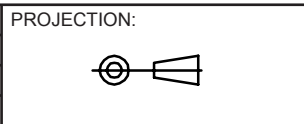

GENERAL TOLERANCE

.X = +/- 0.2

.XX = +/- 0.15



APPROVAL: RJ

UNIT: MM

SCALE:

SHEET: 1/1

DRAW:

DESCRIPTION: VERTICAL PLASTIC 6P4C MODULAR JACK WITH EARS

WERI PART NO: 615 004 144 121

SIZE

A4