



# UPC2709T, UPC2712T

## 2.5 GHz SILICON MMIC WIDE-BAND AMPLIFIER

### FEATURES

- **WIDE FREQUENCY RESPONSE:** 2.5 GHz
- **HIGH GAIN:** 23 dB (UPC2709T)
- **SATURATED OUTPUT POWER:** +11.5 dBm (UPC2709T)
- **INTERNAL CURRENT REGULATION MINIMIZES GAIN CHANGE OVER TEMPERATURE**
- **5 V SINGLE SUPPLY VOLTAGE**
- **SUPER SMALL PACKAGE**
- **TAPE AND REEL PACKAGING OPTION AVAILABLE**

### DESCRIPTION

NEC's UPC2709T and UPC2712T are Silicon Monolithic integrated circuits manufactured using the NESAT III process. These devices are suitable as buffer amplifiers for wide-band applications. They are designed for low cost gain stages in cellular radios, GPS receivers, DBS tuners, PCN, and test/measurement equipment.

NEC's stringent quality assurance and test procedures ensure the highest reliability and performance.

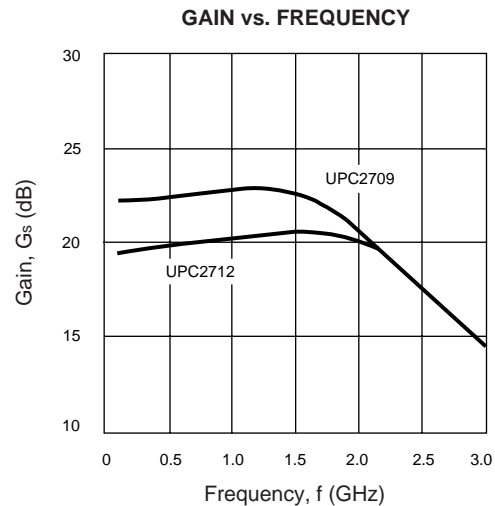

### ELECTRICAL CHARACTERISTICS (T<sub>A</sub> = 25°C, f = 1 GHz, V<sub>CC</sub> = 5 V)

PART NUMBER PACKAGE OUTLINE			UPC2709T T06			UPC2712T T06		
SYMBOLS	PARAMETERS AND CONDITIONS	UNITS	MIN	TYP	MAX	MIN	TYP	MAX
I <sub>CC</sub>	Circuit Current (no signal)	mA	19	25	32	9	12	15
G <sub>s</sub>	Small Signal Gain	dB	21	23	26.5	18	20	23.5
f <sub>U</sub>	Upper Limit Operating Frequency (The gain at f <sub>U</sub> is 3 dB down from the gain at 0.1 GHz)	GHz	2.0	2.3		2.2	2.6	
ΔG <sub>s</sub>	Gain Flatness, f = 0.1 ~ 1.8 GHz f = 0.1 ~ 2.0 GHz	dB		±1.0			±0.8	
P <sub>SAT</sub>	Saturated Output Power	dBm	9	11.5		0	3	
P <sub>1dB</sub>	Output Power at 1 dB Compression Point	dBm		7.5			-2.5	
NF	Noise Figure	dB		5	6.5		4.5	6
R <sub>LIN</sub>	Input Return Loss	dB	7	10		9	12	
R <sub>LOUT</sub>	Output Return Loss	dB	7	10		10	13	
ISOL	Isolation	dB	26	31		28	33	
ΔG <sub>T</sub>	Gain -Temperature Coefficient	dB/°C		-0.002			-0.003	
R <sub>TH</sub>	Thermal Resistance (Junction to Ambient)	°C/W			200			200

The information in this document is subject to change without notice. Before using this document, please confirm that this is the latest version.

**ABSOLUTE MAXIMUM RATINGS<sup>1</sup>** (T<sub>A</sub> = 25°C)

SYMBOLS	PARAMETERS	UNITS	RATINGS
V <sub>CC</sub>	Supply Voltage	V	6
I <sub>CC</sub>	Total Circuit Current UPC2709T UPC2712T	mA mA	60 30
P <sub>IN</sub>	Input Power	dBm	+10
P <sub>T</sub>	Power Dissipation <sup>2</sup>	mW	280
T <sub>OP</sub>	Operating Temperature	°C	-40 to +85
T <sub>STG</sub>	Storage Temperature	°C	-55 to +150

Notes:

1. Operation in excess of any one of these parameters may result in permanent damage.
2. Mounted on 50 x 50 x 1.6 mm epoxy glass PWB (T<sub>A</sub> = +85°C).

**RECOMMENDED OPERATING CONDITIONS**

SYMBOL	PARAMETER	UNITS	MIN	TYP	MAX
V <sub>CC</sub>	Supply Voltage	V	4.5	5.0	5.5

**TEST CIRCUIT**

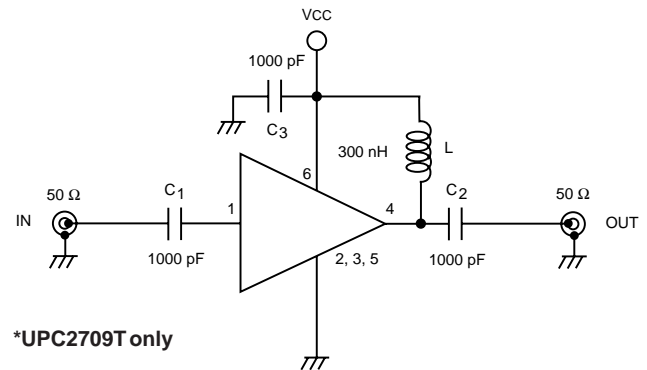

**TYPICAL PERFORMANCE CURVES** (T<sub>A</sub> = 25°C)

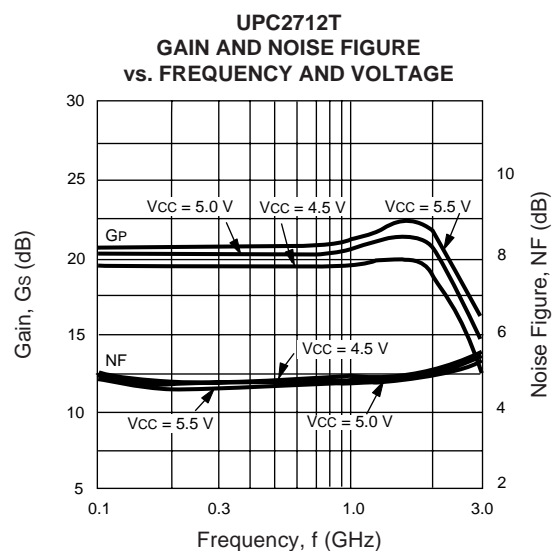
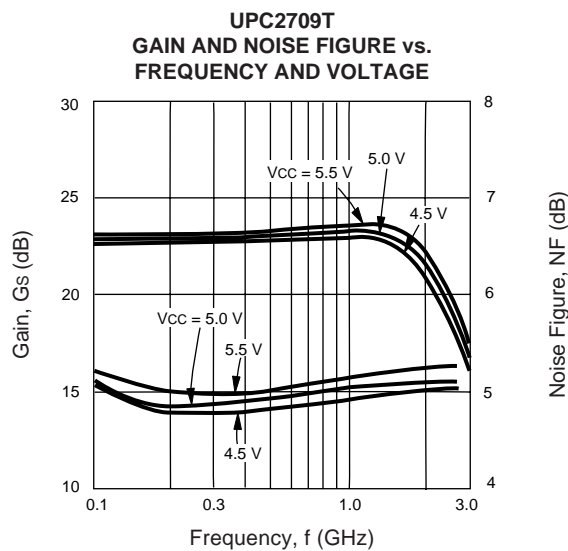
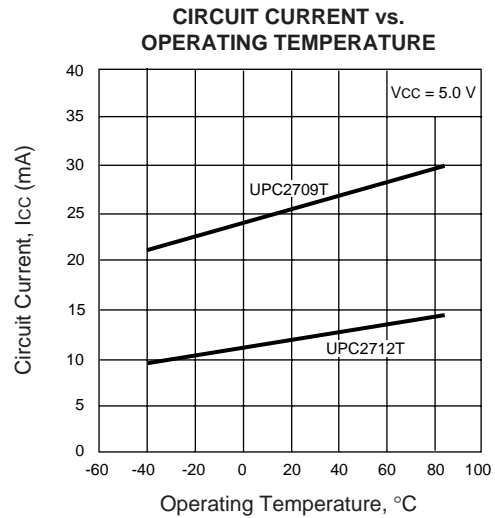
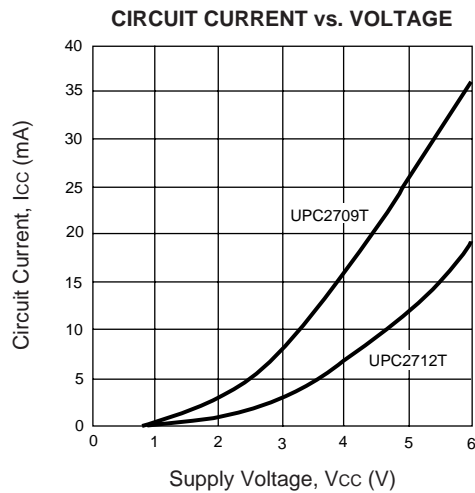

**TYPICAL PERFORMANCE CURVES** ( $T_A = 25^\circ\text{C}$ )

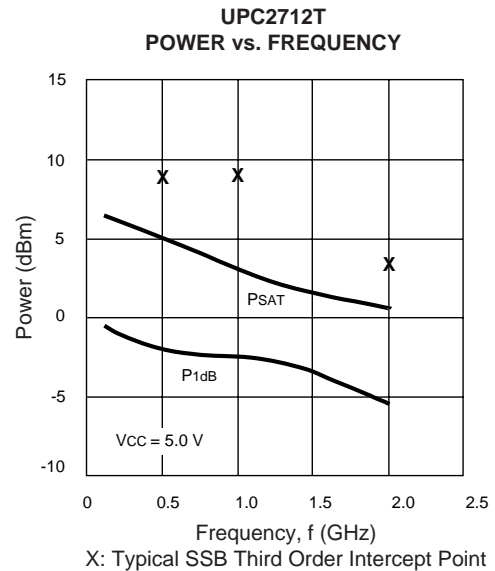
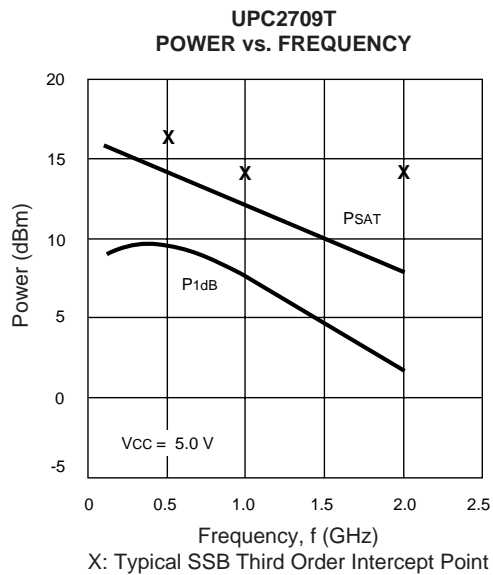
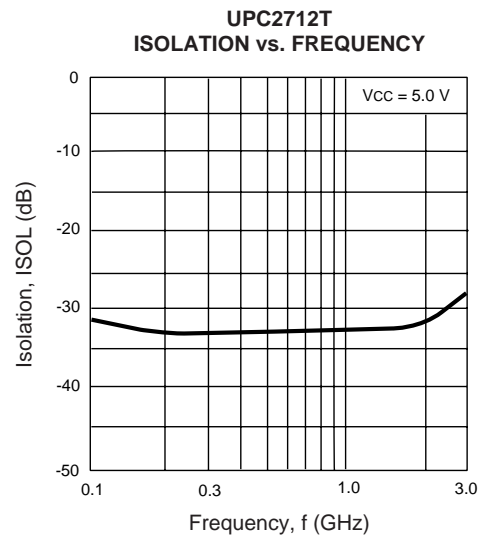
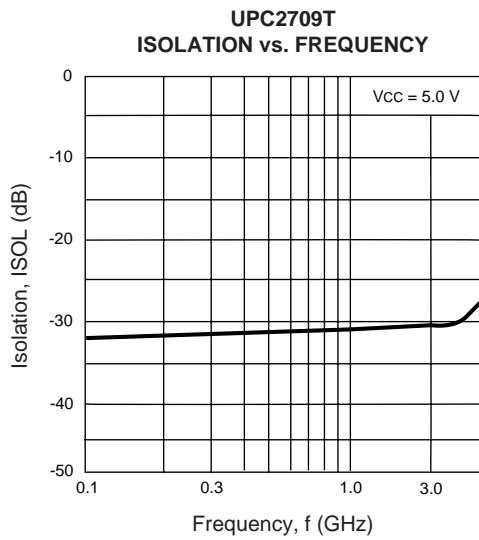
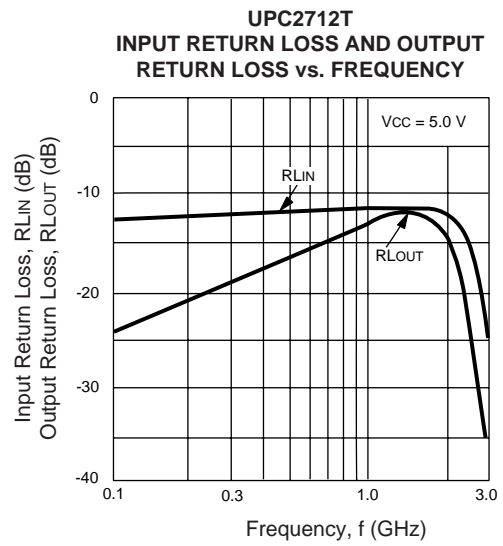
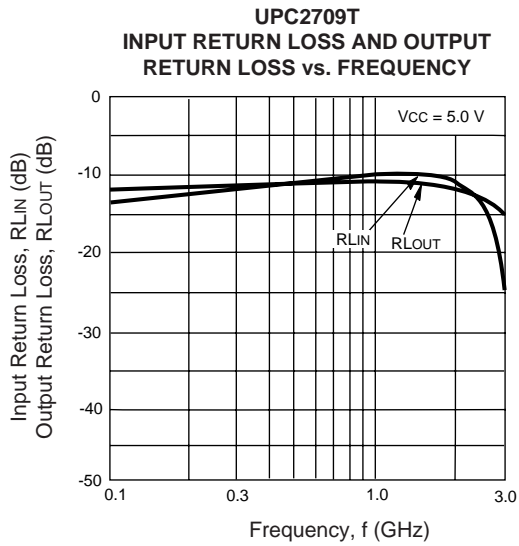

**TYPICAL PERFORMANCE CURVES** ( $T_A = 25^\circ\text{C}$ )

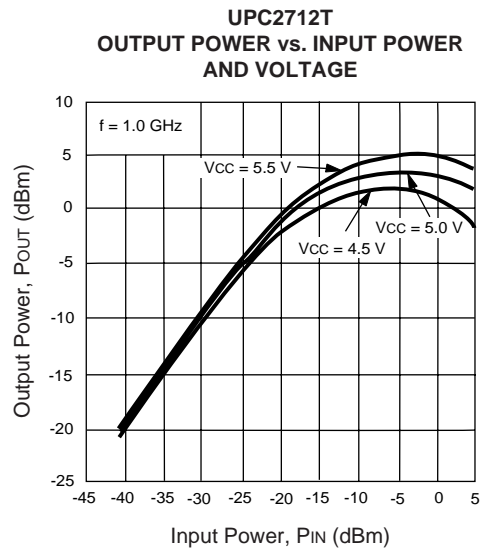
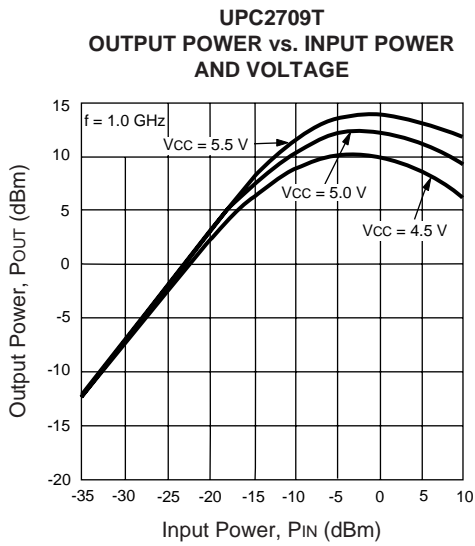
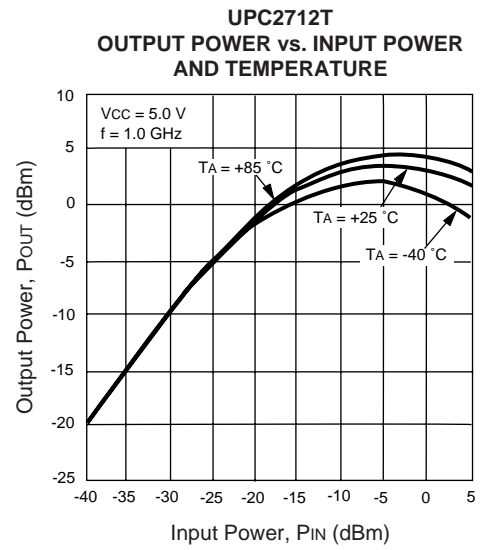
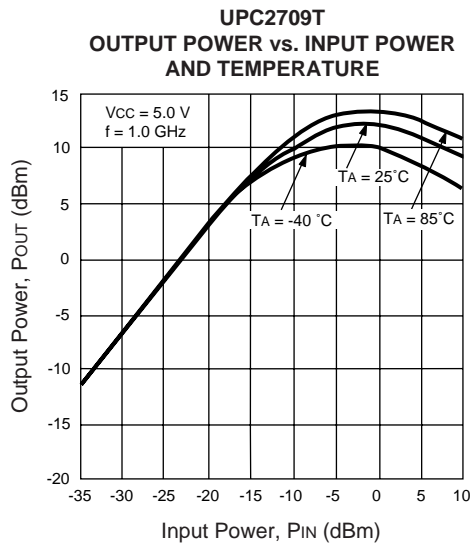

**TYPICAL SCATTERING PARAMETERS** (T<sub>A</sub> = 25°C)

**UPC2709T**

V<sub>CC</sub> = 5 V, I<sub>CC</sub> = 25 mA

FREQUENCY (GHz)	S <sub>11</sub>		S <sub>21</sub>		S <sub>12</sub>		S <sub>22</sub>		K <sup>1</sup>	S <sub>21</sub> (dB)
	MAG	ANG	MAG	ANG	MAG	ANG	MAG	ANG		
0.10	0.258	-4.1	12.7	-3.7	0.022	7.5	0.234	-4.6	1.66	22.1
0.20	0.261	-2.9	12.8	-12.2	0.024	3.1	0.240	-6.9	1.52	22.1
0.30	0.266	-3.4	12.9	-19.6	0.025	6.3	0.251	-9.6	1.45	22.2
0.40	0.271	-4.6	13.0	-27.0	0.025	6.5	0.260	-13.5	1.42	22.3
0.50	0.272	-6.8	13.1	-34.2	0.026	5.6	0.272	-17.9	1.36	22.3
0.60	0.275	-8.1	13.3	-41.3	0.026	10.5	0.288	-22.1	1.32	22.5
0.70	0.277	-10.4	13.5	-49.2	0.026	9.9	0.303	-28.6	1.29	22.6
0.80	0.278	-12.7	13.6	-57.4	0.026	11.0	0.312	-33.5	1.27	22.7
0.90	0.279	-14.0	13.7	-65.7	0.026	11.8	0.319	-38.4	1.25	22.7
1.00	0.279	-15.2	13.8	-72.3	0.027	15.6	0.324	-43.4	1.20	22.8
1.10	0.279	-18.1	13.9	-81.1	0.027	15.8	0.328	-51.2	1.19	22.9
1.20	0.276	-20.7	14.0	-90.3	0.027	17.7	0.332	-59.0	1.19	22.9
1.30	0.271	-23.3	13.9	-99.8	0.027	16.7	0.332	-67.1	1.20	22.9
1.40	0.263	-25.6	13.8	-109.3	0.027	19.2	0.326	-75.1	1.22	22.8
1.50	0.255	-26.9	13.6	-118.5	0.027	20.4	0.314	-82.5	1.25	22.7
1.60	0.246	-28.6	13.2	-128.3	0.028	20.6	0.302	-90.6	1.27	22.4
1.70	0.238	-30.2	12.7	-138.0	0.029	21.6	0.282	-98.9	1.30	22.1
1.80	0.237	-31.7	12.3	-147.5	0.030	27.9	0.254	-106.8	1.33	21.8
1.90	0.232	-33.1	11.7	-157.2	0.030	31.0	0.226	-113.6	1.40	21.4
2.00	0.222	-33.6	11.0	-166.1	0.031	33.2	0.198	-120.8	1.47	20.8
2.10	0.209	-34.4	10.3	-174.3	0.032	34.6	0.168	-126.7	1.54	20.3
2.20	0.194	-33.1	9.7	-177.5	0.033	35.8	0.143	-132.5	1.61	19.7
2.30	0.184	-30.3	9.0	-169.5	0.034	36.1	0.114	-137.7	1.69	19.1
2.40	0.176	-26.8	8.4	-162.0	0.034	38.5	0.089	-144.4	1.81	18.5
2.50	0.173	-23.2	7.8	-154.8	0.035	39.2	0.065	-150.6	1.90	17.8

**UPC2712T**

V<sub>CC</sub> = 5 V, I<sub>CC</sub> = 12 mA

FREQUENCY (GHz)	S <sub>11</sub>		S <sub>21</sub>		S <sub>12</sub>		S <sub>22</sub>		K <sup>1</sup>	S <sub>21</sub> (dB)
	MAG	ANG	MAG	ANG	MAG	ANG	MAG	ANG		
0.10	0.262	-9.3	9.3	-6.4	0.021	-1.6	0.071	7.8	2.46	19.3
0.20	0.261	-12.3	9.4	-17.4	0.022	-3.3	0.078	7.2	2.33	19.5
0.30	0.260	-17.0	9.5	-27.7	0.022	-5.1	0.091	6.4	2.29	19.6
0.40	0.258	-21.9	9.6	-37.5	0.023	-6.8	0.110	4.3	2.16	19.7
0.50	0.257	-27.1	9.8	-46.9	0.024	-8.5	0.128	-1.1	2.05	19.8
0.60	0.255	-32.0	9.9	-56.4	0.024	-10.2	0.146	-6.8	2.01	19.9
0.70	0.254	-38.1	10.0	-65.7	0.025	-12.0	0.166	-14.9	1.90	20.0
0.80	0.252	-41.9	10.2	-75.9	0.026	-13.7	0.181	-22.9	1.80	20.1
0.90	0.250	-46.5	10.3	-86.0	0.026	-15.4	0.194	-32.7	1.77	20.3
1.00	0.248	-51.0	10.4	-96.4	0.027	-17.2	0.204	-40.5	1.69	20.4
1.10	0.246	-57.5	10.6	-106.4	0.028	-18.9	0.212	-50.9	1.62	20.5
1.20	0.240	-62.5	10.6	-117.7	0.028	-20.6	0.221	-59.7	1.60	20.5
1.30	0.236	-67.8	10.7	-128.9	0.029	-22.3	0.235	-70.9	1.54	20.6
1.40	0.232	-72.4	10.8	-140.6	0.030	-24.1	0.244	-81.3	1.48	20.6
1.50	0.224	-77.7	10.8	-152.7	0.031	-25.8	0.247	-94.4	1.44	20.7
1.60	0.218	-82.1	10.9	-164.9	0.031	-27.5	0.246	-106.3	1.44	20.7
1.70	0.210	-86.2	10.9	-177.6	0.032	-29.3	0.240	-119.4	1.42	20.7
1.80	0.201	-89.3	10.7	-169.5	0.033	-31.0	0.234	-131.5	1.42	20.6
1.90	0.190	-93.5	10.5	-156.4	0.033	-32.7	0.221	-143.3	1.46	20.4
2.00	0.180	-96.9	10.3	-143.7	0.034	-34.4	0.210	-159.0	1.46	20.3
2.10	0.173	-98.4	10.0	-129.8	0.035	-36.2	0.187	-173.4	1.48	20.0
2.20	0.169	-101.3	9.7	-119.3	0.035	-37.9	0.169	-167.5	1.54	19.7
2.30	0.161	-100.3	8.8	-107.2	0.036	-39.6	0.156	-151.8	1.63	18.9
2.40	0.157	-100.0	8.4	-95.8	0.037	-41.3	0.134	-132.8	1.69	18.4
2.50	0.156	-99.4	7.7	-84.9	0.037	-43.1	0.125	-114.0	1.80	17.8
2.60	0.156	-100.0	7.3	-75.4	0.038	-44.8	0.118	-89.8	1.85	17.3
2.70	0.159	-98.4	6.8	-64.5	0.038	-46.5	0.108	-65.4	2.00	16.6
2.80	0.164	-101.7	6.5	-56.1	0.039	-48.3	0.110	-50.2	2.02	16.2
2.90	0.168	-100.1	5.8	-47.0	0.039	-50.0	0.122	-32.2	2.21	15.3
3.00	0.172	-101.1	5.5	-36.2	0.040	-51.7	0.136	-15.6	2.28	14.8

Note:

1. K factor calculations: 
$$K = \frac{1 + |\Delta|^2 - |S_{11}|^2 - |S_{22}|^2}{2 |S_{12} S_{21}|}$$
,  $\Delta = S_{11} S_{22} - S_{21} S_{12}$

**EQUIVALENT CIRCUIT**

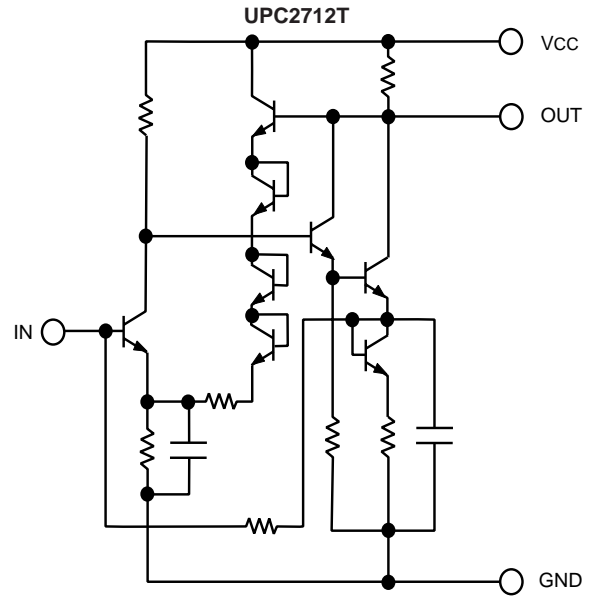
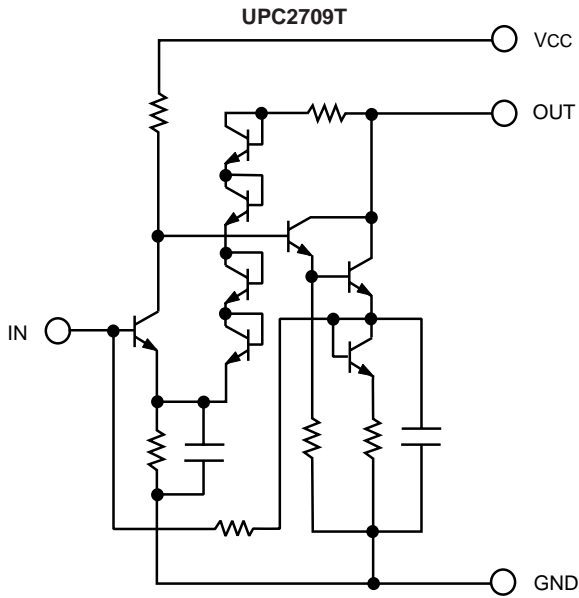

**OUTLINE DIMENSIONS (Units in mm)**

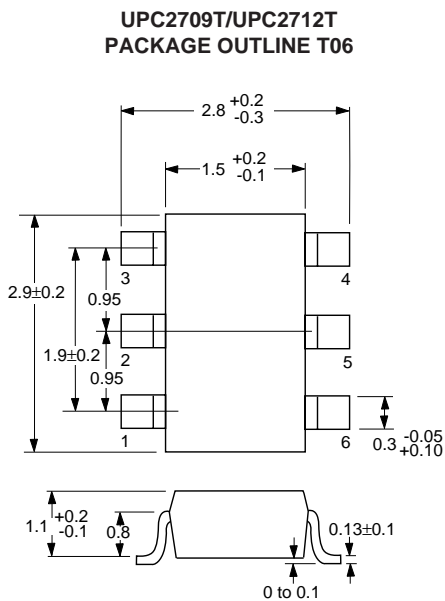

**LEAD CONNECTIONS**

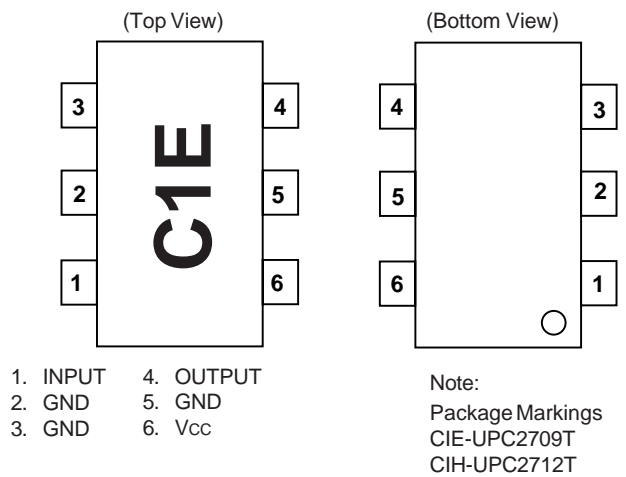

Note:  
All dimensions are typical unless otherwise specified.

**ORDERING INFORMATION (Solder Contains Lead)**

PART NUMBER	QTY
UPC2709T-E3	3K/Reel
UPC2712T-E3	3K/Reel

Embossed Tape, 8 mm wide.

**ORDERING INFORMATION (Pb-Free)**

PART NUMBER	QTY
UPC2709T-E3-A	3K/Reel
UPC2712T-E3-A	3K/Reel

Embossed Tape, 8 mm wide.

**RECOMMENDED P.C.B. LAYOUT (Units in mm)**

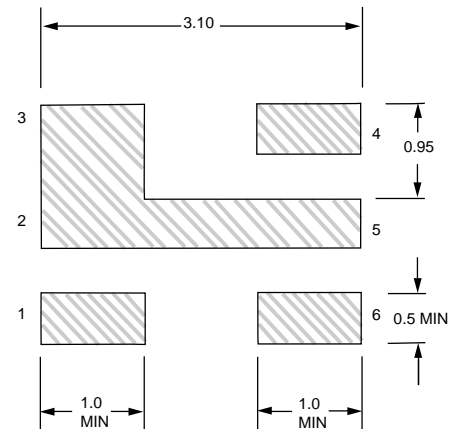

**Life Support Applications**

These NEC products are not intended for use in life support devices, appliances, or systems where the malfunction of these products can reasonably be expected to result in personal injury. The customers of CEL using or selling these products for use in such applications do so at their own risk and agree to fully indemnify CEL for all damages resulting from such improper use or sale.

Subject: Compliance with EU Directives

CEL certifies, to its knowledge, that semiconductor and laser products detailed below are compliant with the requirements of European Union (EU) Directive 2002/95/EC Restriction on Use of Hazardous Substances in electrical and electronic equipment (RoHS) and the requirements of EU Directive 2003/11/EC Restriction on Penta and Octa BDE.

CEL Pb-free products have the same base part number with a suffix added. The suffix –A indicates that the device is Pb-free. The –AZ suffix is used to designate devices containing Pb which are exempted from the requirement of RoHS directive (\*). In all cases the devices have Pb-free terminals. All devices with these suffixes meet the requirements of the RoHS directive.

This status is based on CEL’s understanding of the EU Directives and knowledge of the materials that go into its products as of the date of disclosure of this information.

Restricted Substance per RoHS	Concentration Limit per RoHS (values are not yet fixed)	Concentration contained in CEL devices	
		-A	-AZ
Lead (Pb)	< 1000 PPM	Not Detected	(*)
Mercury	< 1000 PPM	Not Detected	
Cadmium	< 100 PPM	Not Detected	
Hexavalent Chromium	< 1000 PPM	Not Detected	
PBB	< 1000 PPM	Not Detected	
PBDE	< 1000 PPM	Not Detected	

If you should have any additional questions regarding our devices and compliance to environmental standards, please do not hesitate to contact your local representative.

Important Information and Disclaimer: Information provided by CEL on its website or in other communications concerning the substance content of its products represents knowledge and belief as of the date that it is provided. CEL bases its knowledge and belief on information provided by third parties and makes no representation or warranty as to the accuracy of such information. Efforts are underway to better integrate information from third parties. CEL has taken and continues to take reasonable steps to provide representative and accurate information but may not have conducted destructive testing or chemical analysis on incoming materials and chemicals. CEL and CEL suppliers consider certain information to be proprietary, and thus CAS numbers and other limited information may not be available for release.

In no event shall CEL’s liability arising out of such information exceed the total purchase price of the CEL part(s) at issue sold by CEL to customer on an annual basis.

See CEL Terms and Conditions for additional clarification of warranties and liability.