

# **EKI-7626C/7626CI**

**Industrial 16+2G Combo Ports  
Unmanaged Redundant Fast  
Ethernet Switch**

**User Manual**

## **Copyright**

The documentation and the software included with this product are copyrighted 2007 by Advantech Co., Ltd. All rights are reserved. Advantech Co., Ltd. reserves the right to make improvements in the products described in this manual at any time without notice. No part of this manual may be reproduced, copied, translated or transmitted in any form or by any means without the prior written permission of Advantech Co., Ltd. Information provided in this manual is intended to be accurate and reliable. However, Advantech Co., Ltd. assumes no responsibility for its use, nor for any infringements of the rights of third parties, which may result from its use.

## **Acknowledgements**

Intel and Pentium are trademarks of Intel Corporation.  
Microsoft Windows and MS-DOS are registered trademarks of Microsoft Corp.  
All other product names or trademarks are properties of their respective owners.

## **Product Warranty (2 years)**

Advantech warrants to you, the original purchaser, that each of its products will be free from defects in materials and workmanship for two years from the date of purchase.

This warranty does not apply to any products which have been repaired or altered by persons other than repair personnel authorized by Advantech, or which have been subject to misuse, abuse, accident or improper installation. Advantech assumes no liability under the terms of this warranty as a consequence of such events.

Because of Advantech's high quality-control standards and rigorous testing, most of our customers never need to use our repair service. If an Advantech product is defective, it will be repaired or replaced at no charge during the warranty period. For out-of-warranty repairs, you will be billed according to the cost of replacement materials, service time and freight. Please consult your dealer for more details.

If you think you have a defective product, follow these steps:

1. Collect all the information about the problem encountered. (For example, CPU speed, Advantech products used, other hardware and software used, etc.) Note anything abnormal and list any onscreen messages you get when the problem occurs.
2. Call your dealer and describe the problem. Please have your manual, product, and any helpful information readily available.
3. If your product is diagnosed as defective, obtain an RMA (return merchandise authorization) number from your dealer. This allows us to process your return more quickly.
4. Carefully pack the defective product, a fully-completed Repair and Replacement Order Card and a photocopy proof of purchase date (such as your sales receipt) in a shippable container. A product returned without proof of the purchase date is not eligible for warranty service.
5. Write the RMA number visibly on the outside of the package and ship it prepaid to your dealer.

## Declaration of Conformity

### CE

This product has passed the CE test for environmental specifications. Test conditions for passing included the equipment being operated within an industrial enclosure. In order to protect the product from being damaged by ESD (Electrostatic Discharge) and EMI leakage, we strongly recommend the use of CE-compliant industrial enclosure products.

### FCC Class A

This equipment has been tested and found to comply with the limits for a Class A digital device, pursuant to Part 15 of the FCC Rules. These limits are designed to provide reasonable protection against harmful interference when the equipment is operated in a commercial environment. This equipment generates, uses and can radiate radio frequency energy and, if not installed and used in accordance with the instruction manual, may cause harmful interference to radio communications. Operation of this equipment in a residential area is likely to cause harmful interference in which case the user will be required to correct the interference at his own expense.

## Technical Support and Assistance

- Step 1. Visit the Advantech web site at [www.avanotech.com/support](http://www.avanotech.com/support) where you can find the latest information about the product.
- Step 2. Contact your distributor, sales representative, or Advantech's customer service center for technical support if you need additional assistance. Please have the following information ready before you call:
  - Product name and serial number
  - Description of your peripheral attachments
  - Description of your software (operating system, version, application software, etc.)
  - A complete description of the problem
  - The exact wording of any error messages

## Safety Instructions

1. Read these safety instructions carefully.
2. Keep this User's Manual for later reference.
3. Disconnect this equipment from any AC outlet before cleaning. Use a damp cloth. Do not use liquid or spray detergents for cleaning.
4. For plug-in equipment, the power outlet socket must be located near the equipment and must be easily accessible.
5. Keep this equipment away from humidity.
6. Put this equipment on a reliable surface during installation. Dropping it or letting it fall may cause damage.
7. The openings on the enclosure are for air convection. Protect the equipment from overheating. **DO NOT COVER THE OPENINGS.**
8. Make sure the voltage of the power source is correct before connecting the equipment to the power outlet.
9. Position the power cord so that people cannot step on it. Do not place anything over the power cord.
10. All cautions and warnings on the equipment should be noted.
11. If the equipment is not used for a long time, disconnect it from the power source to avoid damage by transient overvoltage.
12. Never pour any liquid into an opening. This may cause fire or electrical shock.
13. Never open the equipment. For safety reasons, the equipment should be opened only by qualified service personnel.
14. If one of the following situations arises, get the equipment checked by service personnel:
  - a. The power cord or plug is damaged.
  - b. Liquid has penetrated into the equipment.
  - c. The equipment has been exposed to moisture.
  - d. The equipment does not work well, or you cannot get it to work according to the user's manual.
  - e. The equipment has been dropped and damaged.
  - f. The equipment has obvious signs of breakage.
15. **DO NOT LEAVE THIS EQUIPMENT IN AN ENVIRONMENT WHERE THE STORAGE TEMPERATURE MAY GO BELOW  $-40^{\circ}\text{C}$  ( $-40^{\circ}\text{F}$ ) OR ABOVE  $85^{\circ}\text{C}$  ( $185^{\circ}\text{F}$ ). THIS COULD DAMAGE THE EQUIPMENT. THE EQUIPMENT SHOULD BE IN A CONTROLLED ENVIRONMENT.**

## **Safety Precaution - Static Electricity**

Follow these simple precautions to protect yourself from harm and the products from damage.

1. To avoid electrical shock, always disconnect the power from your PC chassis before you work on it. Don't touch any components on the CPU card or other cards while the PC is on.
2. Disconnect power before making any configuration changes. The sudden rush of power as you connect a jumper or install a card may damage sensitive electronic components.

# Contents

<b>Chapter 1</b>	<b>Overview.....</b>	<b>2</b>
1.1	Introduction .....	2
1.1.1	The SFP Advantage .....	2
1.1.2	High-Speed Transmissions .....	2
1.1.3	Dual Power Input .....	2
1.1.4	Flexible Mounting .....	2
1.1.5	Advanced Protection .....	2
1.1.6	Wide Operating Temperature .....	3
1.1.7	Easy Troubleshooting.....	3
1.2	Features.....	4
1.3	Specification .....	5
1.4	Packing List .....	7
1.5	Safety Precaution .....	7
<b>Chapter 2</b>	<b>Installation.....</b>	<b>10</b>
2.1	LED Indicators .....	10
	Table 2.1: EKI-7626C/7626CI LED Definition .....	10
2.2	Dimensions (units: mm) .....	11
	Figure 2.1: Front View of EKI-7626C/7626CI .....	11
	Figure 2.2: Side View of EKI-7626C/7626CI.....	12
	Figure 2.3: Rear View of EKI-7626C/7626CI .....	13
	Figure 2.4: Top View of EKI-7626C/7626CI .....	14
2.3	Mounting .....	15
2.3.1	Wall mounting.....	15
	Figure 2.5: Combine the Metal Mounting Kit.....	15
2.3.2	DIN-rail Mounting.....	16
	Figure 2.6: Installation to DIN-rail Step 1.....	16
	Figure 2.7: Installation to DIN-rail Step 2.....	17
2.4	Network Connection .....	18
2.5	Connection to a Fiber Optic Network .....	18
	Figure 2.8: Transceiver to the SFP module .....	18
	Figure 2.9: Transceiver Inserted.....	19
	Figure 2.10: LC connector to the transceiver .....	19
	Figure 2.11: Remove LC connector .....	20
	Figure 2.12: Pull out from the transceiver.....	20
2.6	Power Connection .....	21
	Figure 2.13: Pin Assignment of the Power Connector .....	21
<b>Chapter 3</b>	<b>Troubleshooting .....</b>	<b>24</b>
<b>Appendix A</b>	<b>Pin Assignment &amp; Wiring .....</b>	<b>26</b>
	Figure A.1: RJ-45 Pin Assignment.....	26
	Figure A.2: EIA/TIA-568B .....	26
	Figure A.2: EIA/TIA-568A .....	26
<b>Appendix B</b>	<b>Compatible SFP Modules .....</b>	<b>28</b>





## Overview

Sections include:

- Introduction
- Features
- Specifications
- Packing List
- Safety Precaution

# Chapter 1 Overview

## 1.1 Introduction

---

Aside from 16 x 10/100Base-TX fast Ethernet ports, the EKI-7626C/7626CI comes equipped with 2 combo 10/100/1000 Mbps RJ-45 copper ports/mini-GBIC expansion ports. Traditional RJ-45 ports can be used for uplinking wide-band paths in short distance (< 100 m), or the appropriate replaceable SFP module can be used for the application of wideband uploading and long distance transmissions to fit the field request flexibility. Also, the long MTBF (Mean Time Between Failures) ensures that the EKI-7626C/7626CI will continue to operate until a Gigabit network infrastructure has been established, without requiring any extra upgrade costs.

### 1.1.1 The SFP Advantage

The EKI-7626C/7626CI's two SFP fiber slots provide a lot of flexibility when planning and implementing a network. The slots can accept any SFP-type fiber module and these modules are designed for transmitting over distances of either 500m (multi-mode), 10km, 30km, 50km, 70km or 110km (single-mode)—and the slots support SFP modules for WDM single-fiber transmissions. This means that you can easily change the transmission mode and distance of the switch by simply pulling out the SFP module and plugging in a different module. The SFP modules are hot-swappable and plug-and-play! Also, the fact that the switch has two of these slots, means that the network manager can, for example, have one 10km module in one slot and one 110km in the other.

### 1.1.2 High-Speed Transmissions

The EKI-7626C/7626CI includes a switch controller that can automatically sense transmission speeds (10/100 Mbps). The RJ-45 interface can also be auto-detected, so MDI or MDI-X is automatically selected and a crossover cable is not required.

### 1.1.3 Dual Power Input

To reduce the risk of power failure, the EKI-7626C/7626CI provides +12 ~ 48 V<sub>DC</sub> dual power inputs. When one of the power inputs fails, P-Fail LED will turn on and send an alarm through a relay output for notifying the user; and the switch will toggle to the secondary power input.

### 1.1.4 Flexible Mounting

EKI-7626C/7626CI is compact and can be mounted on a DIN-rail or panel, so it is suitable for any space-constrained environment.

### 1.1.5 Advanced Protection

The power line of EKI-7626C/7626CI supports up to 3,000 V<sub>DC</sub> EFT protection, which secure equipment against unregulated voltage and make systems safer and more reliable. Meanwhile, 4,000 V<sub>DC</sub> ESD protections for Ethernet ports make EKI-7626C/7626CI more suitable for harsh environments.

### **1.1.6 Wide Operating Temperature**

The operating temperature of the EKI-7626C is between -10 ~ 60°C and EKI-7626CI is between -40 ~ 75°C. With such a wide range, you can use the EKI-7626C/7626CI in some of the harshest industrial environments that exist.

### **1.1.7 Easy Troubleshooting**

LED indicators make troubleshooting quick and easy. Each 10/100 Base-TX port has 2 LEDs that display the link status, transmission speed and collision status. Also the three power indicators PWR1, PWR2 and P-Fail help you diagnose immediately.

## 1.2 Features

---

- System Interface/Performance
  - RJ-45 ports support Auto MDI/MDI-X Function
  - SFP (mini-GBIC) supports 100/1000 Dual Mode
  - Store-and-Forward Switching Architecture
  - Back-plane (Switching Fabric): 7.2Gbps
  - 1Mbits Packet Buffer
  - 8K MAC Address Table
  - Supports Wide Operating Temperature (-40°C ~ 75°C)
- Power Supply
  - Wide Range Redundant Power Design
  - Power Polarity Reverse Protect
  - Overload Current Protection
- Case/Installation
  - IP-30 Protection
  - DIN-Rail and Wall Mount Design
- Provides EFT protection 3,000 VDC for power line
- Supports 4,000 VDC Ethernet ESD protection

## 1.3 Specification

---

### Communications

<b>IEEE Standard LAN</b>	IEEE 802.3, 802.3ab, 802.3u, 802.3x, 802.3z 10/100/1000Base-TX, Optional 100Base-FX, 1000Base-SX/LX/LHX/XD/ZX/EZX
<b>Transmission Distance</b>	Ethernet: Up to 100m (4-wire Cat.5e, Cat.6 RJ-45 cable suggested for Gigabit port) SFP: Up to 110km (depends on SFP)
<b>Transmission Speed</b>	Ethernet: 10/100Mbps, Auto-Negotiation Gigabit Copper: Up to 1000 Mbps Gigabit Fiber: Up to 1000Mbps

### Interface

<b>Connectors</b>	16 x RJ-45 (Ethernet) 2 x RJ-45/SFP (mini-GBIC) combo ports 6-pin removable screw terminal (power & Relay)
<b>LED Indicators</b>	System: PWR1, PWR2, P-Fail 10/100TX: Link/Activity, Duplex/Collision Gigabit Copper: Link/Activity, Speed (1000Mbps) SFP: Link/Activity

### Power

<b>Power Consumption</b>	Max. 8 W
<b>Power Input</b>	2 x Unregulated +12 ~ 48 V <sub>DC</sub>
<b>Fault Output</b>	1 Relay Output

### Mechanism

<b>Dimensions (WxHxD)</b>	79 x 152 x 105 mm
<b>Enclosure</b>	IP30, metal shell with solid mounting kits
<b>Mounting</b>	DIN-rail, wall

### Protection

<b>ESD (Ethernet)</b>	4,000 V <sub>DC</sub>
<b>Surge (EFT for power)</b>	3,000 V <sub>DC</sub>
<b>Reverse Polarity</b>	Present
<b>Overload</b>	3.5A / 12 V <sub>DC</sub> (Fuse)

## Environment

### **Operating Temperature**

Standard model: -10 ~ 60°C (14 ~ 140°F)

Wide temp. model: -40 ~ 75°C (-40 ~ 167°F)

### **Operating Humidity**

5 ~ 95% (non-condensing)

### **Storage Temperature**

-40 ~ 85°C (-40 ~ 185°F)

### **Storage Humidity**

0 ~ 95% (non-condensing)

### **MTBF**

284,409 hours

## Certifications

### **Safety**

UL, 60950-1, CAN/CSA-C22.2 No.60950

### **EMC**

EU: EN55011, EN61000-6-4

EN55022, Class A,

EN61000-3-2/3

EN55024

IEC61000-4-2/3/4/5/6/8

EN61000-6-2

EN61000-6-4

### **Freefall**

IEC60068-2-32

### **Shock**

IEC60068-2-27

### **Vibration**

IEC60068-2-6

## 1.4 Packing List

---

- 1 x EKI-7626C/7626CI Industrial Switch
- 1 x eAutomation Industrial Communication CD-ROM with software, and User manual
- 2 x Wall Mounting Bracket and Screws
- 1 x DIN-rail Mounting Bracket and Screws
- 1 x DC Jack cable  $\varphi$  2.0/150mm
- 1 x EKI-7626C/7626CI Startup Manual

## 1.5 Safety Precaution

---

*Attention*    *IF DC voltage is supplied by an external circuit, please use a protection device on the power supply input.*





# CHAPTER 2

## Installation

Sections include:

- LED Indicators
- Dimensions
- Mounting
- Network Connection
- Connection to a Fiber Optic Network
- Power Connection

## Chapter 2 Installation

In this chapter, you will be given an overview of the EKI-7626C/7626CI hardware installation procedures.

### 2.1 LED Indicators

There are few LEDs display the power status and network status located on the front panel of EKI-7626C/7626CI, each of them has its own specific meaning shown as below.

<i>Table 2.1: EKI-7626C/7626CI LED Definition</i>			
LED	Color	Description	
PWR1	Green	On	Power input 1 is active
		Off	Power input 1 is inactive
PWR2	Green	On	Power input 2 is active
		Off	Power input 2 is inactive
P-Fail	Red	On	Power input 1 or 2 is inactive
		Off	Power input 1 and 2 are both active, or no power input
Link/Active (for G17, G18 SFP)	Green	On	SFP port is linking
		Flashing	Data is transmitting or receiving
		Off	Not connected to network
G17, G18 (RJ-45)	Green (Upper LED)	On	Connected to network
		Flashing	Networking is active
		Off	Not connected to network
	Green (Lower LED)	On	The port is operating at speed of 1000M
		Off	The port is disconnected or not operating at speed of 1000M
1 ~ 16 (10/100TX)	Green (Upper LED)	On	Connected to network
		Flashing	Networking is active
		Off	Not connected to network
	Yellow (Lower LED)	On	Ethernet port full duplex
		Flashing	Collision of packets occurs
		Off	Ethernet port half duplex or not connect to network

## 2.2 Dimensions (units: mm)

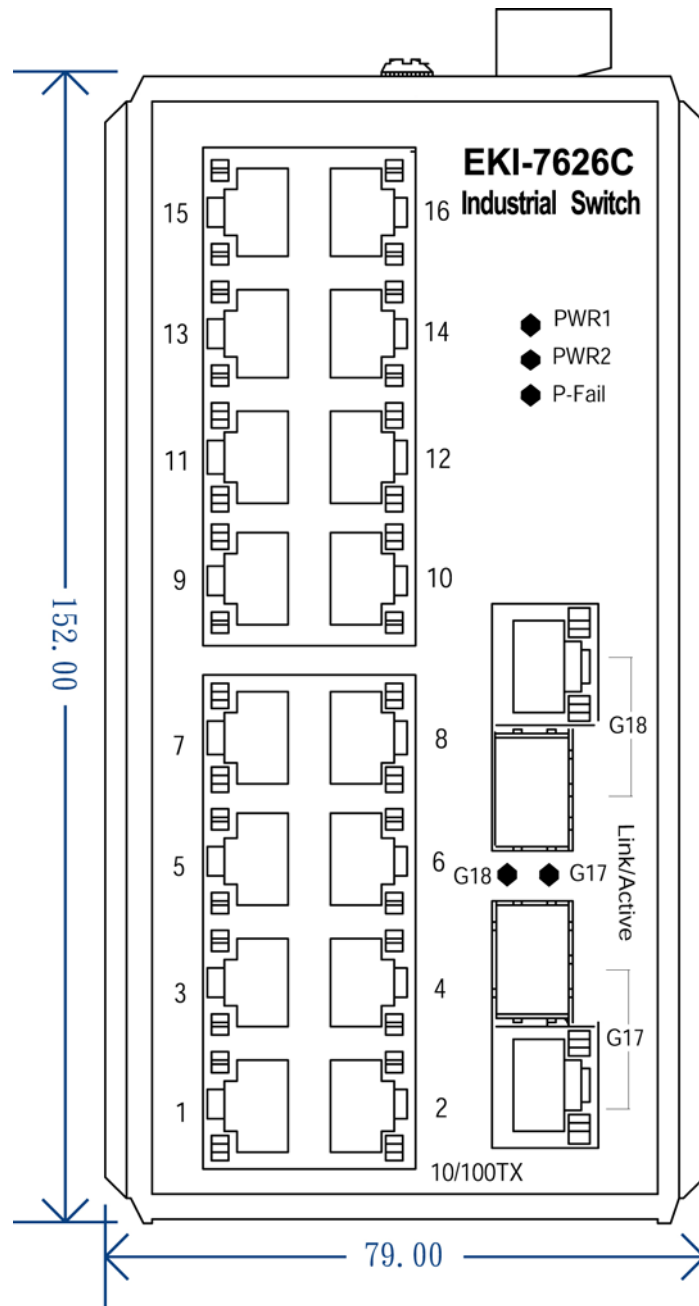

Figure 2.1: Front View of EKI-7626C/7626CI

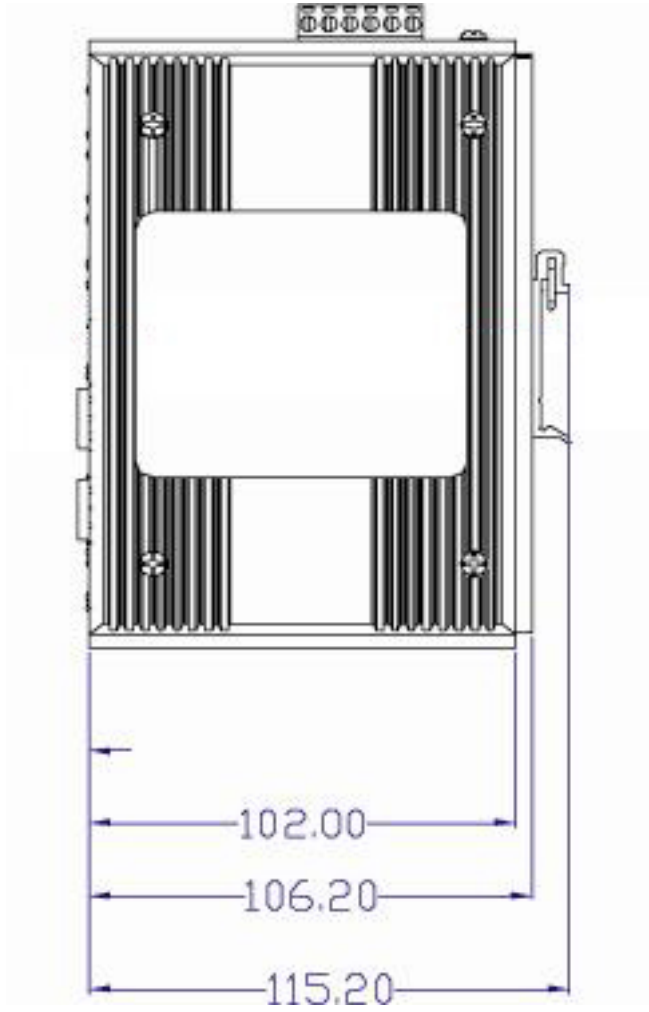

Figure 2.2: Side View of EKI-7626C/7626CI

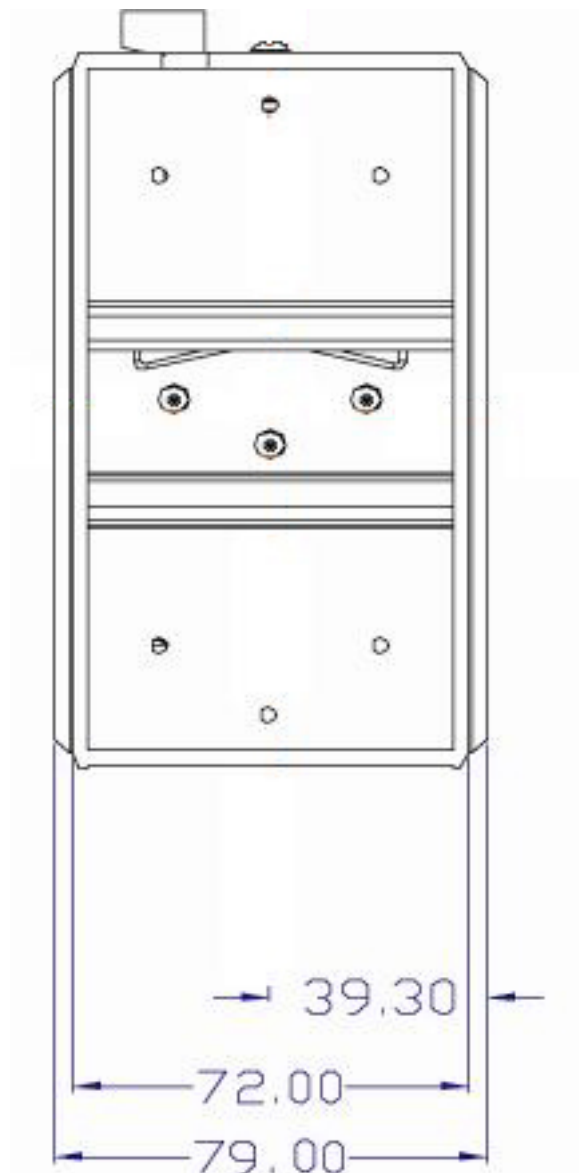

Figure 2.3: Rear View of EKI-7626C/7626CI

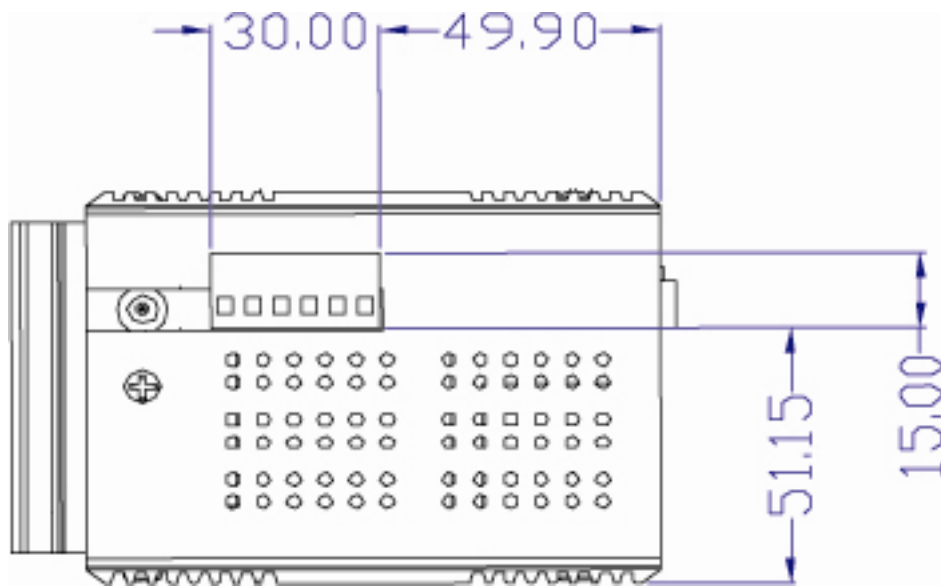

Figure 2.4: Top View of EKI-7626C/7626CI

## 2.3 Mounting

The EKI-7626C/7626CI supports two mounting methods: DIN-rail & Wall.

### 2.3.1 Wall mounting

EKI-7626C/7626CI can be wall-mounted by using the included mounting kit. Then, hang on the EKI-7626C/7626CI to the nails on the wall.

First, use the screws included in the package to combine the EKI-7626C/7626CI and metal mounting kit. And then you can install the device firmly via the components, please see Figure 2.5 as below.



Figure 2.5: Combine the Metal Mounting Kit

### 2.3.2 DIN-rail Mounting

You can also mount EKI-7626C/7626CI on a standard DIN-rail by below steps.

The DIN-rail kit is screwed on the industrial switch when out of factory. If the DIN-rail kit is not screwed on the industrial switch, please screw the DIN-rail kit on the switch first.

First, hang the EKI-7626C/7626CI to the DIN-rail with angle of inclination. See Figure 2.6.



*Figure 2.6: Installation to DIN-rail Step 1*



Then, let the device down straight to slide over the rail smoothly. See Figure 2.7.



*Figure 2.7: Installation to DIN-rail Step 2*

## 2.4 Network Connection

---

The EKI-7626C/7626CI has 16 x RJ-45 ports that support connection to 10 Mbps Ethernet, or 100 Mbps Fast Ethernet, and half or full duplex operation. EKI-7626C/7626CI can be connected to other hubs or switches via a twisted-pair straight-through or crossover cable up to 100m long. The connection can be made from any TX port of the EKI-7626C/7626CI (MDI-X) to another hub or switch either MDI-X or uplink MDI port.

The EKI-7626C/7626CI supports auto-crossover to make networking more easy and flexible. You can connect any RJ-45 (MDI-X) station port on the switch to any device such as a switch, bridge or router.

## 2.5 Connection to a Fiber Optic Network

---

EKI-7626C/7626CI has two SFP slots for connecting to the network segment with single or multi-mode fiber. You can choose appropriate mini-GBIC module to plug into the slot. Make sure the module is aligned correctly and then slide the module into the SFP slot until a click is heard. You can use proper multi-mode or single-mode fiber according to the used SFP module. With fiber optic, it transmits speed up to 1,000 Mbps and you can prevent noise interference from the system and transmission distance up to 110 km, depending on the mini-GBIC module.

The small form-factor pluggable (SFP) is a compact optical transceiver used in optical communications for both telecommunication and data communications applications.

**Note** *The SFP/Copper Combo port can't be used at the same time. The SFP port has the higher priority than copper port; if you insert the 1000M SFP transceiver into the SFP port which is connected to the remote device, the connection of the accompanying copper port will link down.  
If you insert the 100M SFP transceiver into the SFP port even without a fiber connection to the remote, the connection of the accompanying copper port will link down immediately.*

To connect the transceiver and LC cable, please follow the steps shown below:

First, insert the transceiver into the SFP module. Note that the location of the triangle indicates the bottom of the module.

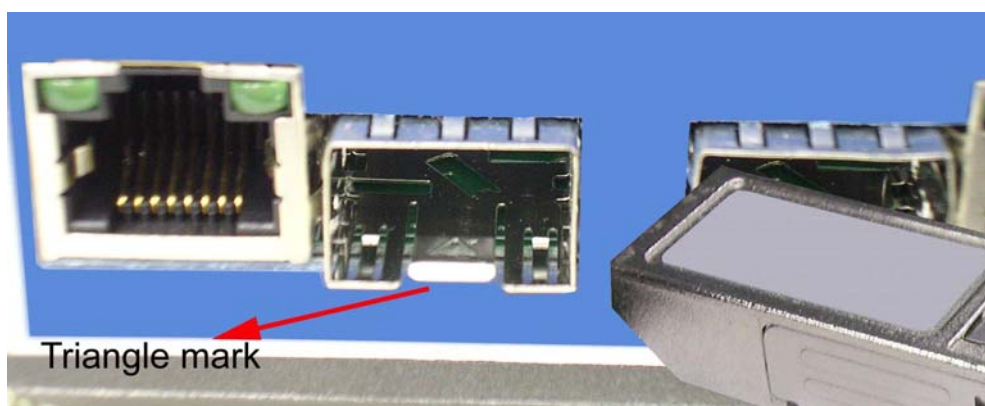
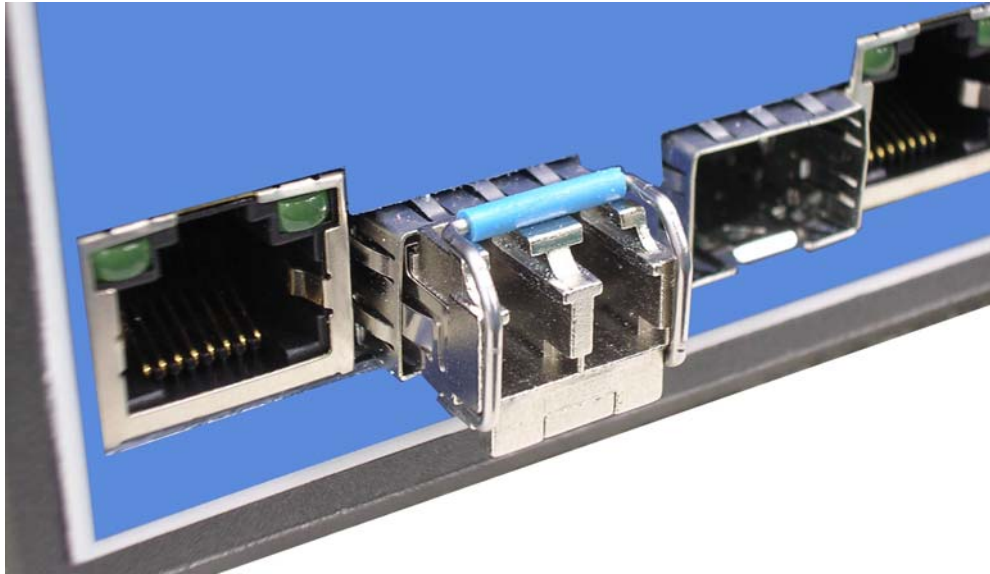

Figure 2.8: Transceiver to the SFP module



*Figure 2.9: Transceiver Inserted*

Second, insert the fiber cable of LC connector into the transceiver.



*Figure 2.10: LC connector to the transceiver*

To remove the LC connector from the transceiver, please follow the steps shown below:

First, press the upper side of the LC connector to release from the transceiver and pull it out.

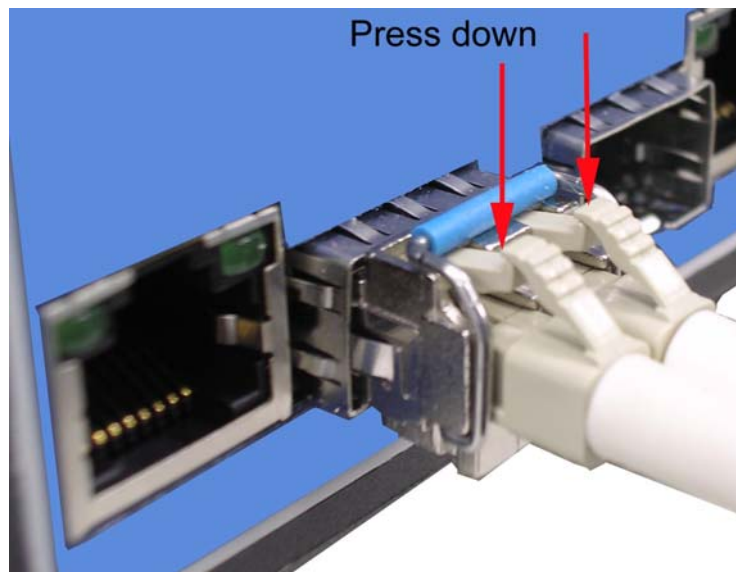

*Figure 2.11: Remove LC connector*

Second, push down the metal loop and pull the transceiver out by the plastic handle.

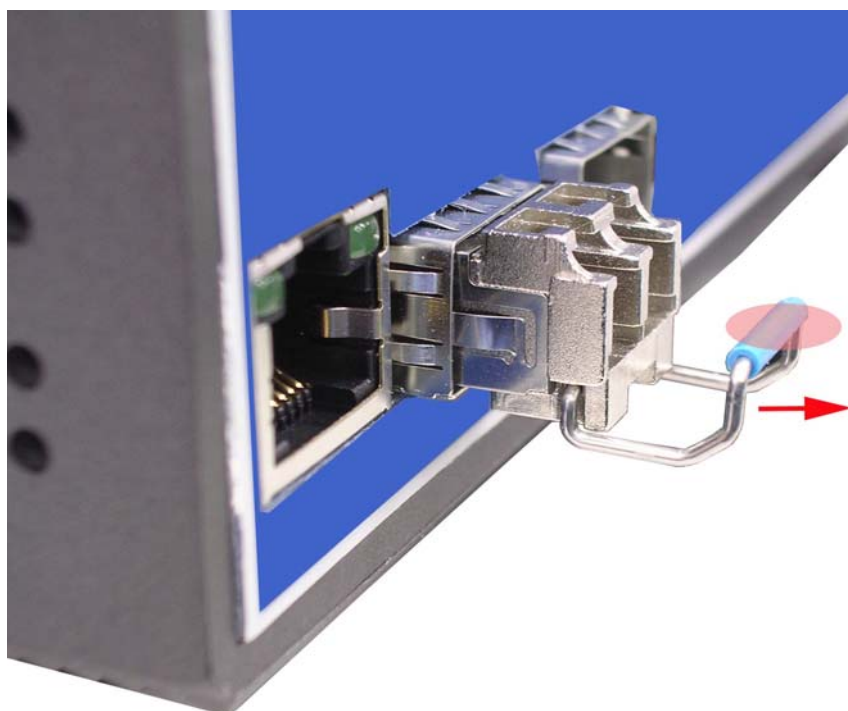

*Figure 2.12: Pull out from the transceiver*

## 2.6 Power Connection

---

The EKI-7626C/7626CI supports dual +12 ~ 48 V<sub>DC</sub> power inputs and power-fail relay output.

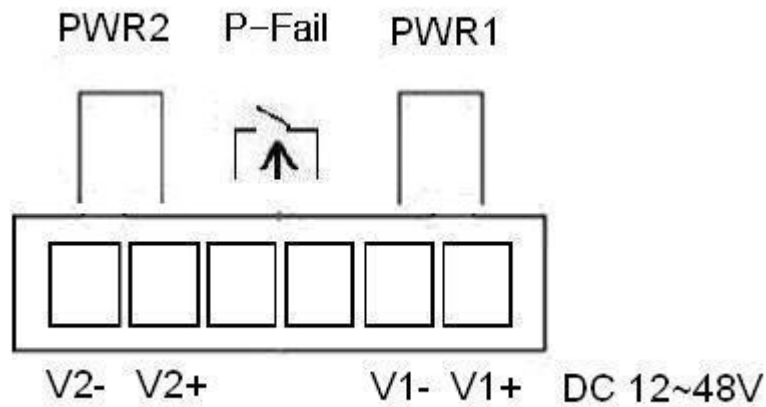

Figure 2.13: Pin Assignment of the Power Connector

You can connect an alarm indicator, buzzer or other signaling equipment through the relay output. The relay opens if power input 1, 2 fails or port link down/break ("Open" means if you connect relay output with an LED, the light would be off).



CHAPTER  
3

# Troubleshooting

## Chapter 3 Troubleshooting

Verify that you are using the right power cord/adaptor (+12 ~ 48 V<sub>DC</sub>), please don't use the power adaptor with DC output voltage higher than 48 V, or it will burn this converter down.

Select the proper UTP cable to construct the user network. Use unshielded twisted-pair (UTP) or shield twisted-pair (STP) cable for RJ-45 connections: 100  $\Omega$  Category 3, 4 or 5 cable for 10Mbps connections, 100  $\Omega$  Category 5 cable for 100Mbps connections, or 100  $\Omega$  Category 5e/above cable for 1000Mbps connections. Also be sure that the length of any twisted-pair connection does not exceed 100 meters (328 feet).

### Diagnosing LED Indicators

To assist in identifying problems, the switch can be easily monitored through panel indicators, which describe common problems the user may encounter and where the user can find possible solutions.

If the power indicator does not light on when the power cord is plugged in, you may have a problem with power cord. Then check for loose power connections, power losses or surges at power outlet. If you still cannot resolve the problem, contact the local dealer for assistance.

If the LED indicators are normal and the connected cables are correct but the packets still cannot be transmitted. Please check the user system's Ethernet devices' configuration or status.



**APPENDIX  
A**

**Pin Assignment &  
Wiring**

# Appendix A Pin Assignment & Wiring

It is suggested to adopt ELA/TIA as the wiring of the RJ-45.

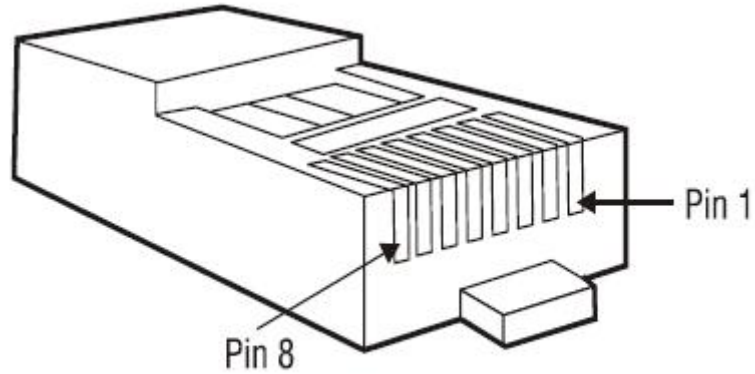

Figure A.1: RJ-45 Pin Assignment

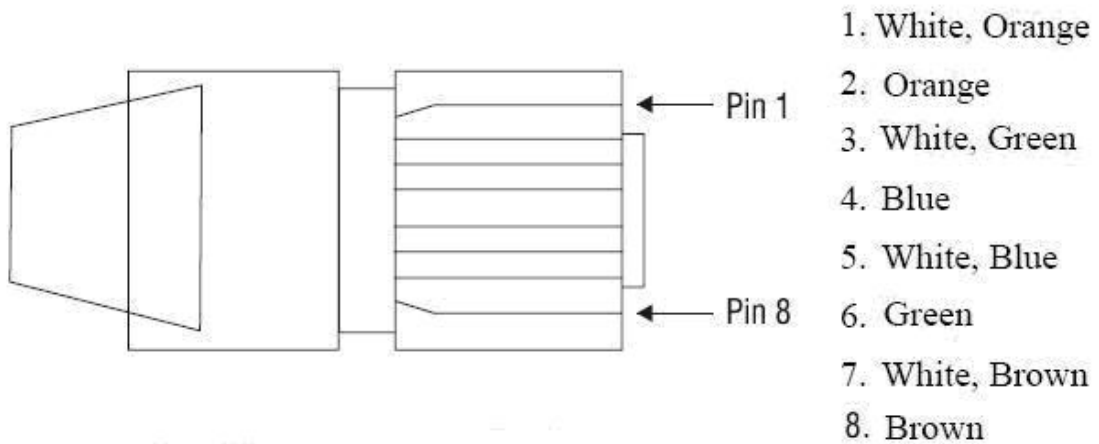

Figure A.2: EIA/TIA-568B

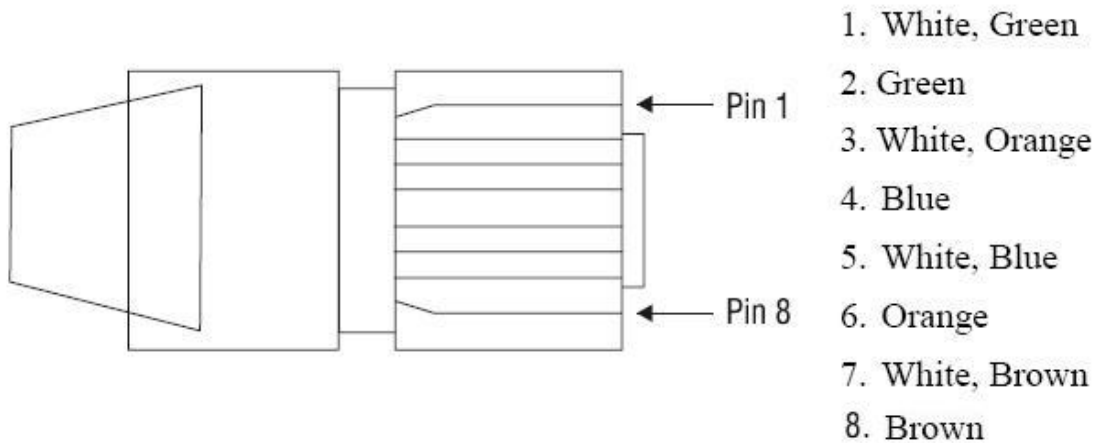

Figure A.2: EIA/TIA-568A

APPENDIX  
**B**

**Compatible SFP  
Modules**

## Appendix B Compatible SFP Modules

The table below shows compatible SFP modules for EKI-7626C/7626CI.

Item	Brand	Part Number	Mode	Transmission Distance
1	AVAGO	AFBR-5710PZ	Multi-mode	550m
2	APAC	LM28-C3S-TC-N		550m
3	HOATECH	HTI8512-X5ATO		550m
4	SPACE SHUTTLE	S56L-S85-6L-N		550m
5	LuminentOIC	SP-GB-LX	Single-mode	10km
		SP-GB-ELX		20km
		SP-GB-XD		50km
6	AVAGO	AFCT-5710PZ		10km
7	APAC	LS38-C3M-TC-N		20km
8	SPACE SHUTTLE	S56L-L13-6L-N		10km