

85mΩ High Function Power Switch

■ GENERAL DESCRIPTION

The XC8109 series is a P-channel MOSFET power switch IC with a low ON resistance. A current limit, reverse current prevention (prevents reverse current from V_{OUT} to V_{IN}), soft start, thermal shutdown, and an under voltage lockout (UVLO) are incorporated as protective functions. A flag function monitors the power switch status. The flag output has N-channel open drain structure, and outputs Low level signal while over-current or overheating is detected, or while the reverse current prevention is operated.

A variable current limiting function is integrated, allowing the current limit value to be set, using an external resistor. The voltage level which is fed to CE pin determines the status of XC8109. The logic level of CE pin is selectable between either one of active high or active low.

■ APPLICATIONS

- Set Top Boxes
- Digital TVs
- PCs
- USB Ports/USB Hubs
- HDMI

■ FEATURES

| | |
|-------------------------------|--|
| Input Voltage | : 2.5V~5.5V |
| Maximum Output Current | : 0.9A |
| ON Resistance | : 85mΩ@ $V_{IN}=5.0V$ (TYP.) |
| Supply Current | : 40μA@ $V_{IN}=5.0V$ |
| Stand-by Current | : 0.1μA (TYP.) |
| Flag Delay Time | : 7.5ms (TYP.) |
| | * At over-current detection |
| | : 4ms (TYP.) |
| | * At reverse voltage detection |
| Protection Circuit | : Reverse Current Prevention 75mA~1.3A (TYP.) Thermal Shutdown Under Voltage Lockout (UVLO) Soft-start |
| Functions | : Flag Output CE Pin Input Logic Selectable |
| Current Limit Response Time | : 2μs (TYP.) *Reference value |
| Operating Ambient Temperature | : -40°C~+105°C |
| Package | : USP-6C |
| Environmentally Friendly | : EU RoHS Compliant, Pb Free |

■ TYPICAL APPLICATION CIRCUIT

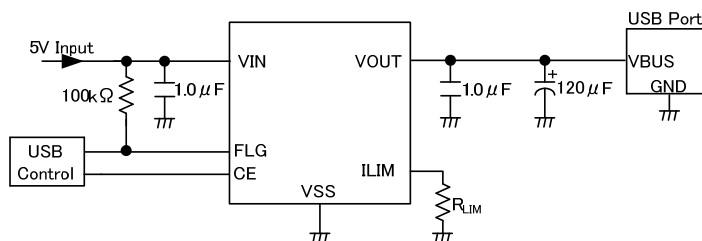

* The Typical circuit is base on USB high side switch.
The XC8109 series can accommodate 1μF output capacitor (C_L).

■ TYPICAL PERFORMANCE CHARACTERISTICS

XC8109xC10ER

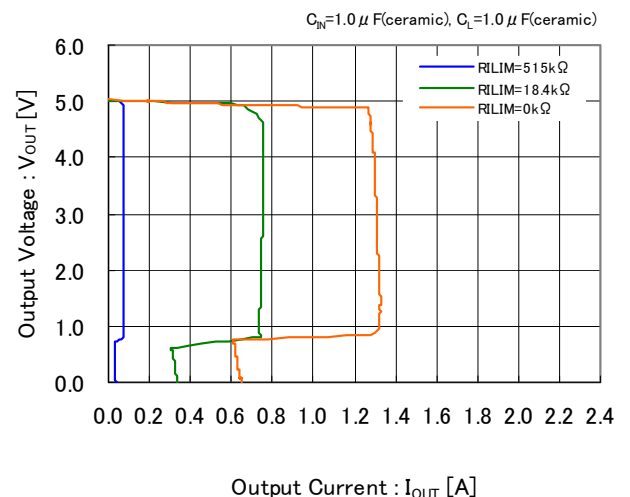

■ BLOCK DIAGRAM

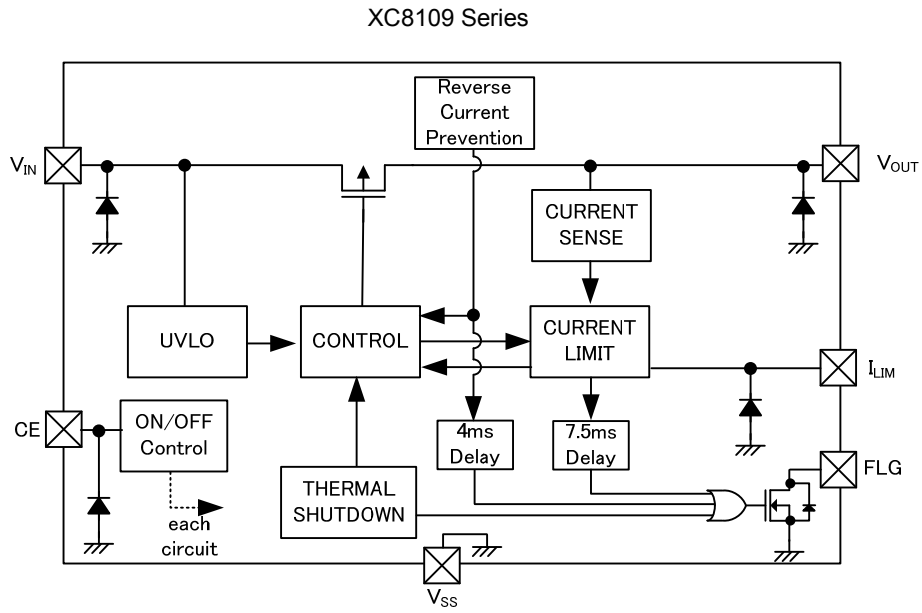

* Diodes inside the circuit are an ESD protection diode and a parasitic diode.

■ PRODUCT CLASSIFICATION

● Ordering Information

XC8109①②③④⑤⑥-⑦

| DESIGNATOR | ITEM | SYMBOL | DESCRIPTION |
|------------|--------------------------|--------|--|
| ① | CE Logic | A | Refer to Selection Guide |
| | | B | |
| ② | Protection Circuits Type | C | |
| | | D | |
| ③④ | Maximum Output Current | 10 | 0.9A (* Adjustable current limit range:75mA~1300mA) |
| ⑤⑥-⑦ (*1) | Package (Order Unit) | ER-G | USP-6C (3,000/Reel) |

(*1) The "-G" suffix denotes Halogen and Antimony free as well as being fully EU RoHS compliant.

● Selection Guide

| TYPE | CE LOGIC SELECTABLE | SOFT-START | CURRENT LIMIT ADJUSTABLE |
|------|---------------------|------------|--------------------------|
| AC | Active High | Yes | Yes |
| AD | Active High | Yes | Yes |
| BC | Active Low | Yes | Yes |
| BD | Active Low | Yes | Yes |

| TYPE | UVLO | FLG OUTPUT | REVERSE CURRENT PREVENTION |
|------|------|------------|----------------------------|
| AC | Yes | Yes | Yes |
| AD | Yes | Yes | Yes |
| BC | Yes | Yes | Yes |
| BD | Yes | Yes | Yes |

| TYPE | THERMAL SHUT DOWN | LATCH PROTECTION |
|------|-------------------|------------------|
| AC | Yes | No |
| AD | Yes | Yes |
| BC | Yes | No |
| BD | Yes | Yes |

■ PIN CONFIGURATION

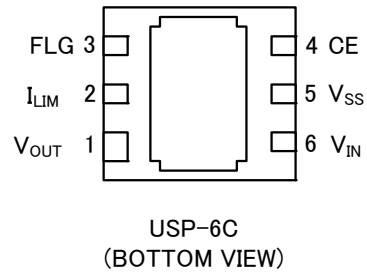

* The dissipation pad for the USP-6C packages should be solder-plated for mounting strength and heat dissipation. Please refer to the reference mount pattern and metal masking. The dissipation pad should be connected to the V_{SS} (No. 5) pin.

■ PIN ASSIGNMENT

| PIN NUMBER | PIN NAME | FUNCTIONS |
|------------|-----------|--------------------------|
| USP-6C | | |
| 1 | V_{OUT} | Output |
| 2 | I_{LIM} | Current Limit Adjustment |
| 3 | FLG | Fault Report |
| 4 | CE | ON/OFF Control |
| 5 | V_{SS} | Ground |
| 6 | V_{IN} | Power Input |

■ FUNCTION

| TYPE | PIN NAME | SIGNAL | STATUS |
|------|----------|--------|----------------------|
| A | CE | H | Active |
| | | L | Stand-by |
| | | OPEN | Undefined State (*1) |
| B | | H | Stand-by |
| | | L | Active |
| | | OPEN | Undefined State (*1) |

* Avoid leaving the CE pin open; set to any fixed voltage.

■ ABSOLUTE MAXIMUM RATINGS

Ta=25°C

| PARAMETER | | SYMBOL | RATINGS | UNITS |
|-------------------------------|--------|------------------|----------------------|-------|
| Input Voltage | | V _{IN} | -0.3~+6.0 | V |
| Output Voltage | | V _{OUT} | -0.3~+6.0 | V |
| Output Current | | I _{OUT} | 1.7 | A |
| CE Input Voltage | | V _{CE} | -0.3~+6.0 | V |
| FLG Pin Voltage | | V _{FLG} | -0.3~+6.0 | V |
| FLG Pin Current | | I _{FLG} | 15 | mA |
| I _{LIM} Pin Voltage | | V _{LIM} | -0.3~+6.0 | V |
| I _{LIM} Pin Current | | I _{LIM} | ±1 | mA |
| Power Dissipation | USP-6C | Pd | 120 | mW |
| | | | 1000 ^{(*)2} | |
| Operating Ambient Temperature | | T _{opr} | -40~+105 | °C |
| Storage Temperature | | T _{stg} | -55~+125 | °C |

* All voltages are described based on the V_{SS}.

^{(*)1} Use with I_{OUT} less than Pd/(V_{IN}-V_{OUT}).

^{(*)2} This is a reference data taken by using the test board. Please refer to page 24 for details.

ELECTRICAL CHARACTERISTICS

Ta=25°C

| PARAMETER | SYMBOL | CONDITIONS | MIN. | TYP. | MAX. | UNITS | CIRCUIT |
|--|--------------------|---|-------|-------|-------|-------|---------|
| Input Voltage | V _{IN} | - | 2.5 | - | 5.5 | V | ① |
| On Resistance | R _{ON} | V _{IN} =3.3V, I _{OUT} =1.0A | - | 100 | 110 | mΩ | ① |
| | | V _{IN} =5.0V, I _{OUT} =1.0A | - | 85 | 104 | mΩ | |
| Supply Current | I _{SS} | V _{OUT} =OPEN | - | 40 | 75 | μA | ② |
| Stand-by Current | I _{STBY} | V _{IN} =5.5V, V _{OUT} =OPEN V _{CE} =V _{SS} (XC8109A series) V _{CE} =V _{IN} (XC8109B series) | - | 0.01 | 1.0 | μA | ② |
| Switch Leakage Current | I _{LEAK} | V _{IN} =5.5V, V _{OUT} =0V V _{CE} =V _{SS} (XC8109A series) V _{CE} =V _{IN} (XC8109B series) | - | 0.01 | 1.0 | μA | ② |
| Current Limit | I _{LIMIT} | V _{OUT} =V _{IN} -0.3V I _{LIMIT} shorted to V _{SS} | 1.170 | 1.300 | 1.430 | A | ① |
| | | V _{OUT} =V _{IN} -0.3V R _{LIMIT} =18.4kΩ | 0.621 | 0.730 | 0.840 | | |
| Short-Circuit Current | I _{SHORT} | V _{OUT} =0V I _{LIMIT} shorted to V _{SS} | - | 0.650 | - | A | ① |
| | | V _{OUT} =0V R _{LIMIT} =18.4kΩ | - | 0.365 | - | | |
| Current Limit Circuit Response Time ^(*) | t _{CLR} | V _{IN} =5.0V, V _{OUT} : OPEN→0V Measure from V _{OUT} =0V to when current falls below a certain I _{LIMIT} value | - | 2.0 | - | μs | ① |
| CE "H" Level Voltage | V _{CEH} | V _{IN} =5.5V, XC8109A series | 1.5 | - | 5.5 | V | ① |
| | | V _{IN} =5.5V, XC8109B series | - | - | 0.8 | | |
| CE "L" Level Voltage | V _{CEL} | V _{IN} =5.5V, XC8109A series | - | - | 0.8 | V | ① |
| | | V _{IN} =5.5V, XC8109B series | 1.5 | - | 5.5 | | |
| CE "H" Level Current | I _{CEH} | V _{IN} =5.5V, V _{CE} =5.5V | -0.1 | - | 0.1 | μA | ① |
| CE "L" Level Current | I _{CEL} | V _{IN} =5.5V, V _{CE} =0V | -0.1 | - | 0.1 | μA | ① |
| UVLO Detected Voltage | V _{UVLOD} | V _{IN} : 2.2V→1.7V | 1.8 | 1.9 | 2.0 | V | ① |
| UVLO Released Voltage | V _{UVLOR} | V _{IN} : 1.7V→2.2V | 1.9 | 2.0 | 2.1 | V | ① |
| UVLO Hysteresis | V _{UHYS} | - | - | 0.1 | - | V | ① |

NOTE:

Unless otherwise stated, V_{IN}=5.0V, I_{OUT}=1mA, I_{LIMIT}=V_{SS}, V_{CE}=V_{IN} (XC8109A series) or V_{CE}=V_{SS} (XC8109B series)

^(*) Design reference value. This parameter is provided only for reference.

■ ELECTRICAL CHARACTERISTICS (Continued)

Ta=25°C

| PARAMETER | SYMBOL | CONDITIONS | MIN. | TYP. | MAX. | UNITS | CIRCUIT |
|---|--------------------|--|------|------|------|-------|---------|
| turn-on time | t _{ON} | R _{LOAD} =10Ω, V _{CE} =0V→2.2V | - | 0.60 | 1.00 | ms | ① |
| turn-off time | t _{OFF} | R _{LOAD} =10Ω, V _{CE} =2.2V→0V | - | 0.08 | 0.13 | ms | ① |
| FLG output FET On-resistance | R _{FLG} | I _{FLG} =10mA, V _{OUT} =5.5V | - | 15 | 20 | Ω | ③ |
| FLG output FET Leakage Current | I _{FOFF} | V _{IN} =5.5V, V _{FLG} =5.5V, V _{OUT} =OPEN | - | 0.01 | 0.1 | μA | ③ |
| FLG delay time | t _{FD1} | over-current condition | 6.5 | 7.5 | 8.5 | ms | ① |
| | t _{FD2} | reverse-voltage condition | 2.7 | 4.0 | 4.7 | ms | ① |
| Reverse Current | I _{REV} | V _{IN} =0V, V _{OUT} =5.5V V _{CE} =5.0V (XC8109A series) V _{CE} =V _{SS} (XC8109B series) | - | 0.1 | 1.0 | μA | ① |
| Reverse Current Prevention Detect Voltage | V _{REV_D} | V _{IN} : 5.0V→4.7V V _{OUT} =5.0V | - | 140 | - | mV | ① |
| Thermal Shutdown Detect Temperature | T _{TSD} | Junction Temperature | - | 150 | - | °C | ① |
| Thermal Shutdown Release Temperature | T _{TSR} | Junction Temperature | - | 130 | - | °C | ① |
| Thermal Shutdown Hysteresis Width | T _{HYS} | Junction Temperature | - | 20 | - | °C | ① |

NOTE:

Unless otherwise stated, V_{IN}=5.0V, I_{OUT}=1mA, I_{LIM}=V_{SS}, V_{CE}=V_{IN} (XC8109A series) or V_{CE}=V_{SS} (XC8109B series)

■ TIMING CHART

● turn-on time, turn-off time

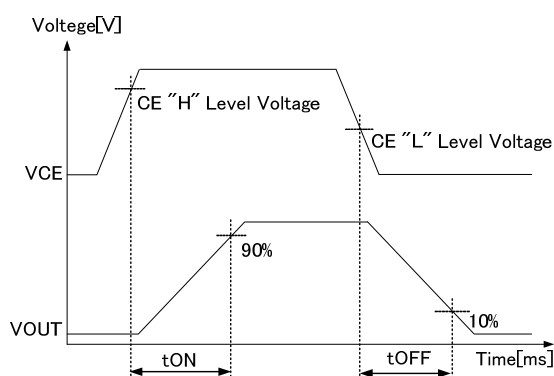

XC8109 Series, Type A

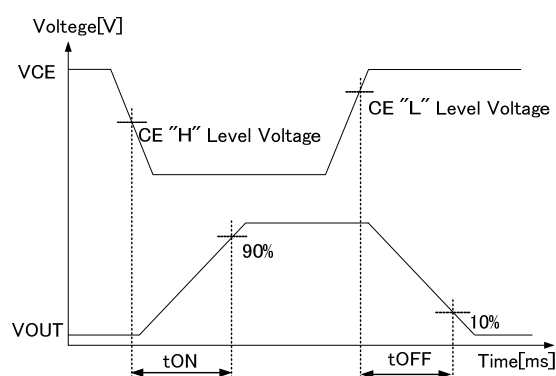

XC8109 Series, Type B

TEST CIRCUITS

$C_{IN}=1.0\mu F$, $C_L=1.0\mu F$

1) CIRCUIT①

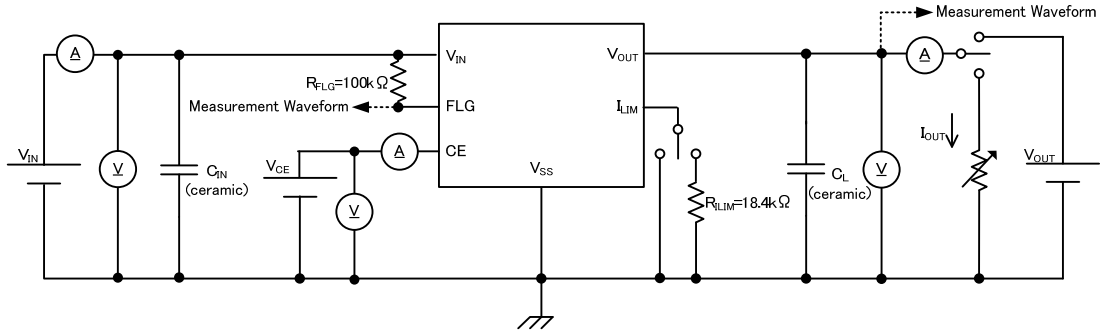

2) CIRCUIT②

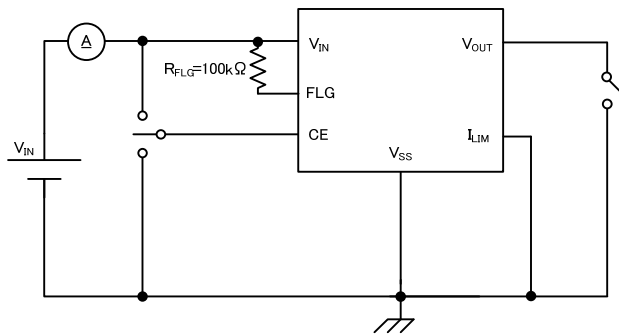

3) CIRCUIT③

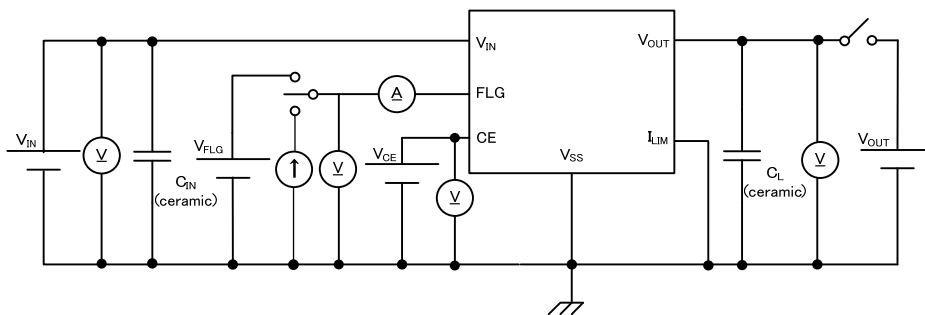

OPERATIONAL EXPLANATION

The XC8109 series is a P-channel MOSFET power switch IC. The XC8109 series consists of a CE circuit, UVLO circuit, thermal shutdown circuit, current limiter circuit, reverse current prevention circuit, control block and others. The gate voltage of the power switch transistor is controlled with control block. The current limiter circuit and reverse current prevention circuit will operate based on the output voltage and output current. (See the BLOCK DIAGRAM below)

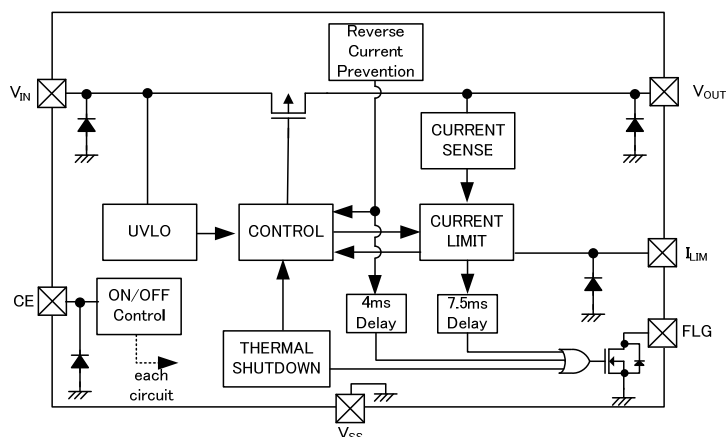

BLOCK DIAGRAM (XC8109 Series)

<CE Pin>

The voltage level which is fed to CE pin controls the status of this IC. If either “H” level or “L” level which is defined as the electrical specification is fed to CE pin, then XC8109 can operate in standard manner. However, if the middle voltage which is neither “H” level nor “L” level is fed to CE pin, the consumption current will increase due to the shoot-through current at internal circuits. Also if CE pin is open, the status of XC8109 cannot be fixed and the behavior will be unstable.

<Thermal Shutdown>

For protection against heat damage of the ICs, thermal shutdown function is built in. When the internal junction temperature reaches the temperature limit, the thermal shutdown circuit operates and the power switch transistor will turn OFF. The IC resumes its operation when the thermal shutdown function is released and the IC’s operation is automatically restored because the junction temperature drops to the level of the thermal shutdown release temperature. When the thermal shutdown circuit detects higher junction temperature than the detect temperature, the voltage level of FLG pin is low level. When the thermal shutdown circuit detects lower junction temperature than the release temperature, the thermal shutdown function is released and the voltage level of FLG pin is high level.

<Under Voltage Lockout (UVLO) >

When the V_{IN} pin voltage goes down to lower voltage than UVLO detected voltage, the power switch transistor turns OFF by UVLO function in order to prevent false output caused by unstable operation of the internal circuitry. When the V_{IN} pin voltage goes up to higher voltage than UVLO released voltage, the UVLO function is released and the power switch transistor can turn ON.

<Soft-start Function>

The soft-start circuit can reduce the in-rush current charged on the output capacitor when IC starts up. Additionally, due to the reduction of the in-rush current, the circuit can reduce the fluctuation of the input voltage as well. The soft-start time is optimized internally and defined as turn-on time. (TYP: 0.6ms)

OPERATIONAL EXPLANATION (Continued)

<Current limiter, short-circuit protection>

When the output current reaches the current limit value, the constant current limit circuit activates and as a result, the output voltage goes down.

If the short circuit comes at the V_{OUT} pin, the output current is limited to the current which is specified as the short-circuit current value. In over-current states, after output voltage drops and the situation is kept for 7.5ms (TYP.), the FLG pin changes to Low level output.

Two types are available for the current limiter circuit: an auto recovery type (product type C) and a latch off type (product type D). After the current limiter circuit activates and the FLG pin outputs low level, the operation is different between these two types.

The auto recovery type continuously limits the output current by the current limit value. In over-current states, after output voltage returns to normal and the situation is kept for 7.5ms (TYP.), the voltage of FLG pin goes up "H" level again.

The latch off type turns off the power switch transistor after the FLG pin outputs Low level. The off state is maintained regardless of whether the over-current state is released.

Latch operation is released by turning off the IC with the CE pin signal and then restarting, or by lowering the input voltage below the UVLO detected voltage once and after that raising it higher than UVLO released voltage.

<Current limit external adjustment function>

By connecting a resistor to the current limit external adjustment pin (I_{LIM} pin), the current limit can be set to any value. By the following equations, the current limit value can be set to any value within a range of 75mA to 1300mA. When the I_{LIM} pin is open, the switch transistor is forcibly turned off.

(In the case of $I_{LIMIT(T)} \geq 500\text{mA}$.)

$$\text{equation 1. } R_{LIM}(\text{k}\Omega) = 32164 / I_{LIMIT(T)}(\text{mA}) - 25.71(\text{k}\Omega)$$

(In the case of $I_{LIMIT(T)} < 500\text{mA}$.)

$$\text{equation 2. } R_{LIM}(\text{k}\Omega) = 130170 / I_{LIMIT(T)}(\text{mA})^{1.2814}(\text{k}\Omega)$$

R_{LIM} : External resistance value $I_{LIMIT(T)}$: Current limit set value

Table1. Current limit set value

| $I_{LIMIT(T)}$ (mA) | R_{LIM} (k Ω) | E96 External resistance value (k Ω) | Current limit value when use E96 external resistance (mA) ^(*) | | |
|------------------------|-------------------------------|---|---|------|------|
| | | | MIN. | TYP. | MAX. |
| 75 | 515 | 511 | 49 | 75 | 102 |
| 100 | 356 | 357 | 69 | 100 | 131 |
| 200 | 147 | 147 | 156 | 200 | 243 |
| 300 | 87.2 | 86.6 | 241 | 302 | 362 |
| 400 | 60.3 | 60.4 | 314 | 399 | 485 |
| 500 | 38.6 | 38.3 | 427 | 503 | 578 |
| 600 | 27.9 | 28.0 | 509 | 599 | 689 |
| 700 | 20.2 | 20.0 | 598 | 704 | 809 |
| 800 | 14.5 | 14.7 | 716 | 796 | 876 |
| 900 | 10.0 | 10.0 | 811 | 901 | 991 |
| 1000 | 6.46 | 6.49 | 899 | 999 | 1099 |
| 1100 | 3.53 | 3.57 | 989 | 1099 | 1208 |
| 1200 | 1.09 | 1.10 | 1080 | 1200 | 1320 |
| 1300 | I_{LIM} shorted to V_{SS} | | 1170 | 1300 | 1430 |

^(*) MIN. value and MAX. value are reference values.

■ OPERATIONAL EXPLANATION (Continued)

<Current limit external adjustment function> (Continued)

Fig1. Current limit set value

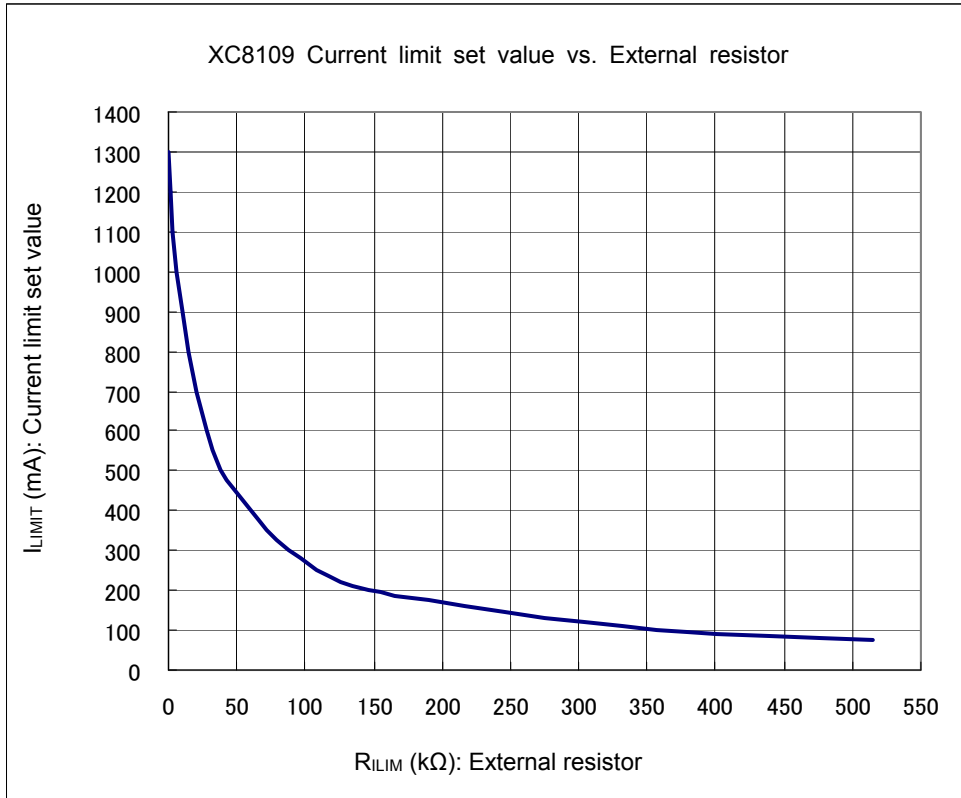

OPERATIONAL EXPLANATION (Continued)

<Current limit external adjustment function> (Continued)

The TYP value of dropout Voltage which is the voltage difference between V_{IN} and V_{OUT} is defined by the equation 3 using output current (I_{OUT}).

$$\text{equation 3. } V_{dif}(mV) = I_{OUT}(mA) \times 0.085(\Omega)$$

The maximum value of dropout voltage has the influence of the setting of a current limit circuit. (Refer to Table 2)

【Example】 In the case of $I_{LIMIT(T)}=500mA$, When output current is 200mA, dropout voltage MAX. value is 22mV.

Table2. Dropout voltage MAX. value (*) unit: (mV)

| Output Current: I_{OUT} | Dropout voltage MAX. value | | | | | | |
|------------------------------|---|-------|-------|-------|-------|-------|-------|
| | Current limit set value: $I_{LIMIT(T)}$ | | | | | | |
| | 75mA | 100mA | 200mA | 300mA | 400mA | 500mA | 600mA |
| 10mA | 4 | 3 | 1 | 1 | 1 | 1 | 1 |
| 30mA | 15 | 10 | 5 | 4 | 3 | 3 | 3 |
| 50mA | 41 | 24 | 9 | 6 | 5 | 5 | 5 |
| 70mA | - | 49 | 14 | 10 | 8 | 7 | 7 |
| 100mA | - | - | 28 | 15 | 12 | 10 | 10 |
| 150mA | - | - | 71 | 29 | 20 | 15 | 15 |
| 200mA | - | - | - | 55 | 33 | 22 | 20 |
| 250mA | - | - | - | 112 | 58 | 32 | 26 |
| 300mA | - | - | - | - | 100 | 46 | 35 |
| 400mA | - | - | - | - | - | 105 | 67 |
| 500mA | - | - | - | - | - | - | 143 |

unit: (mV)

| Output Current: I_{OUT} | Dropout voltage MAX. value | | | | | | |
|------------------------------|---|-------|-------|--------|--------|--------|--------|
| | Current limit set value: $I_{LIMIT(T)}$ | | | | | | |
| | 700mA | 800mA | 900mA | 1000mA | 1100mA | 1200mA | 1300mA |
| 10mA | 1 | 1 | 1 | 1 | 1 | 1 | 1 |
| 30mA | 3 | 3 | 3 | 3 | 3 | 3 | 3 |
| 50mA | 5 | 5 | 5 | 5 | 5 | 5 | 5 |
| 70mA | 7 | 7 | 7 | 7 | 7 | 7 | 7 |
| 100mA | 10 | 10 | 10 | 10 | 10 | 10 | 10 |
| 150mA | 15 | 15 | 15 | 15 | 15 | 15 | 15 |
| 200mA | 20 | 20 | 20 | 20 | 20 | 20 | 20 |
| 250mA | 26 | 26 | 26 | 26 | 26 | 26 | 26 |
| 300mA | 30 | 30 | 30 | 30 | 30 | 30 | 30 |
| 400mA | 48 | 41 | 41 | 41 | 41 | 41 | 41 |
| 500mA | 85 | 60 | 51 | 51 | 51 | 51 | 51 |
| 600mA | 167 | 100 | 75 | 61 | 61 | 61 | 61 |
| 700mA | - | 183 | 122 | 85 | 71 | 71 | 71 |
| 800mA | - | - | 214 | 132 | 97 | 82 | 81 |
| 900mA | - | - | - | 223 | 144 | 107 | 92 |

(*) MAX. value is reference value.

■ OPERATIONAL EXPLANATION (Continued)

<Reverse current prevention>

An internal circuit is built in that prevents reverse current from the V_{OUT} pin to the V_{IN} pin.

When the difference between input voltage and V_{OUT} pin voltage is higher than the detect voltage set internally, the reverse current prevention circuit activates, and the power switch transistor turns off, then the reverse current from the V_{OUT} pin to the V_{IN} pin is reduced to 0.1 μ A (TYP.).

If the reverse-voltage state lasts for 4ms (TYP.), the FLG pin changes to Low level output.

Two types are available for the reverse current prevention circuit: the auto recovery type (product type C) and the latch off type (product type D). After the reverse current prevention circuit activates and the FLG pin outputs low level, the operation is different between these two types.

On the auto recovery type, when the output voltage drops below the input voltage, the reverse current prevention circuit stops immediately, and the power switch transistor turns on again. If the output voltage remains lower than the input voltage for 4ms (TYP.), the FLG pin returns to High level output.

On the latch off type, the power switch transistor remains in the off state even if the reverse voltage state is released.

<Flag function>

The flag circuit is built in which monitors the state of the power switch.

The FLG pin outputs Low level when the reverse current prevention function is operating. A resistance of 10k Ω to 100k Ω is recommended for the FLG pin pull-up resistance.

Auto recovery type (product type C)

| Protective function | FLG pin Low level output | Return to FLG pin High level output |
|----------------------------|--|--|
| Current limiter | In over-current states, after output voltage drops and the situation is kept for 7.5ms (TYP.). | In over-current states, after output voltage returns to normal and the situation is kept for 7.5ms (TYP.). |
| Reverse current prevention | 4.0ms after reverse voltage detection | 4.0ms after reverse voltage release |
| Thermal shutdown | Same time as overheat state is detected | Same time as overheat state is released |

Latch off type (product type D)

| Protective function | FLG pin Low level output | Return to FLG pin High level output |
|----------------------------|--|---|
| Current limiter | In over-current states, after output voltage drops and the situation is kept for 7.5ms (TYP.). | When latch operation is released |
| Reverse current prevention | 4.0ms after reverse voltage detection | When latch operation is released |
| Thermal shutdown | Same time as overheat state is detected | Same time as overheat state is released |

■ NOTES ON USE

1. For the phenomenon of temporal and transitional voltage decrease or voltage increase, the IC may be damaged or deteriorated if IC is used beyond the absolute MAX. specifications.
2. Where wiring impedance is high, operations may become unstable due to noise depending on output current.
Please keep the resistance low between V_{IN} and V_{SS} wiring in particular.
3. Please place the input capacitor (C_{IN}) and the output capacitor (C_L) as close to the IC as possible.
For the input or output capacitor, a capacitance of 1.0 μ F or higher is recommended.
4. When the voltage which is higher than the maximum input voltage is fed to the V_{IN} pin, and V_{OUT} is shorted to the V_{SS} level, in this case the short circuit may cause a fatal impact to operation for the IC. Please use within the operational voltage range.
5. The current limit value can be adjusted by external resistor (R_{LIM}). The characteristic of the resistor influence the current limit value, please choose the resistor with small tolerance and temperature coefficient.
6. 80% of current limit set value is the recommended value of maximum output current.
7. Torex places an importance on improving our products and its reliability.
However, by any possibility, we would request user fail-safe design and post-aging treatment on system or equipment.

■ TYPICAL PERFORMANCE CHARACTERISTICS

(1) UVLO detect voltage vs. Input voltage

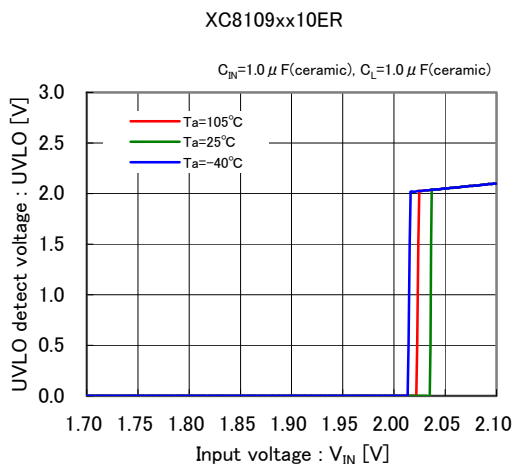

(2) UVLO release voltage vs. Input voltage

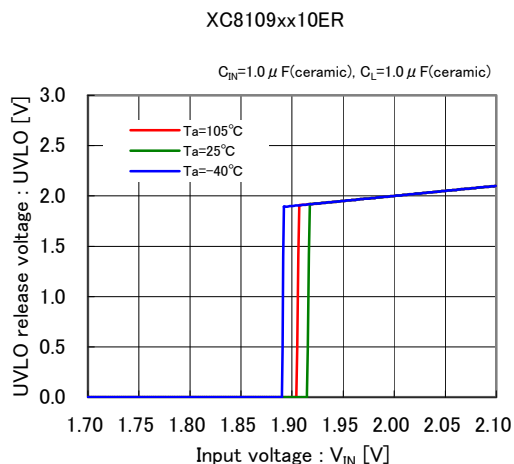

(3) UVLO threshold voltage vs. Ambient temperature

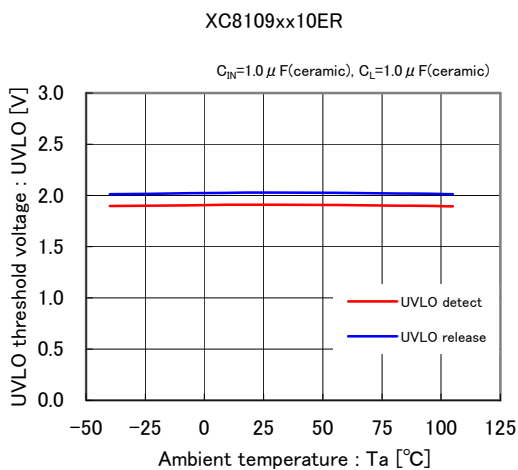

(4) Stand-by current vs. Input voltage

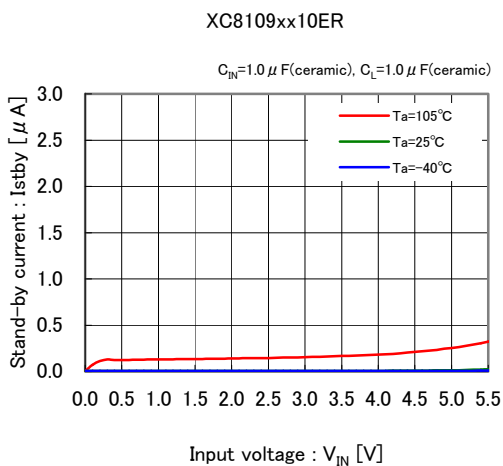

(5) Stand-by current vs. Ambient temperature

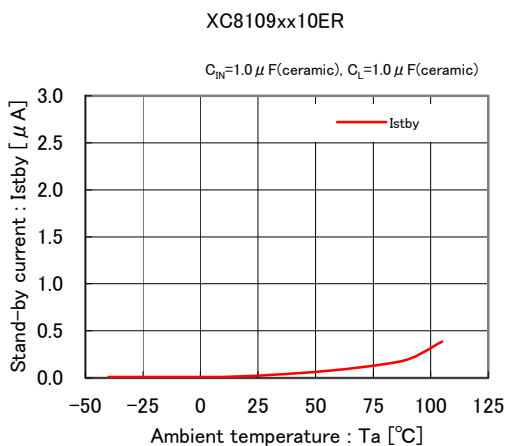

TYPICAL PERFORMANCE CHARACTERISTICS (Continued)

(6) Supply current vs. Input voltage (sweep up)

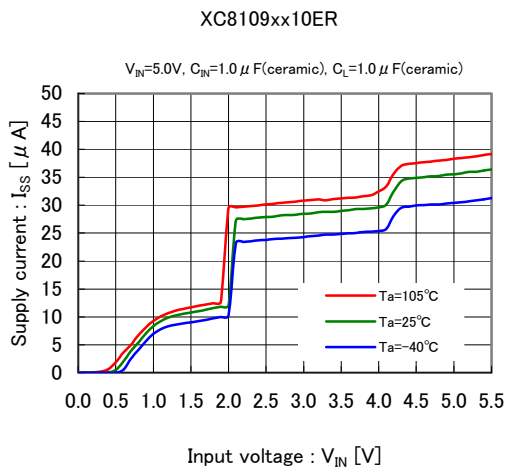

(7) Supply current vs. Ambient temperature

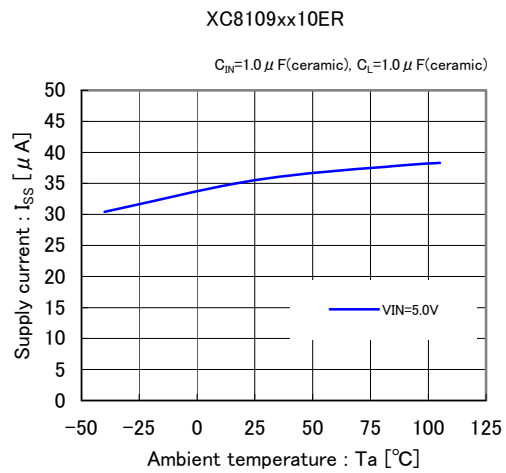

(8) CE "H" level voltage vs. Input voltage

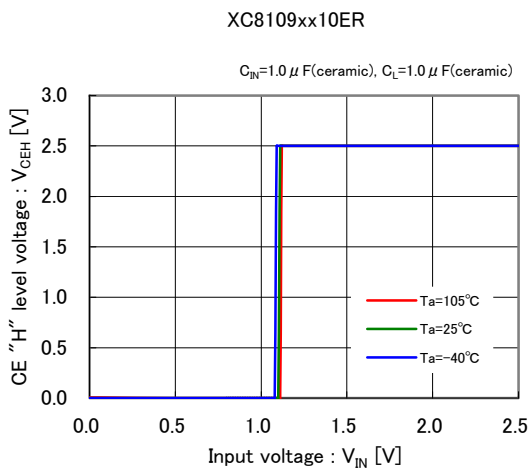

(9) CE "L" level voltage vs. Input voltage

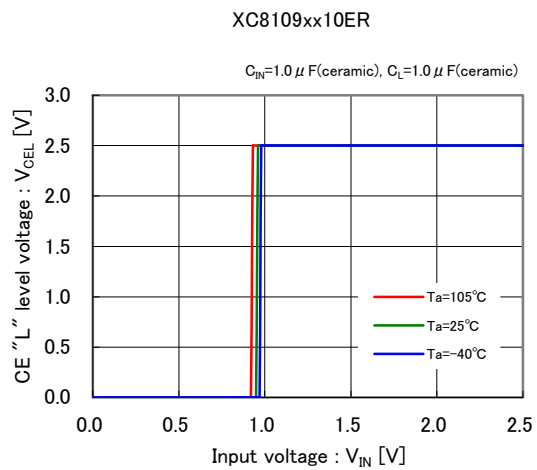

(10) CE threshold voltage vs. Ambient temperature

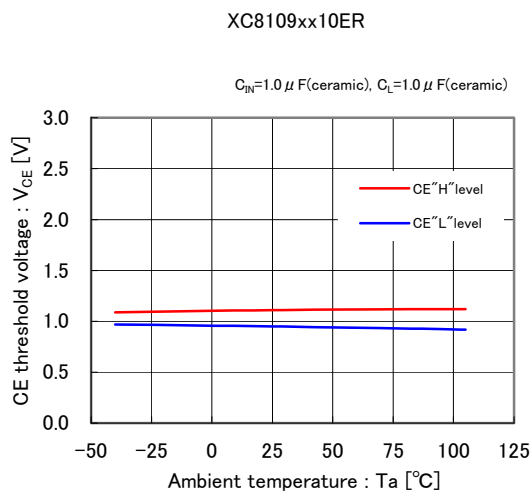

■ TYPICAL PERFORMANCE CHARACTERISTICS (Continued)

(11) On resistance vs. Input voltage

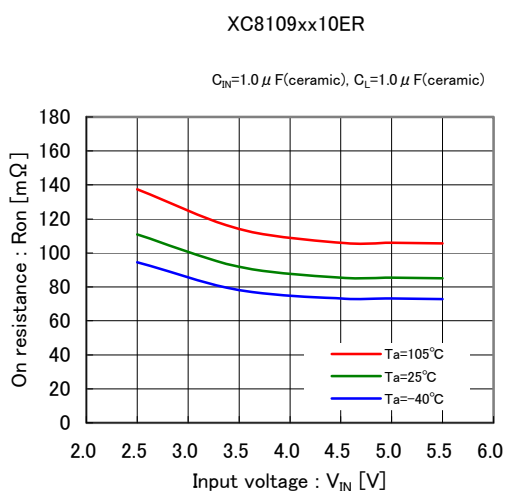

(12) On resistance vs. Ambient temperature

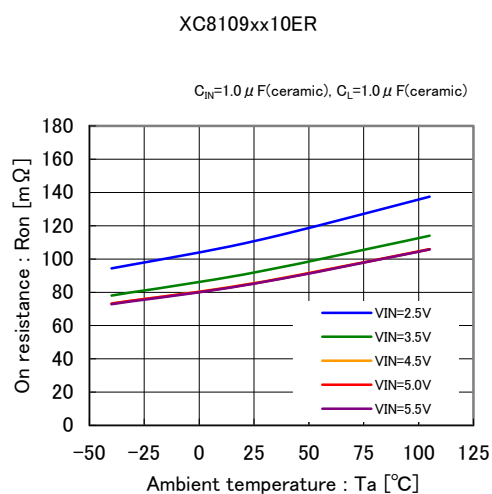

(13) Turn-on time vs. Input voltage

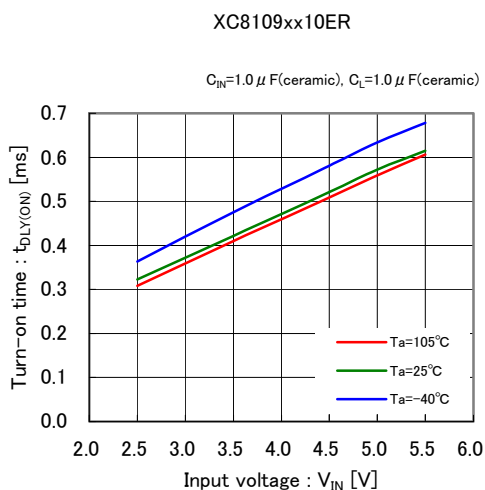

(14) Turn-on time vs. Ambient temperature

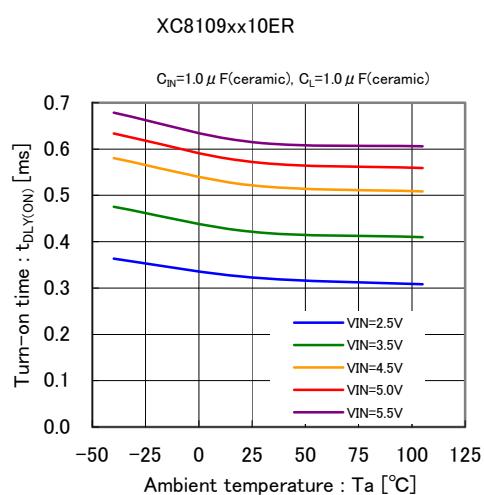

(15) Turn-off time vs. Input voltage

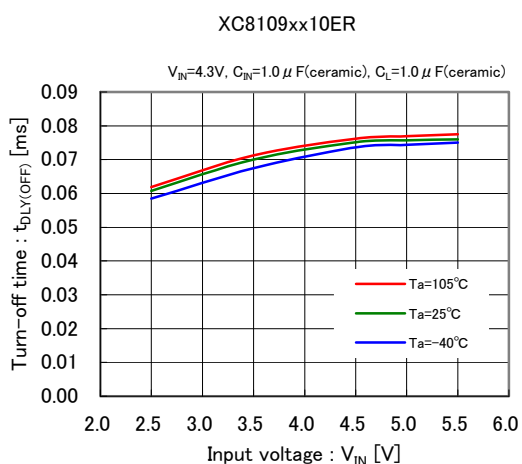

(16) Turn-off time vs. Ambient temperature

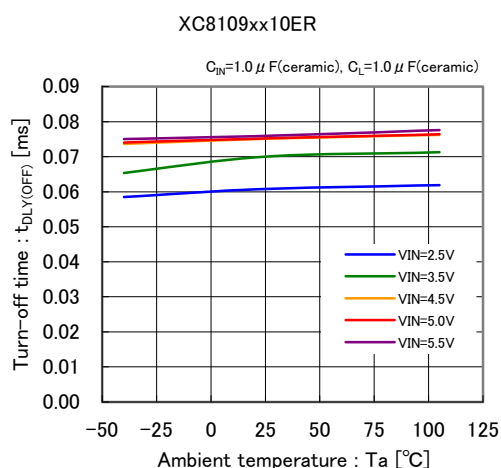

TYPICAL PERFORMANCE CHARACTERISTICS (Continued)

(17) FLG delay time over-current vs. Ambient temperature

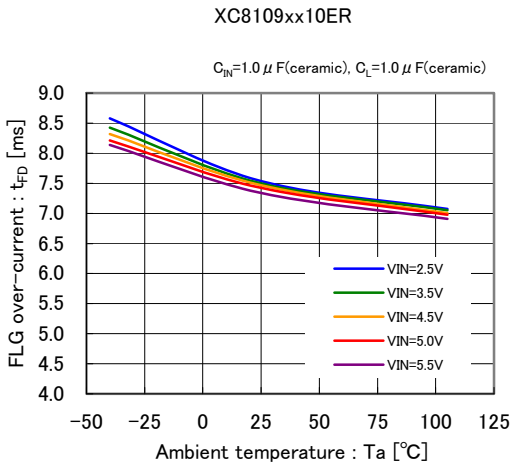

(18) FLG delay time reverse-voltage vs. Ambient temperature

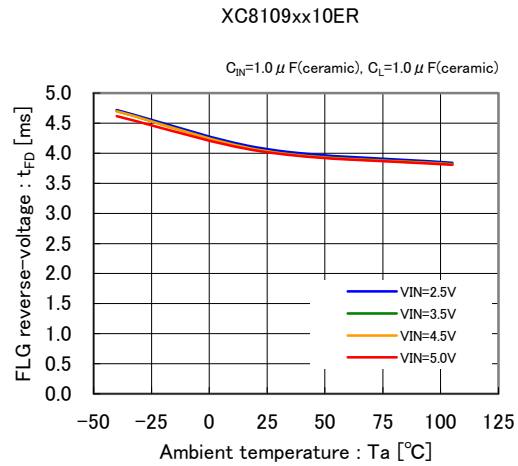

(19) Output voltage vs. Output current

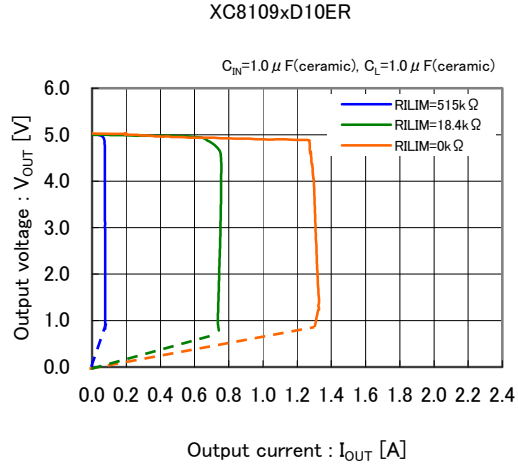
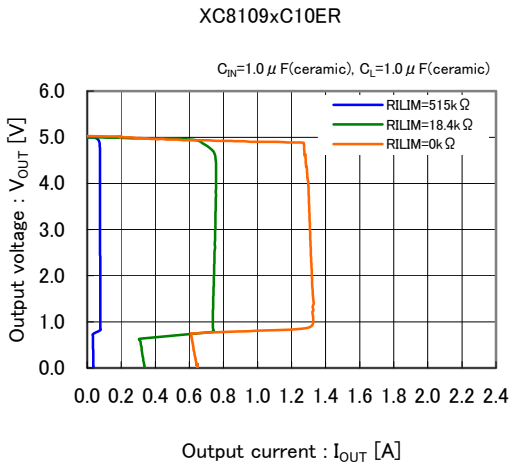

In over-current states, after output voltage drops and the lapse of 7.5ms, the latch off type turns off the power switch transistor.

(20) Turn-on delay vs. Rise time ($C_L=1.0\ \mu\text{F}$)

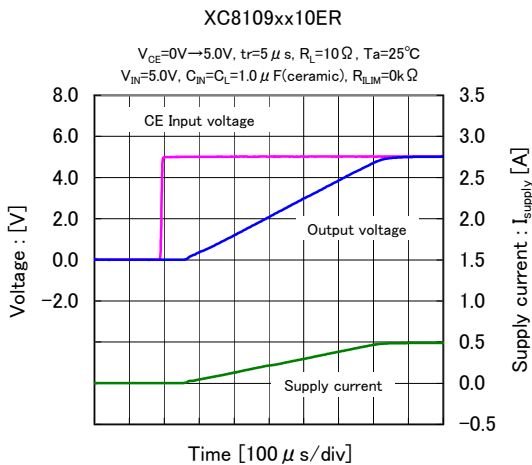

(21) Turn-off delay vs. Fall time ($C_L=1.0\ \mu\text{F}$)

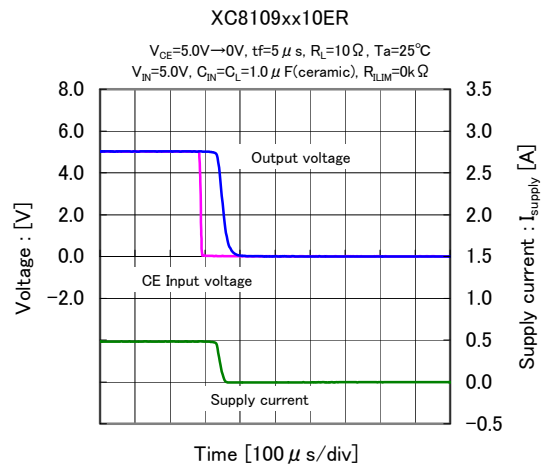

■ TYPICAL PERFORMANCE CHARACTERISTICS (Continued)

(22) Turn-on delay vs. Rise time ($C_L=120\ \mu\text{F}$)

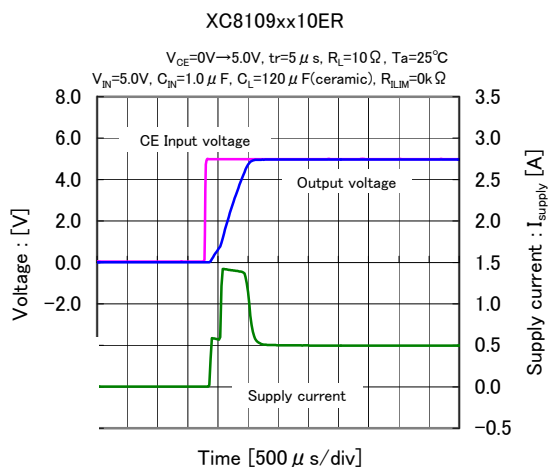

(23) Turn-off delay vs. Fall time ($C_L=120\ \mu\text{F}$)

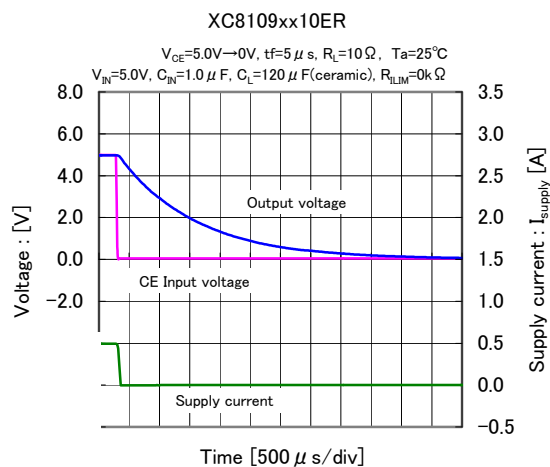

(24) Short circuit current, Device enabled into short

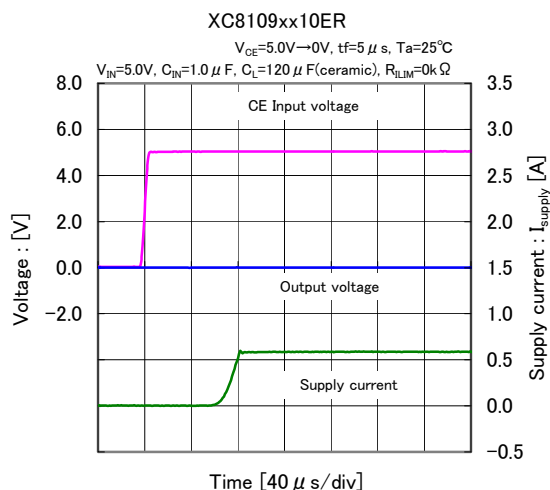
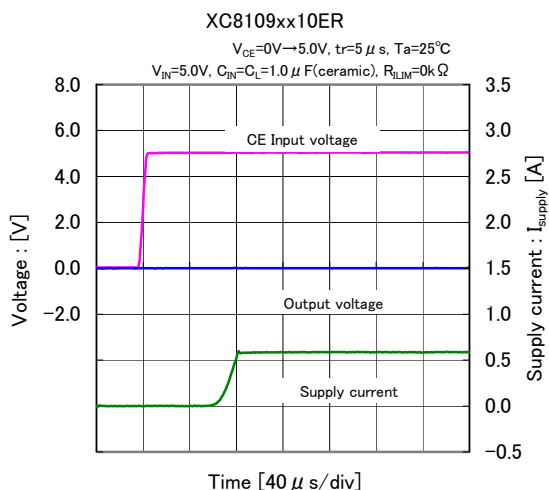

(25) Short-circuit transient response
($V_{OUT}=5.0\ \Omega \rightarrow \text{short}$, $C_L=1.0\ \mu\text{F}$)

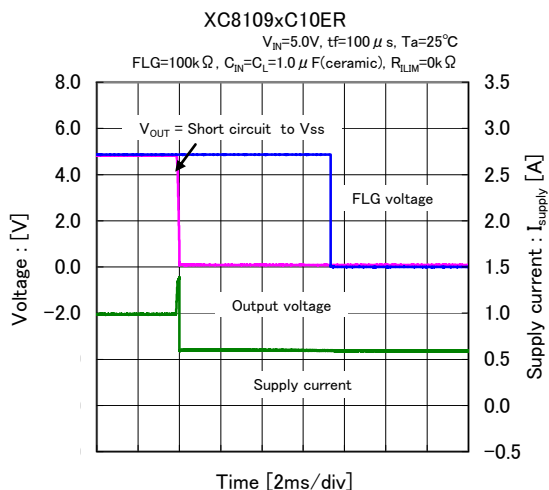

(26) Short-circuit transient response
($V_{OUT}=\text{short} \rightarrow 5.0\ \Omega$, $C_L=1.0\ \mu\text{F}$)

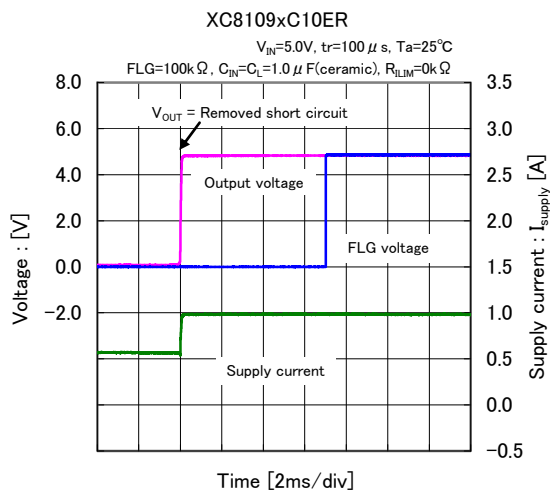

TYPICAL PERFORMANCE CHARACTERISTICS (Continued)

(27) Short-circuit transient response
(V_{OUT} =open→short, $C_L=1.0\mu F$)

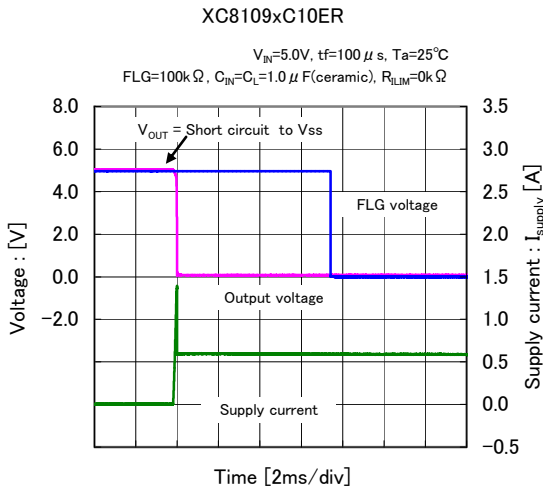

(28) Short-circuit transient response
(V_{OUT} =short→open, $C_L=1.0\mu F$)

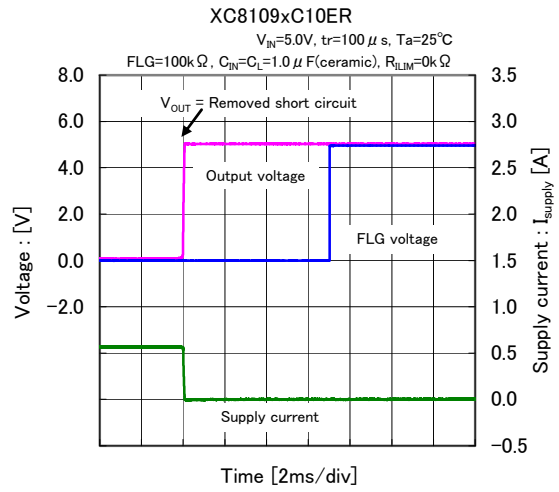

(29) Short-circuit transient response
($V_{OUT}=5.0\Omega$ →short, $C_L=120\mu F$)

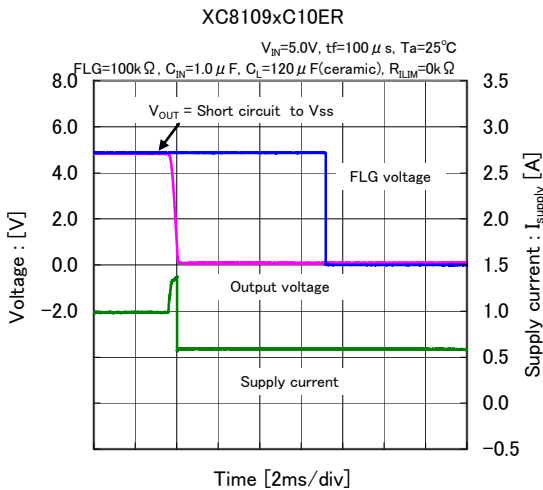

(30) Short-circuit transient response
(V_{OUT} =short→5.0 Ω , $C_L=120\mu F$)

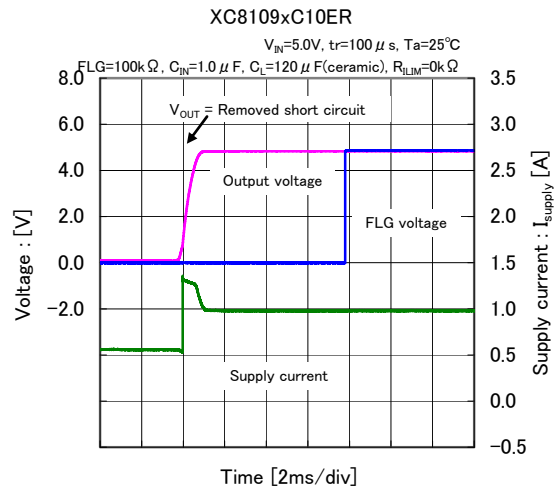

(31) Short-circuit transient response
(V_{OUT} =open→short, $C_L=120\mu F$)

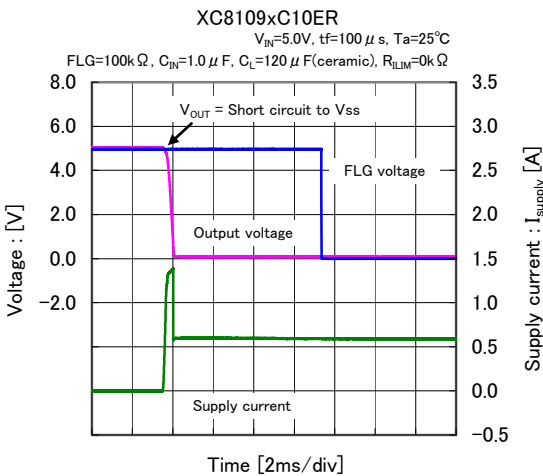

(32) Short-circuit transient response
(V_{OUT} =short→open, $C_L=120\mu F$)

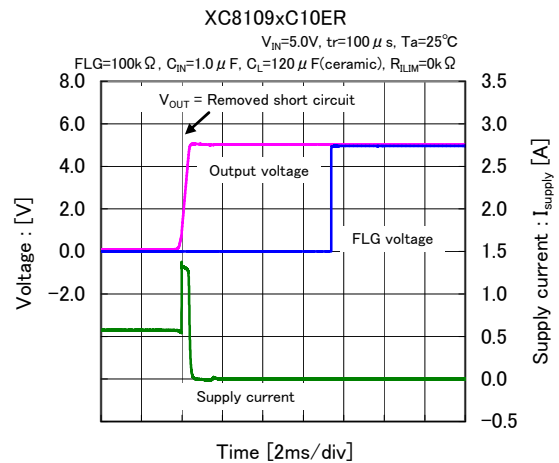

■ TYPICAL PERFORMANCE CHARACTERISTICS (Continued)

(33) UVLO transient response ($C_L=1.0\ \mu\text{F}$)

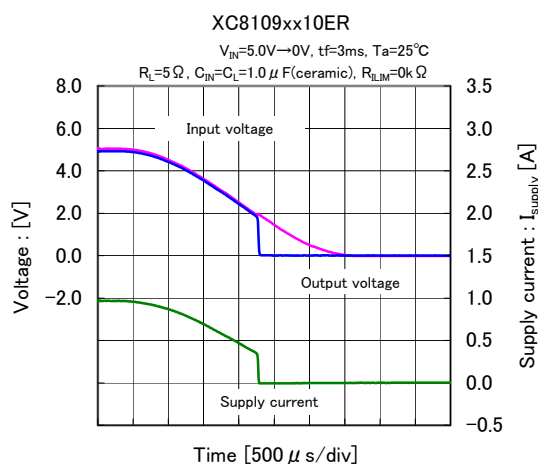
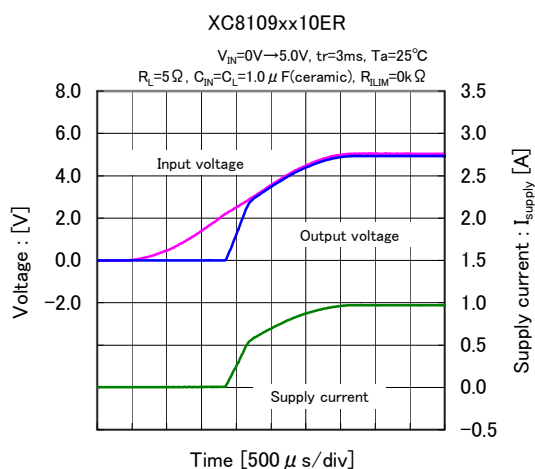

(34) UVLO transient response ($C_L=120\ \mu\text{F}$)

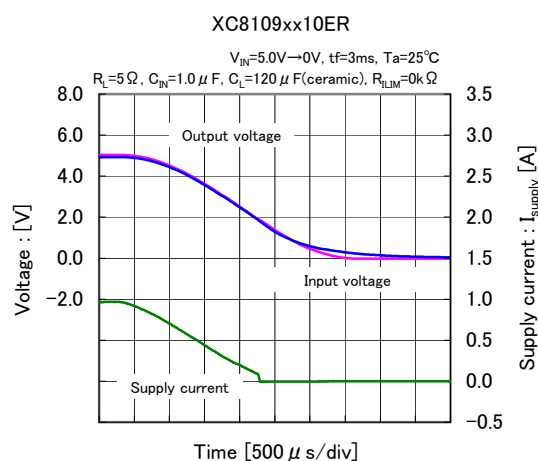
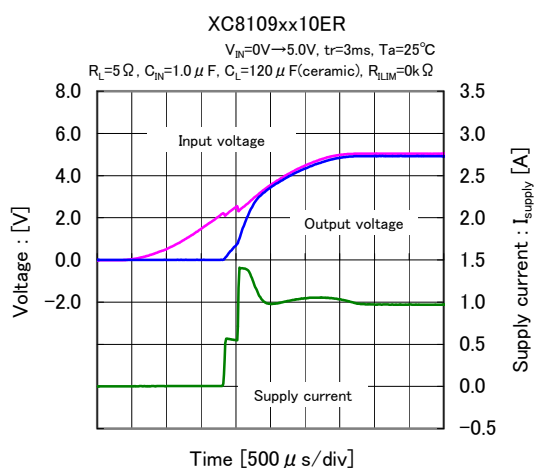

(35) Reverse voltage detected voltage ($C_L=1.0\ \mu\text{F}$)

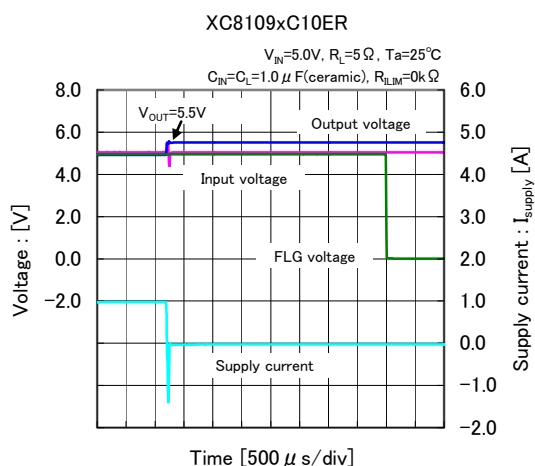

(36) Reverse voltage released voltage ($C_L=1.0\ \mu\text{F}$)

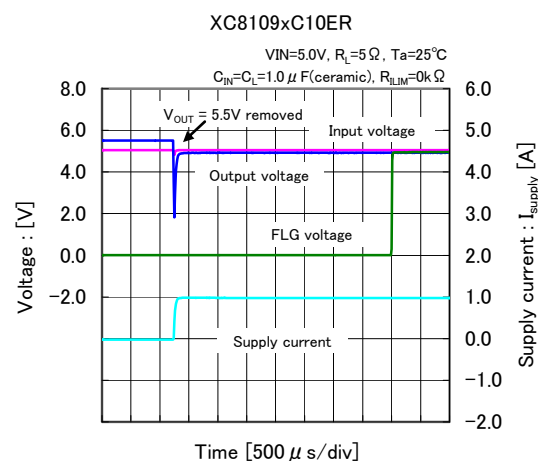

TYPICAL PERFORMANCE CHARACTERISTICS (Continued)

(37) Reverse voltage detected voltage ($C_L=120\ \mu\text{F}$)

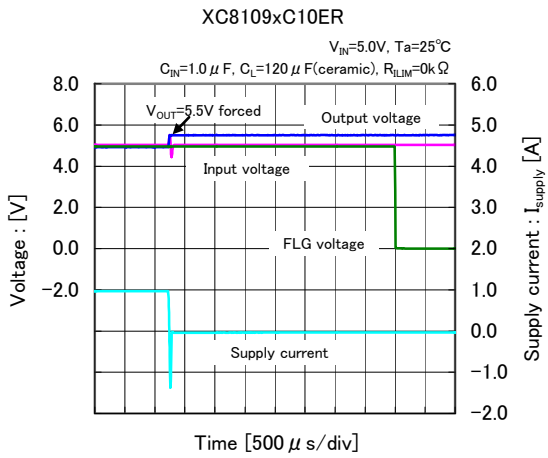

(38) Reverse voltage released voltage ($C_L=120\ \mu\text{F}$)

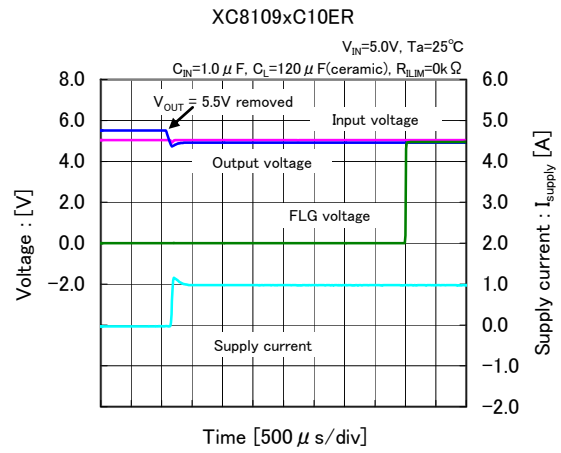

(39) CE transient response

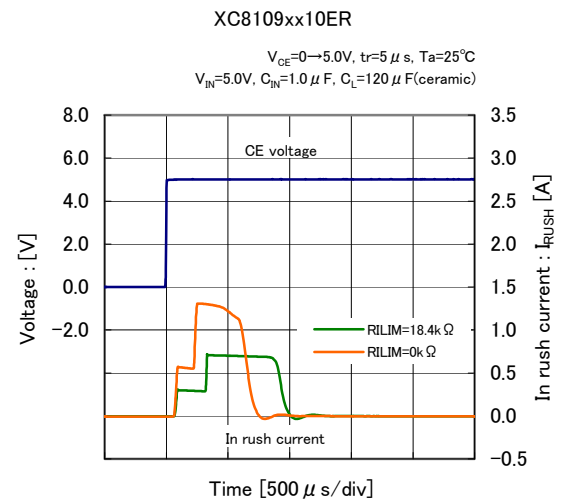
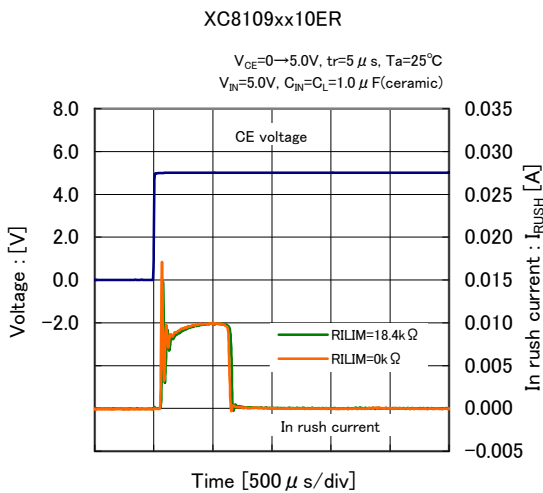

(40) Short applied

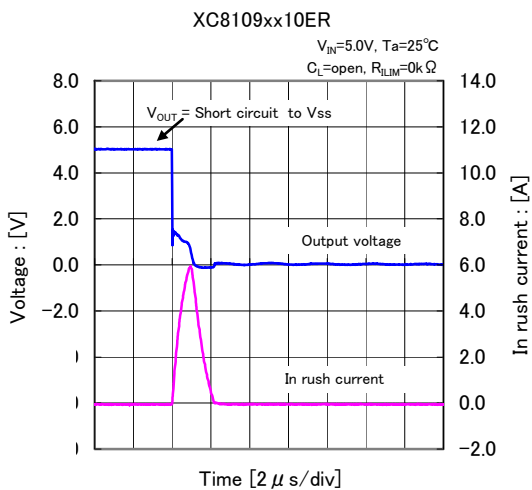

(41) Current limit adapted time

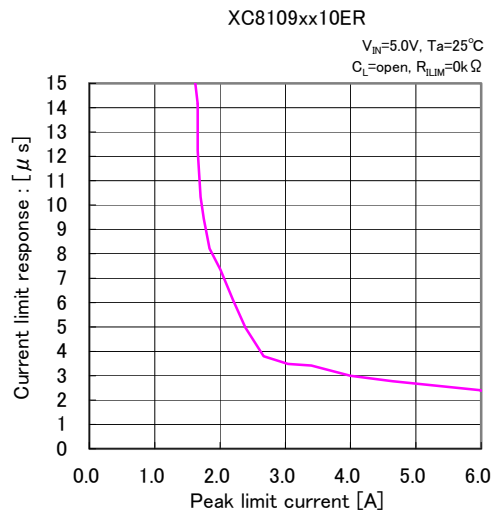

PACKAGING INFORMATION

● USP-6C (unit:mm)

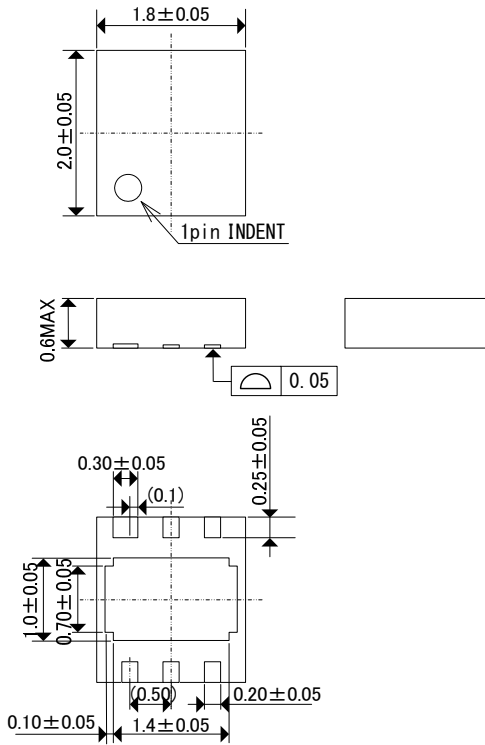

● USP-6C Reference Pattern Layout (unit: mm)

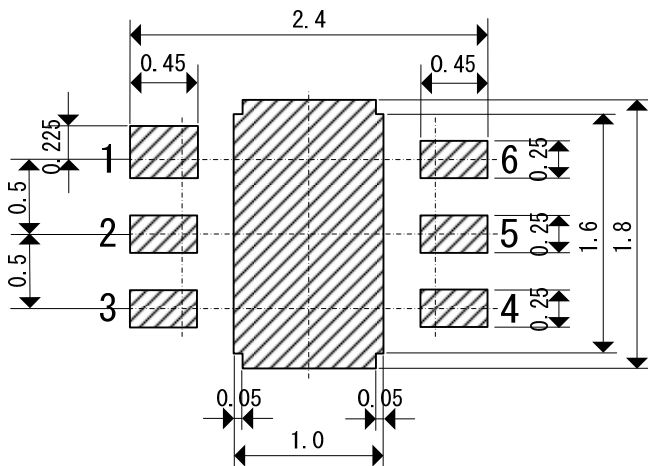

● USP-6C Reference Metal Mask Design (unit: mm)

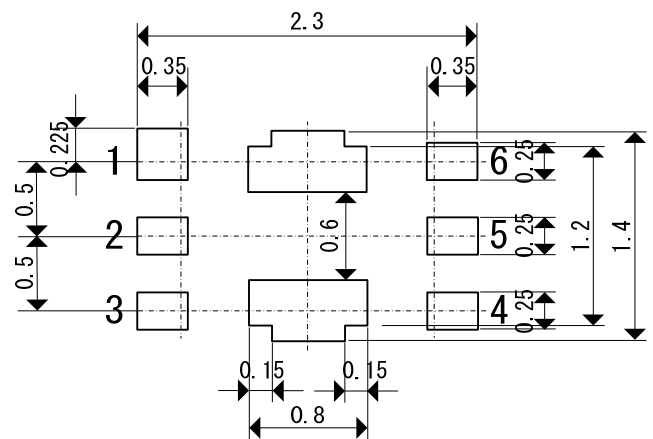

PACKAGING INFORMATION (Continued)

● USP-6C Power Dissipation

Power dissipation data for the USP-6C is shown in this page.
The value of power dissipation varies with the mount board conditions.
Please use this data as the reference data taken in the following condition.

1. Measurement Condition

- Condition: Mount on a board
- Ambient: Natural convection
- Soldering: Lead (Pb) free
- Board: Dimensions 40 x 40 mm (1600 mm² in one side)
Copper (Cu) traces occupy 50% of the board area
In top and back faces
Package heat-sink is tied to the copper traces
- Material: Glass Epoxy (FR-4)
- Thickness: 1.6mm
- Through-hole 4 x 0.8 Diameter

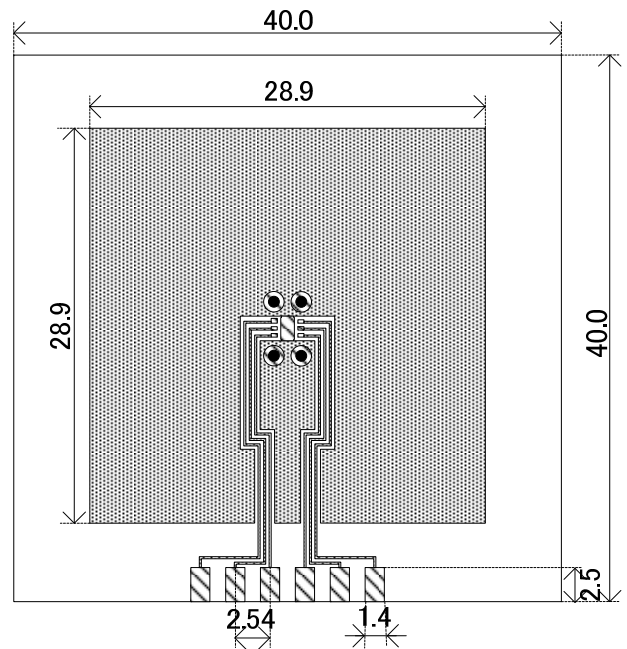

Evaluation Board (Unit: mm)

2. Power Dissipation vs. Ambient Temperature (105°C)

Board Mount ($T_{jmax}=125^{\circ}\text{C}$)

| Ambient Temperature (°C) | Power Dissipation Pd (mW) | Thermal Resistance (°C/W) |
|--------------------------|---------------------------|---------------------------|
| 25 | 1000 | 100.00 |
| 105 | 200 | |

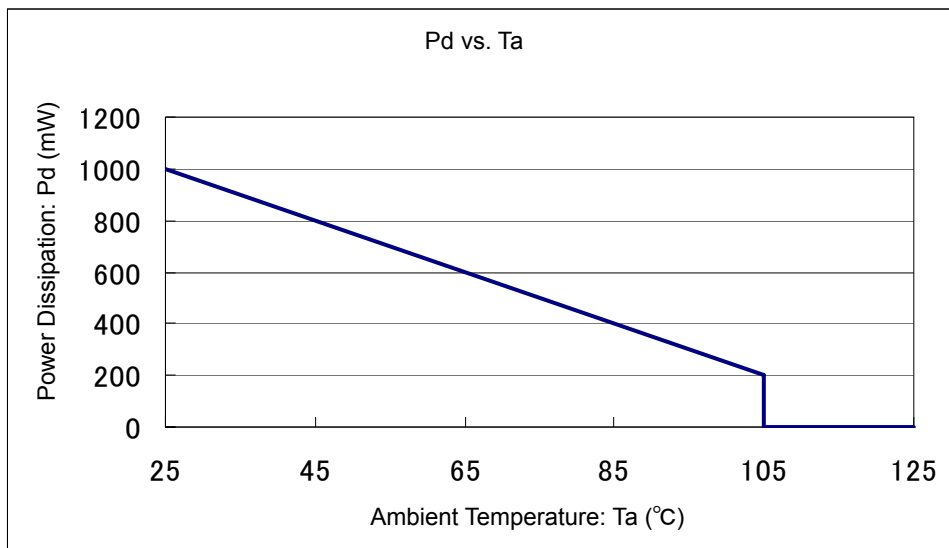

MARKING RULE

USP-6C

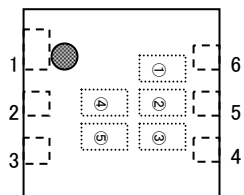

① represents products series

| MARK | PRODUCT SERIES |
|------|----------------|
| Z | XC8109*****-G |

② represents product type

| MARK | CE LOGIC | PROTECTION CIRCUIT TYPE | PRODUCT |
|------|-------------|-------------------------|----------------|
| 1 | Active High | Auto-recovery | XC8109AC****-G |
| 2 | Active High | Latch-off | XC8109AD****-G |
| 3 | Active Low | Auto-recovery | XC8109BC****-G |
| 4 | Active Low | Latch-off | XC8109BD****-G |

③ represents maximum output current

| MARK | CURRENT (A) | PRODUCT SERIES |
|------|-------------|----------------|
| 6 | 0.9 | XC8109**10**-G |

④⑤ represents production lot number

01~09, 0A~0Z, 11~9Z, A1~A9, AA~AZ, B1~ZZ in order.

(G, I, J, O, Q, W excluded)

* No character inversion used.

1. The products and product specifications contained herein are subject to change without notice to improve performance characteristics. Consult us, or our representatives before use, to confirm that the information in this datasheet is up to date.
2. We assume no responsibility for any infringement of patents, patent rights, or other rights arising from the use of any information and circuitry in this datasheet.
3. Please ensure suitable shipping controls (including fail-safe designs and aging protection) are in force for equipment employing products listed in this datasheet.
4. The products in this datasheet are not developed, designed, or approved for use with such equipment whose failure or malfunction can be reasonably expected to directly endanger the life of, or cause significant injury to, the user.
(e.g. Atomic energy; aerospace; transport; combustion and associated safety equipment thereof.)
5. Please use the products listed in this datasheet within the specified ranges.
Should you wish to use the products under conditions exceeding the specifications, please consult us or our representatives.
6. We assume no responsibility for damage or loss due to abnormal use.
7. All rights reserved. No part of this datasheet may be copied or reproduced without the prior permission of TOREX SEMICONDUCTOR LTD.

TOREX SEMICONDUCTOR LTD.