



# MAX4951AE Evaluation Kit

## General Description

The MAX4951AE evaluation kit (EV kit) provides a proven design to evaluate the MAX4951AE dual-channel buffer. The EV kit contains four sections: application circuit, characterization circuit, and two sets of calibration traces.

The application circuit is designed to demonstrate the MAX4951AE IC's use in re-driving Serial-ATA (SATA) signals and SATA cable detection. This section of the EV kit operates from an external +5V supply that is regulated by an on-board LDO to +3.3V, which powers the MAX4951AE (U1) device. All traces in the application circuit are 100Ω differential controlled-impedance traces.

The characterization circuit is provided for eye diagram evaluation using SMA connectors and 50Ω controlled-impedance traces. This section is powered by an external +3.3V power supply.

## Features

- ◆ Application Circuit with SATA Input/Output
- ◆ Eye Diagram Test Circuit with SMA Inputs/Outputs
- ◆ Calibration Traces (50Ω Load Trace and Through Trace)
- ◆ Proven PCB Layout
- ◆ Fully Assembled and Tested

## Ordering Information

PART	TYPE
MAX4951AEEVKIT+	EV Kit

+Denotes lead(Pb)-free and RoHS compliant.

## Component List

DESIGNATION	QTY	DESCRIPTION
C1–C8, C14–C17, C22–C25	16	0.01μF ±10%, 25V X7R ceramic capacitors (0402) Murata GRM155R71E103KA TDK C1005X7R1E103K
C9, C18, C26, C27	4	1μF ±10%, 16V X7R ceramic capacitors (0603) Murata GRM188R71C105K TDK C1608X7R1C105K
C10–C13, C19, C20, C21	7	0.1μF ±10%, 16V X7R ceramic capacitors (0402) Murata GRM155R71C104K TDK C1005X7R1C104K
C28	1	4.7μF ±10%, 10V X7R ceramic capacitor (0805) Murata GRM21BR71A475K
D1	1	Green LED (0603)
H1	1	Disk-drive power connector
J1, J2	2	7-position SATA vertical connectors
JU1, JU2, JU3, JU5, JU7	5	3-pin headers, 0.1in centers

DESIGNATION	QTY	DESCRIPTION
JU4	1	2-pin header, 0.1in centers
JU6	0	Not installed, 3-pin header
JU8, JU9	0	Not installed, 3-pin headers
P1–P10	10	Edge-mount receptacle SMA connectors
R1	1	200Ω ±5% resistor (0603)
R2, R3	2	49.9Ω ±1% resistors (0603)
R4, R6	2	0Ω resistors (0603)
R5	0	Not installed, resistor (0603)
U1, U2	2	SATA/eSATA bidirectional redrivers (20 TQFN-EP*) Maxim MAX4951AECTP+
U3	1	3.3V regulator (6 SOT23) Maxim MAX6329TPUT-T+ (Top Mark: AAIP)
	6	Shunts
	1	PCB: MAX4951AE EVALUATION KIT+

\*EP = Exposed pad.

Evaluates: MAX4951AE

# MAX4951AE Evaluation Kit

## Component Suppliers

SUPPLIER	PHONE	WEBSITE
Murata Electronics North America, Inc.	770-436-1300	www.murata-northamerica.com
TDK Corp.	847-803-6100	www.component.tdk.com

**Note:** Indicate that you are using the MAX4951AE when contacting these component suppliers.

### Quick Start (Application Circuit)

#### Recommended Equipment

- MAX4951AE EV kit
- +5V power supply
- Two SATA cables
- SATA device (e.g., hard drive)
- SATA host (e.g., PC)

#### Procedure

The MAX4951AE EV kit is fully assembled and tested. Follow the steps below to verify board operation:

- 1) Verify that all jumpers are in their default position, as shown in Table 1.
- 2) Connect the first SATA cable from the PC to the host (J1) connector on the EV kit.
- 3) Connect the second SATA cable from the device (J2) connector to the SATA device.
- 4) Verify communication between the host PC and SATA device.

**Table 1. Default Shunt Positions**

JUMPER	SHUNT POSITION
JU1, JU5	1-2
JU2, JU3, JU7	2-3
JU4	Installed

### Detailed Description of Hardware

The MAX4951AE evaluation kit (EV kit) evaluates the MAX4951AE dual-channel buffer. The MAX4951AE is designed to redrive Serial-ATA (SATA) and external Serial-ATA (eSATA) signals. The EV kit is divided into four sections: application circuit, characterization circuit, and two sets of calibration traces.

The application circuit utilizes 100Ω differential controlled-impedance traces and provides two SATA connectors (J1 and J2), allowing for evaluation of the MAX4951AE in a SATA environment. The characterization circuit utilizes 50Ω controlled-impedance traces and SMA input/output connectors, allowing for eye diagrams and input/output return-loss measurements.

The lower half of the MAX4951AE EV kit provides two sets of calibration traces, all of which are matched to the trace lengths in the characterization circuit. These traces provide a reference for determining the performance of only the MAX4951AE device when evaluated in the characterization circuit.

The MAX4951AE has a cable-detect feature ( $\overline{\text{CAD}}$ ) that reduces power consumption to < 1mA when a drive is not connected, and permits normal functionality, when a cable and drive are connected to J2.

#### Application Circuit (U1)

The application circuit provides the means for evaluating the MAX4951AE in a SATA application. This section of the EV kit provides two SATA connectors (J1 and J2), one for connection to a SATA host (e.g., PC) and the other for connection to a SATA device (e.g., hard drive).

# MAX4951AE Evaluation Kit

Evaluates: MAX4951AE

## Input Supply (VIN)

The MAX4951AE must be powered by +3.3V. There are two ways to get this voltage, through the on-board LDO (U3) or by connecting directly to a +3.3V power supply. When using the on-board voltage regulator, the LDO can be powered by the 4-pin Molex connector (H1), or by a +5V external supply connected to the VIN and GND pads. When using the on-board LDO to supply power, there is a power LED (D1) to indicate the presence of +3.3V at VCC.

The user can also connect directly to a +3.3V supply, which is available on a SATA power connector. The shunt should be removed from jumper JU4 and the +3.3V supply or SATA power can be connected to the +3.3V pad (see Table 2).

**Table 2. Jumper JU4 Function**

SHUNT POSITION	VCC PIN (U1)	DESCRIPTION
Installed*	Connected to on-board LDO output	U1 powered by LDO output, +3.3V
Not installed	Connected to external supply	Powered by +3.3V from an external supply or SATA power connector

\*Default position.

**Table 3. Jumper JU1 Function**

SHUNT POSITION	EN PIN (U1)	DESCRIPTION
1-2*	Connected to +3.3V	Buffers enabled for normal operation
2-3	Connected to GND	Buffers disabled and device is in low-power mode

\*Default position.

## Device Enable (JU1)

The MAX4951AE (U1) is enabled/disabled by configuring jumper JU1 (see Table 3). When disabled, the MAX4951AE buffers are powered down and the part is placed in a low-power mode. When enabled, and no SATA device is plugged in ( $\overline{\text{CAD}}$  is unconnected), the device enters a low-power mode. Once a SATA device is plugged in ( $\overline{\text{CAD}}$  grounded), the device goes into active mode.

## Output Boost Control (JU2, JU3)

The MAX4951AE host and device can be evaluated with standard SATA output levels or with boosted output levels. Configure jumper JU2 to enable/disable the host output boost and jumper JU3 to enable/disable the device output boost (see Tables 4 and 5).

**Table 4. Jumper JU2 Function**

SHUNT POSITION	BB PIN (U1)	DESCRIPTION
1-2	Connected to +3.3V	Host output boost enabled
2-3*	Connected to GND	Host output boost disabled (standard SATA output levels)
Not installed	Not connected	

\*Default position.

**Table 5. Jumper JU3 Function**

SHUNT POSITION	BA PIN (U1)	DESCRIPTION
1-2	Connected to +3.3V	Device output boost enabled
2-3*	Connected to GND	Device output boost disabled (standard SATA output levels)
Not installed	Not connected	

\*Default position.

# MAX4951AE Evaluation Kit

## Characterization Circuit (U2)

The characterization circuit is provided as a separate test circuit for eye diagram evaluation of the MAX4951AE IC. This circuit provides differential SMA inputs and outputs with 50 $\Omega$  controlled-impedance traces. Channel B is not utilized in this section of the EV kit, but provides the same performance as channel A.

## Input Supply (VCC)

The characterization circuit is powered by an external +3.3V power supply connected between the VCC and GND pads.

## Device Enable (JU5)

The MAX4951AE (U2) is enabled/disabled by configuring jumper JU5 (see Table 6). When disabled, the MAX4951AE buffers are powered down and the part is placed in low-power mode.

**Table 6. Jumper JU5 Function**

SHUNT POSITION	EN PIN (U2)	DESCRIPTION
1-2*	Connected to +3.3V	Buffers enabled for normal operation
2-3	Connected to GND	Buffers disabled and device is in low-power standby mode

\*Default position.

## Output Boost Control (JU7)

The MAX4951AE's channel A can be evaluated with standard SATA output levels or with boosted output levels. Configure jumper JU7 to enable/disable channel A output boost (see Table 7).

## Calibration Traces

The lower half of the MAX4951AE EV kit provides two sets of calibration traces that can be used for further analysis. The lengths of the calibration traces are matched to the traces going from the SMA connector to MAX4951AE (U2) of the characterization circuit. The first calibration trace includes a 50 $\Omega$  load termination and the second calibration trace is a through trace.

**Table 7. Jumper JU7 Function**

SHUNT POSITION	BA PIN (U2)	DESCRIPTION
1-2	Connected to +3.3V	Channel A output boost enabled
2-3*	Connected to GND	Channel A output boost disabled (standard SATA output levels)
Not installed	Not connected	

\*Default position.

# MAX4951AE Evaluation Kit

Evaluates: MAX4951AE

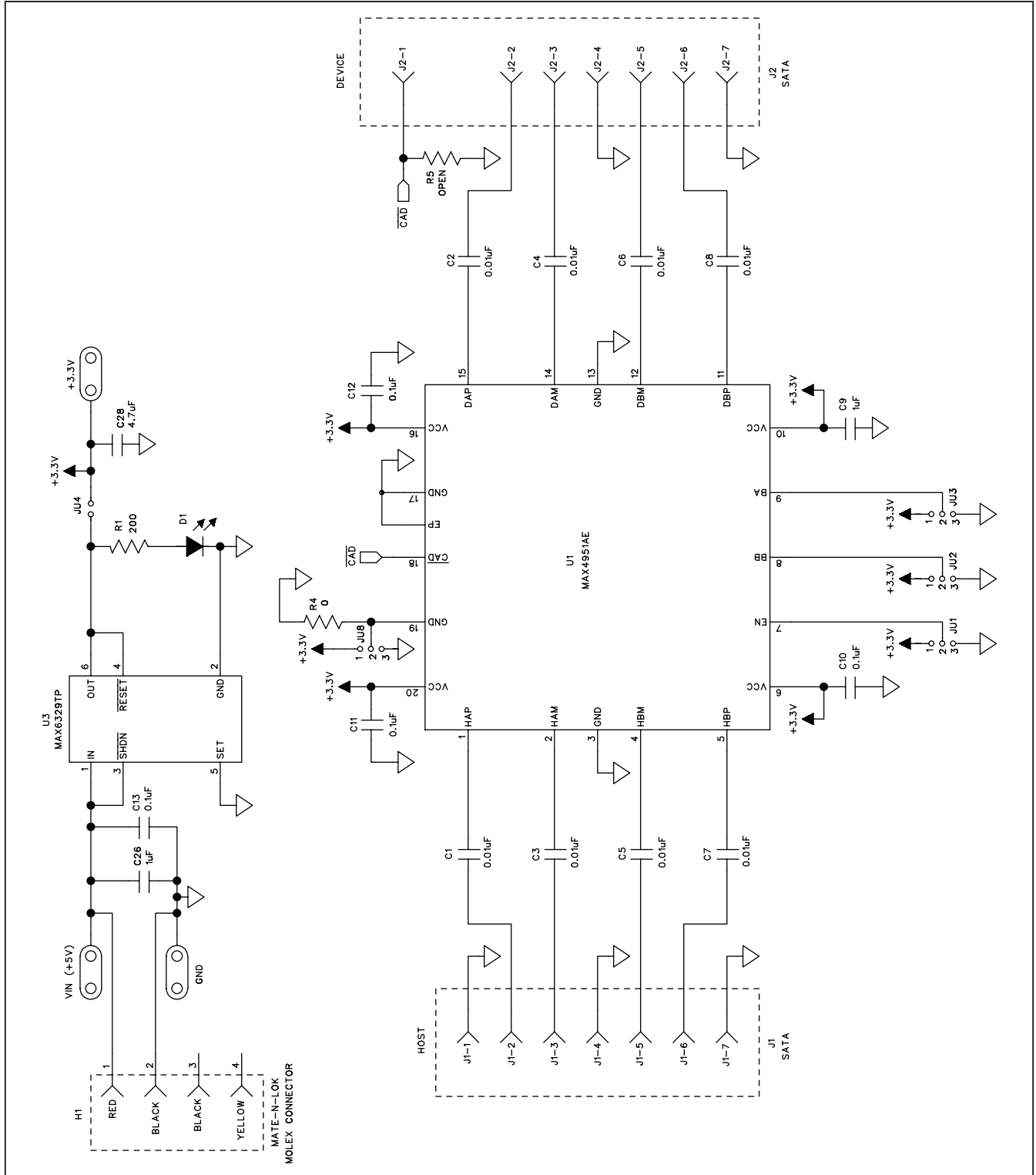

Figure 1a. MAX4951AE EV Kit Schematic—Application Circuit (Sheet 1 of 3)

# MAX4951AE Evaluation Kit

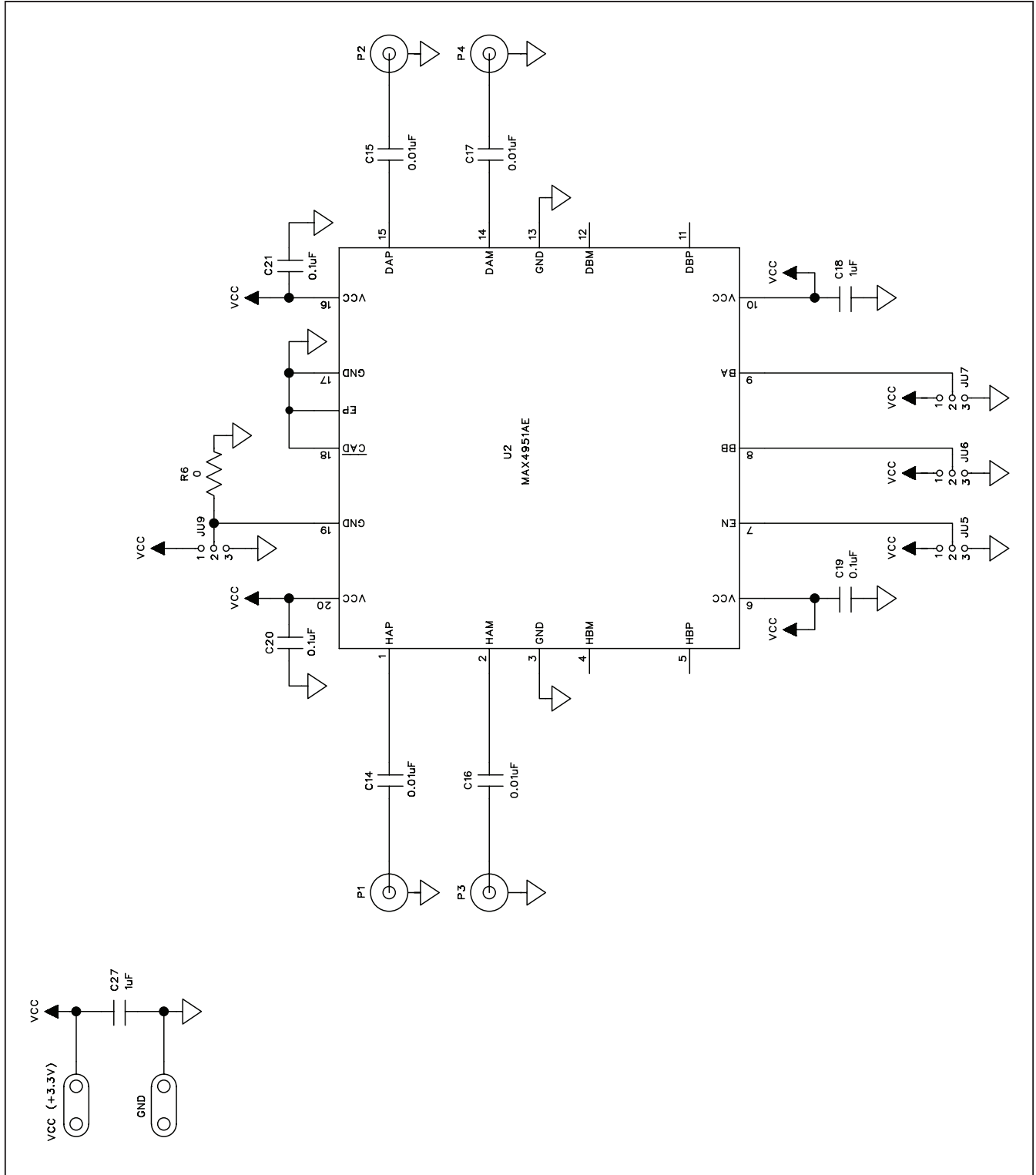

Figure 1b. MAX4951AE EV Kit Schematic—Characterization Circuit (Sheet 2 of 3)

# MAX4951AE Evaluation Kit

Evaluates: MAX4951AE

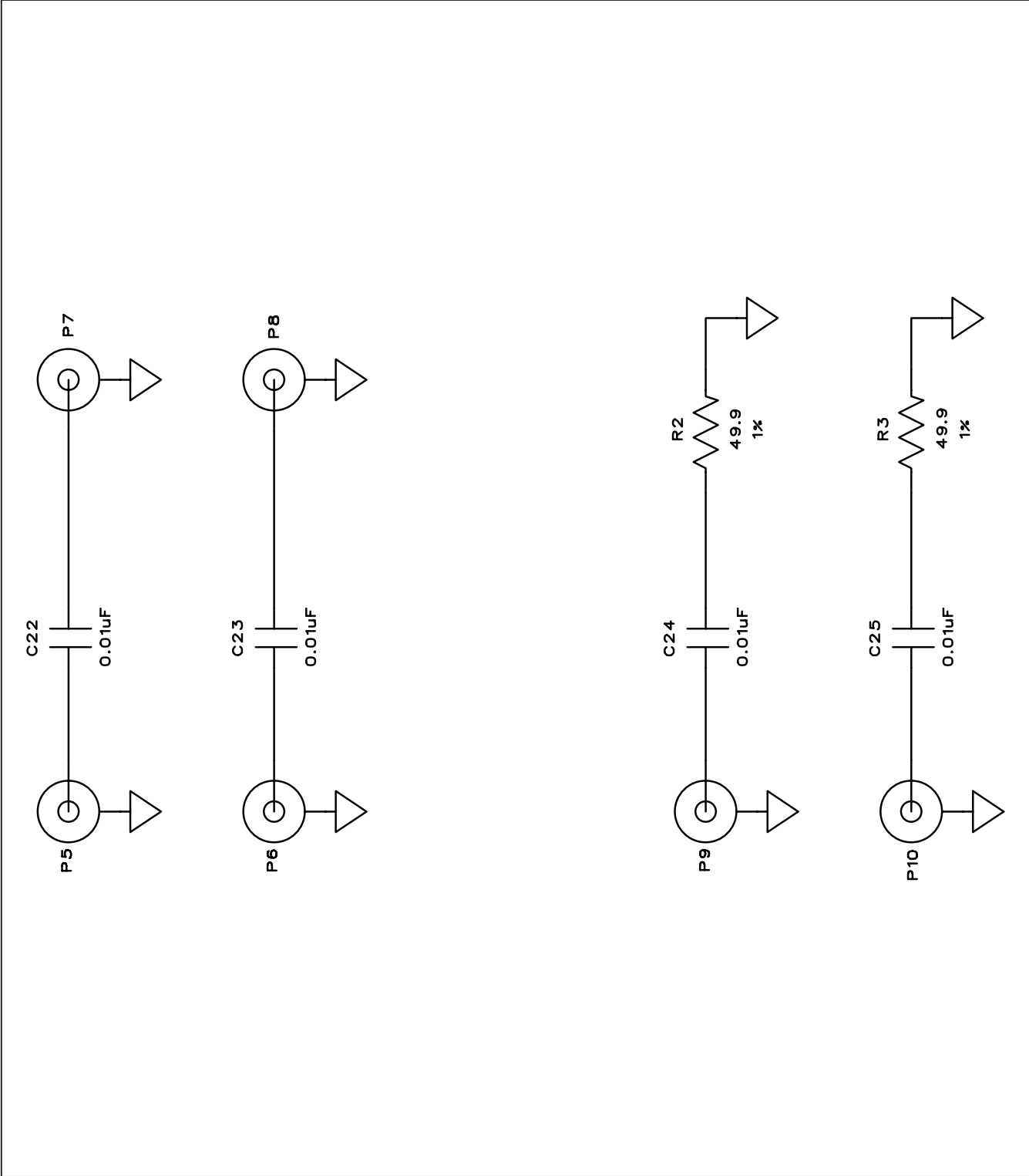

Figure 1c. MAX4951AE EV Kit Schematic—Calibration Traces (Sheet 3 of 3)

# MAX4951AE Evaluation Kit

Evaluates: MAX4951AE

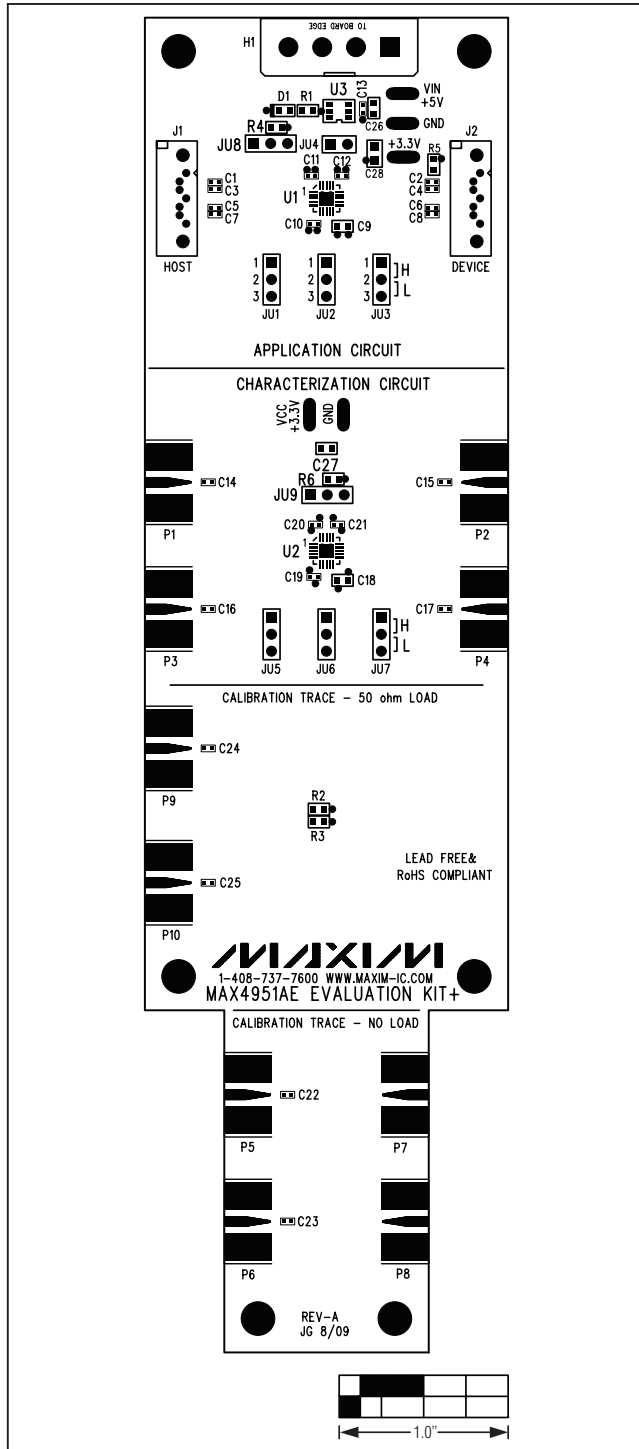

Figure 2. MAX4951AE EV Kit Component Placement Guide—Component Side

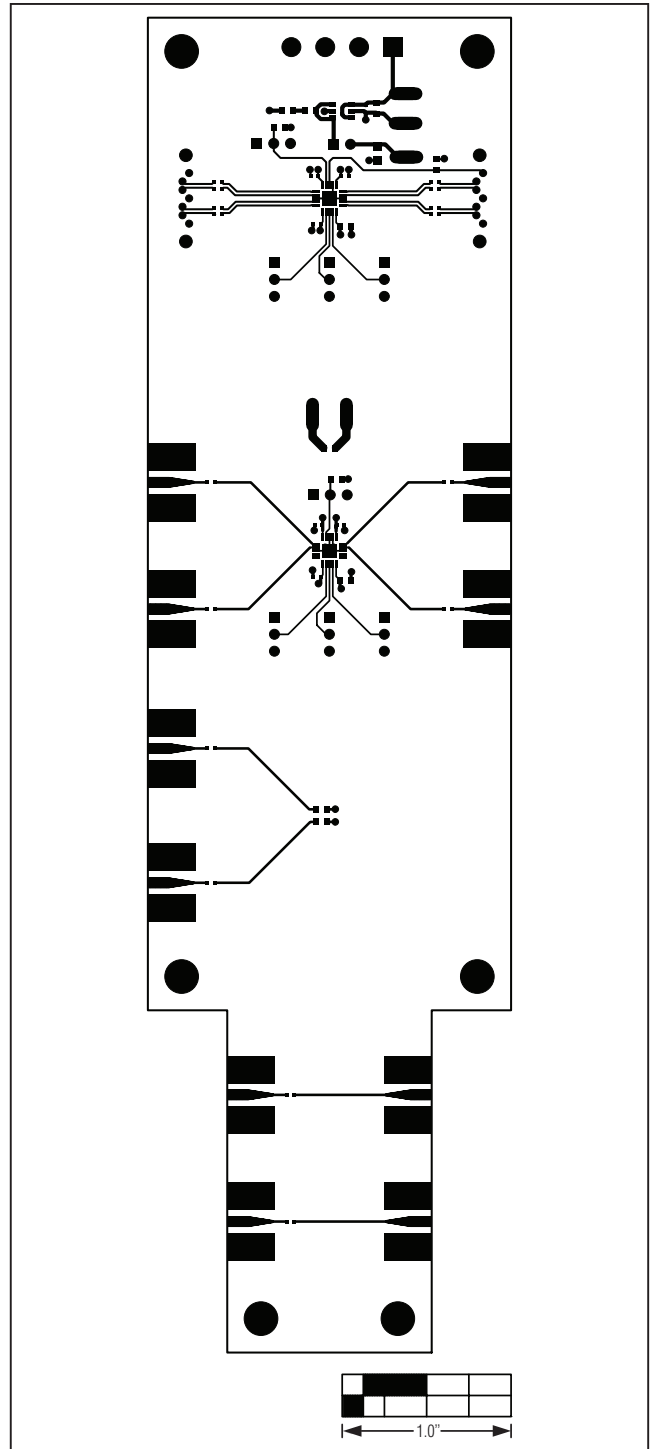

Figure 3. MAX4951AE EV Kit PCB Layout—Component Side



# MAX4951AE Evaluation Kit

Evaluates: MAX4951AE

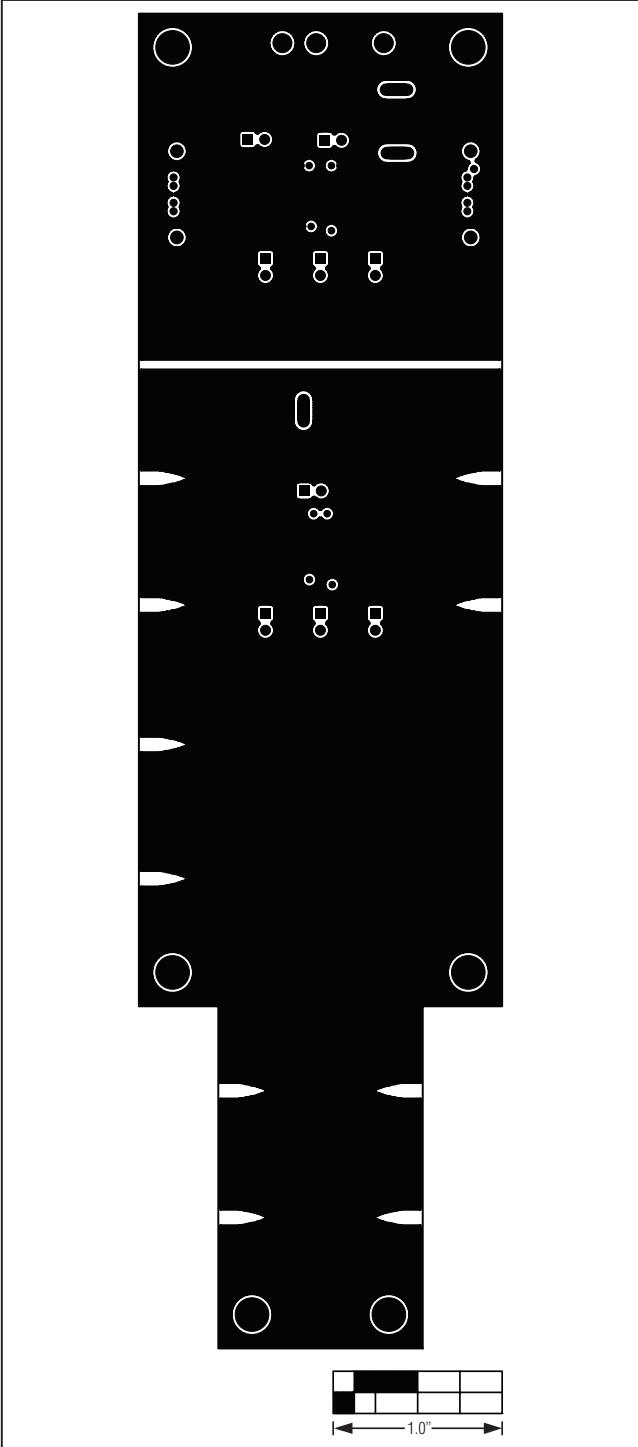

Figure 4. MAX4951AE EV Kit PCB Layout—Inner Layer 2

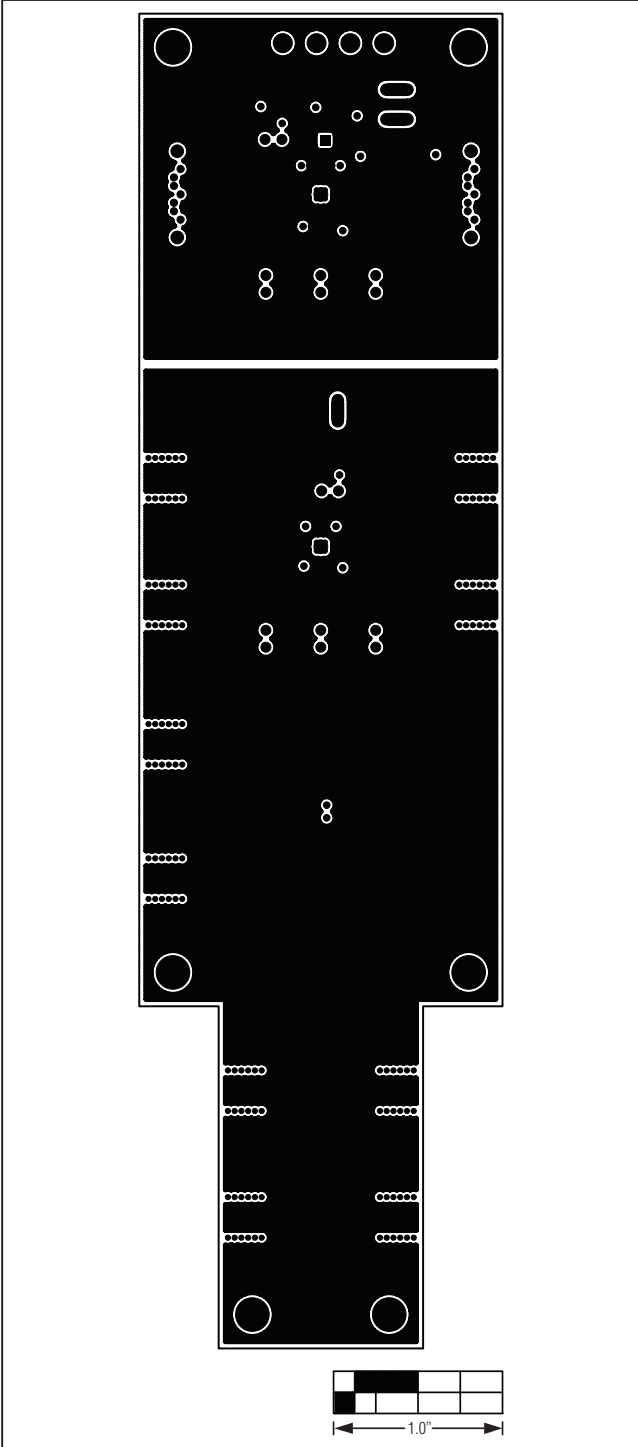

Figure 5. MAX4951AE EV Kit PCB Layout—Inner Layer 3

# MAX4951AE Evaluation Kit

Evaluates: MAX4951AE

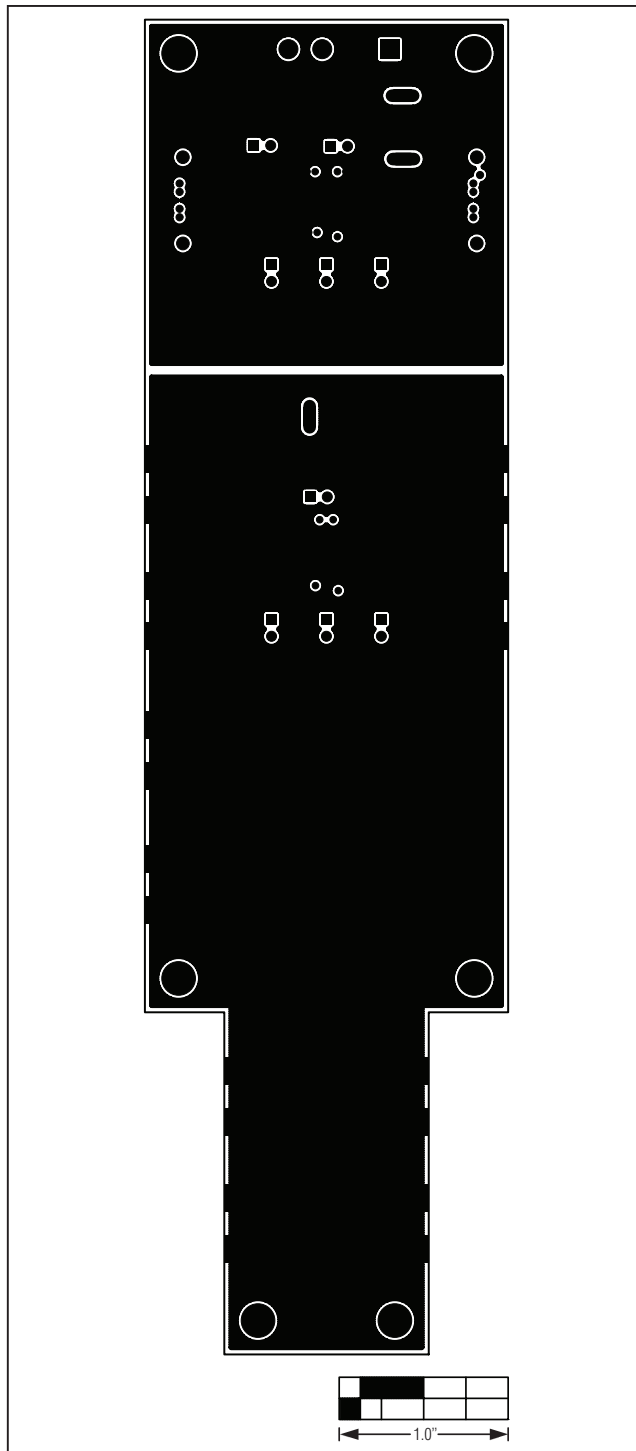

Figure 6. MAX4951AE EV Kit PCB Layout—Solder Side

Maxim cannot assume responsibility for use of any circuitry other than circuitry entirely embodied in a Maxim product. No circuit patent licenses are implied. Maxim reserves the right to change the circuitry and specifications without notice at any time.

10 **Maxim Integrated Products, 120 San Gabriel Drive, Sunnyvale, CA 94086 408-737-7600**

© 2009 Maxim Integrated Products

Maxim is a registered trademark of Maxim Integrated Products, Inc.