

**PART No. IPC1678ST**  
for more information visit  
[www.hammondmg.com](http://www.hammondmg.com)  
Data subject to change without notice  
Isometric drawing Not to Scale

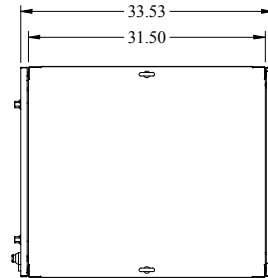

TOP VIEW

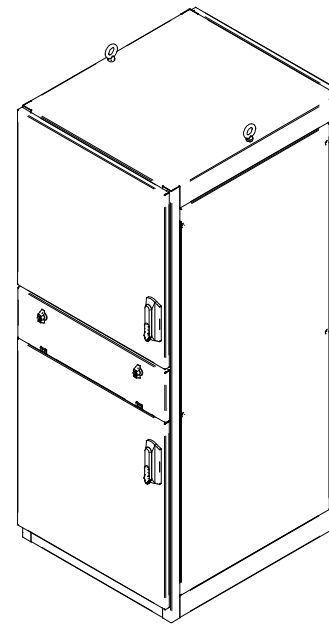
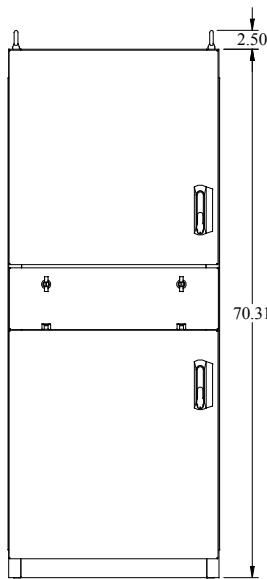

FRONT VIEW

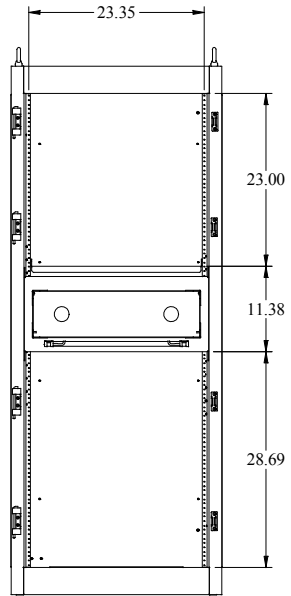

FRONT DOORS REMOVED

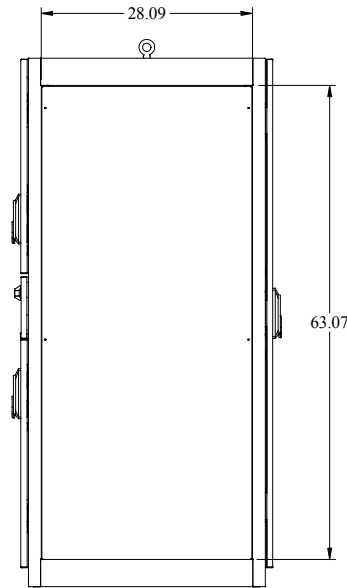

LEFT SIDE VIEW

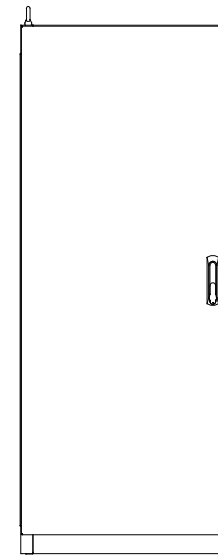

REAR VIEW

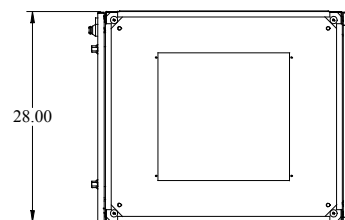

BOTTOM VIEW