

ESC, Aluminum Electrolytic, 105C LowZ, 470 uF, 20%, 25 VDC, -40/+105C, Lead Spacing = 5mm

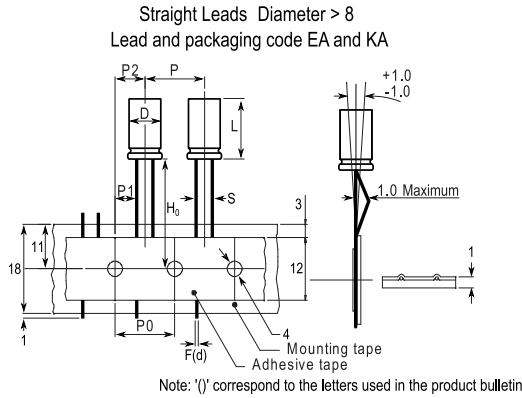

General Information	
Supplier:	KEMET
Series:	ESC
Dielectric:	Aluminum Electrolytic
Description:	LowESR Single Ended Aluminum Electrolytic
Features:	Low ESR
RoHS:	Yes
Lead:	Wire Leads
Notes:	P/P0 = 12.7mm, P1 = 3.85mm, P2 = 6.35mm

Dimensions	
D	10mm +/-0.5mm
L	15mm +2mm
S	5mm +/-0.5mm
H0	18.5mm +/-0.75mm
F	0.6mm NOM

Packaging Specifications	
Packaging:	Ammo
Packaging Quantity:	700

Specifications	
Capacitance:	470 uF
Capacitance Tolerance:	20%
Voltage DC:	25 VDC, 32 VDC (Surge)
Temperature Range:	-40/+105C
Rated Temperature:	105C
Life:	3000 Hrs
Dissipation Factor:	10.00%
Resistance:	0.064 Ohms (100kHz)
Ripple Current:	1050 mAmps (100kHz 105C)
Leakage Current:	117 uA (2min 20C)
Impedance Ratio at -25C:	3
Impedance Ratio at -40C:	4