

Data Sheet

HAL[®] 710, HAL[®] 730,

Hall-Effect Sensors with
Direction Detection

Copyright, Warranty, and Limitation of Liability

The information and data contained in this document are believed to be accurate and reliable. The software and proprietary information contained therein may be protected by copyright, patent, trademark and/or other intellectual property rights of Micronas. All rights not expressly granted remain reserved by Micronas.

Micronas assumes no liability for errors and gives no warranty representation or guarantee regarding the suitability of its products for any particular purpose due to these specifications.

By this publication, Micronas does not assume responsibility for patent infringements or other rights of third parties which may result from its use. Commercial conditions, product availability and delivery are exclusively subject to the respective order confirmation.

Any information and data which may be provided in the document can and do vary in different applications, and actual performance may vary over time.

All operating parameters must be validated for each customer application by customers' technical experts. Any new issue of this document invalidates previous issues. Micronas reserves the right to review this document and to make changes to the document's content at any time without obligation to notify any person or entity of such revision or changes. For further advice please contact us directly.

Do not use our products in life-supporting systems, aviation and aerospace applications! Unless explicitly agreed to otherwise in writing between the parties, Micronas' products are not designed, intended or authorized for use as components in systems intended for surgical implants into the body, or other applications intended to support or sustain life, or for any other application in which the failure of the product could create a situation where personal injury or death could occur.

No part of this publication may be reproduced, photocopied, stored on a retrieval system or transmitted without the express written consent of Micronas.

Micronas Trademarks

– HAL

Micronas Patents

Choppered Offset Compensation protected by Micronas patents no. US5260614, US5406202, EP0525235 and EP0548391.

Third-Party Trademarks

All other brand and product names or company names may be trademarks of their respective companies.

Contents

Page	Section	Title
4	1.	Introduction
4	1.1.	Features
4	1.2.	Family Overview
5	1.3.	Marking Code
5	1.4.	Operating Junction Temperature Range
5	1.5.	HALL Sensor Package Codes
5	1.6.	Solderability and Welding
5	1.7.	Pin Connections
6	2.	Functional Description
9	3.	Specifications
9	3.1.	Outline Dimensions
10	3.2.	Dimensions of Sensitive Area
10	3.3.	Positions of Sensitive Areas
10	3.4.	Absolute Maximum Ratings
10	3.4.1.	Storage and Shelf Life
10	3.5.	Recommended Operating Conditions
11	3.6.	Characteristics
15	4.	Type Description
15	4.1.	HAL 710, HAL 730
17	5.	Application Notes
17	5.1.	Ambient Temperature
17	5.2.	Extended Operating Conditions
17	5.3.	Signal Delay
17	5.4.	Test Mode Activation
18	5.5.	EMC and ESD
18	5.6.	Start-up Behavior
19	6.	Data Sheet History

Hall-Effect Sensors with Direction Detection

Release Note: Revision bars indicate significant changes to the previous edition.

1. Introduction

The HAL 710 and the HAL 730 are monolithic integrated Hall-effect sensors manufactured in CMOS technology with two independent Hall plates S1 and S2 spaced 2.35 mm apart. The devices have two open-drain outputs:

- The Count Output operates like a single latched Hall switch according to the magnetic field present at Hall plate S1 (see Fig. 4–1).
- The Direction Output indicates the direction of a linear or rotating movement of magnetic objects.

In combination with an active target providing a sequence of alternating magnetic north and south poles, the sensors generate the signals required to control position, speed, and direction of the target movement.

The internal circuitry evaluates the direction of the movement and updates the Direction Output at every edge of the Count Signal (rising and falling). The state of the Direction Output only changes at a rising or falling edge of the Count Output.

The design ensures a setup time for the Direction Output with respect to the corresponding Count Signal edge of 1/2 clock periods (1 μ s minimum).

The devices include temperature compensation and active offset compensation. These features provide excellent stability and matching of the switching points in the presence of mechanical stress over the whole temperature and supply voltage range. This is required by systems determining the direction from the comparison of two signals.

The sensors are designed for industrial and automotive applications and operate with supply voltages from 3.8 V to 24 V in the ambient temperature range from $-40\text{ }^{\circ}\text{C}$ up to $125\text{ }^{\circ}\text{C}$.

The HAL 710 and the HAL 730 are available in the SMD-package SOT89B-2.

1.1. Features

- generation of Count Signals and Direction Signals
- delay of the Count Signals with respect to the Direction Signal of 1 μ s minimum
- switching type: latching
- switching offset compensation at typically 150 kHz
- operation from 3.8 V to 24 V supply voltage
- overvoltage protection at all pins
- reverse-voltage protection at V_{DD} -pin
- robustness of magnetic characteristics against mechanical stress
- short-circuit protected open-drain outputs by thermal shut down
- constant switching points over a wide supply voltage range
- EMC corresponding to ISO 7637

1.2. Family Overview

The types differ according to the behavior of the Direction Output.

Type	Direction Output: Definition of Output States
HAL 710	Output high, when edge of comparator 1 precedes edge of comparator 2
HAL 730	Output high, when edge of comparator 2 precedes edge of comparator 1

1.3. Marking Code

All Hall sensors have a marking on the package surface (branded side). This marking includes the name of the sensor and the temperature range.

Type	Temperature Range	
	K	E
HAL 710	710K	710E
HAL 730	730K	730E

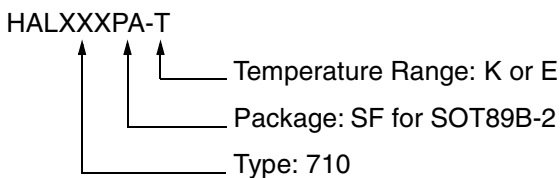

Example: **HAL710SF-K**

- Type: 710
- Package: SOT89B-2
- Temperature Range: $T_J = -40\text{ °C to }+140\text{ °C}$

Hall sensors are available in a wide variety of packaging versions and quantities. For more detailed information, please refer to the brochure: “Hall Sensors: Ordering Codes, Packaging, Handling”.

1.6. Solderability and Welding

Solderability

During soldering reflow processing and manual reworking, a component body temperature of 260 °C should not be exceeded.

Welding

Device terminals should be compatible with laser and resistance welding. Please note that the success of the welding process is subject to different welding parameters which will vary according to the welding technique used. A very close control of the welding parameters is absolutely necessary in order to reach satisfying results. Micronas, therefore, does not give any implied or express warranty as to the ability to weld the component.

1.4. Operating Junction Temperature Range

The Hall sensors from Micronas are specified to the chip temperature (junction temperature T_J).

K: $T_J = -40\text{ °C to }+140\text{ °C}$

E: $T_J = -40\text{ °C to }+100\text{ °C}$

Note: Due to power dissipation, there is a difference between the ambient temperature (T_A) and junction temperature. Please refer to section 5.1. on page 17 for details.

1.7. Pin Connections

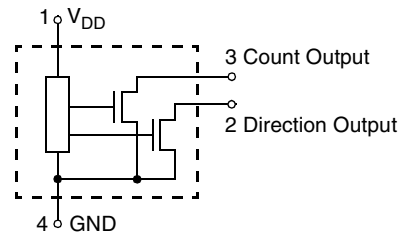

Fig. 1–1: Pin configuration

2. Functional Description

The HAL 710 and the HAL 730 are monolithic integrated circuits with two independent subblocks each consisting of a Hall plate and the corresponding comparator. Each subblock independently switches the comparator output in response to the magnetic field at the location of the corresponding sensitive area. If a magnetic field with flux lines perpendicular to the sensitive area is present, the biased Hall plate generates a Hall voltage proportional to this field. The Hall voltage is compared with the actual threshold level in the comparator.

The output of comparator 1 (connected to S1) directly controls the Count Output. The outputs of both comparators enter the Direction Detection Block controlling the state of the Direction Output. The Direction Output is updated at every edge of comparator 1 (rising and falling). The previous state of the Direction Output is maintained between two edges of the Count Output and in case the edges at comparator 1 and comparator 2 occur in the same clock period. The subblocks are designed to have closely matched switching points.

The temperature-dependent bias – common to both subblocks – increases the supply voltage of the Hall plates and adjusts the switching points to the decreasing induction of magnets at higher temperatures. If the magnetic field exceeds the threshold levels, the comparator switches to the appropriate state. The built-in hysteresis prevents oscillations of the outputs.

In order to achieve good matching of the switching points of both subblocks, the magnetic offset caused by mechanical stress is compensated for by use of switching offset compensation techniques. Therefore, an internal oscillator provides a two-phase clock to both subblocks. For each subblock, the Hall voltage is sampled at the end of the first phase. At the end of the second phase, both sampled and actual Hall voltages are averaged and compared with the actual switching point.

Shunt protection devices clamp voltage peaks at the output pins and V_{DD} -pin together with external series resistors. Reverse current is limited at the V_{DD} -pin by an internal series resistor up to -15 V . No external reverse protection diode is needed at the V_{DD} -pin for reverse voltages ranging from 0 V to -15 V .

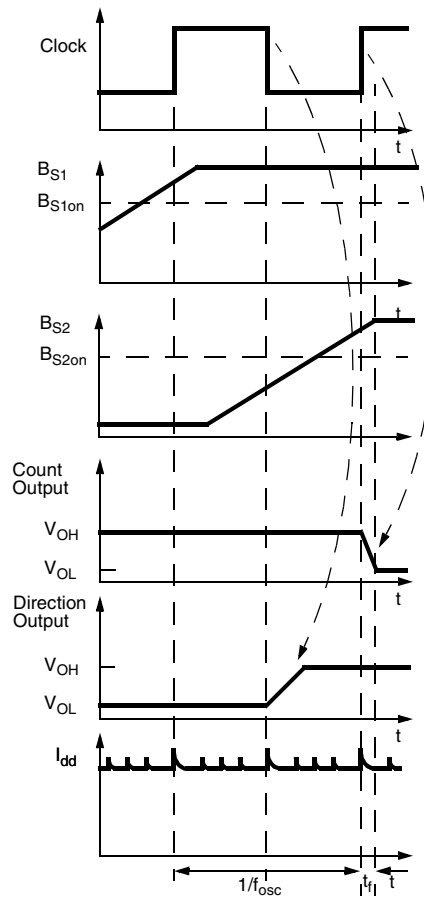

Fig. 2-1: HAL 710 timing diagram with respect to the clock phase

Fig. 2-2 and Fig. 2-3 on page 7 show how the output signals are generated by the HAL 710 and the HAL 730. The magnetic flux density at the locations of the two Hall plates is shown by the two sinusoidal curves at the top of each diagram. The magnetic switching points are depicted as dashed lines for each Hall plate separately.

At the time $t = 0$, the signal S2 precedes the signal S1. The Direction Output is in the correct state according to the definition of the sensor type.

When the phase of the magnetic signal changes its sign, the Direction-Output switches its state with the next signal edge of the Count Output.

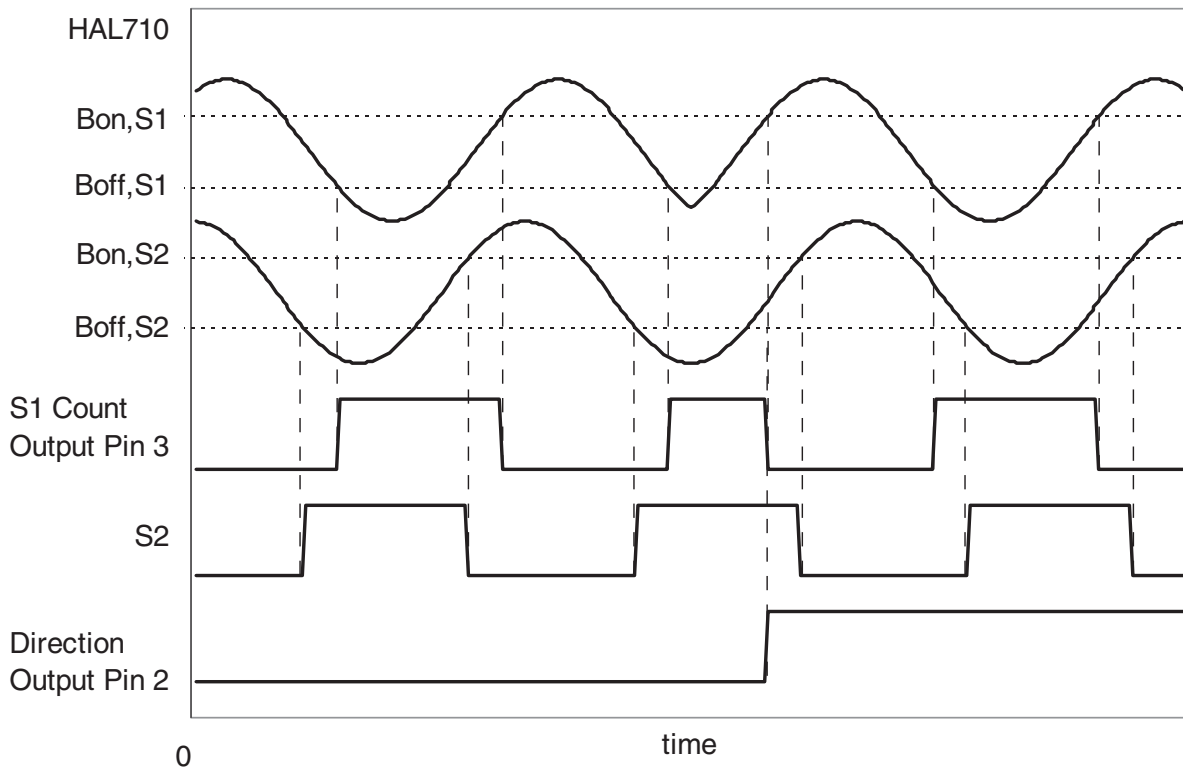

Fig. 2-2: HAL 710 timing diagram

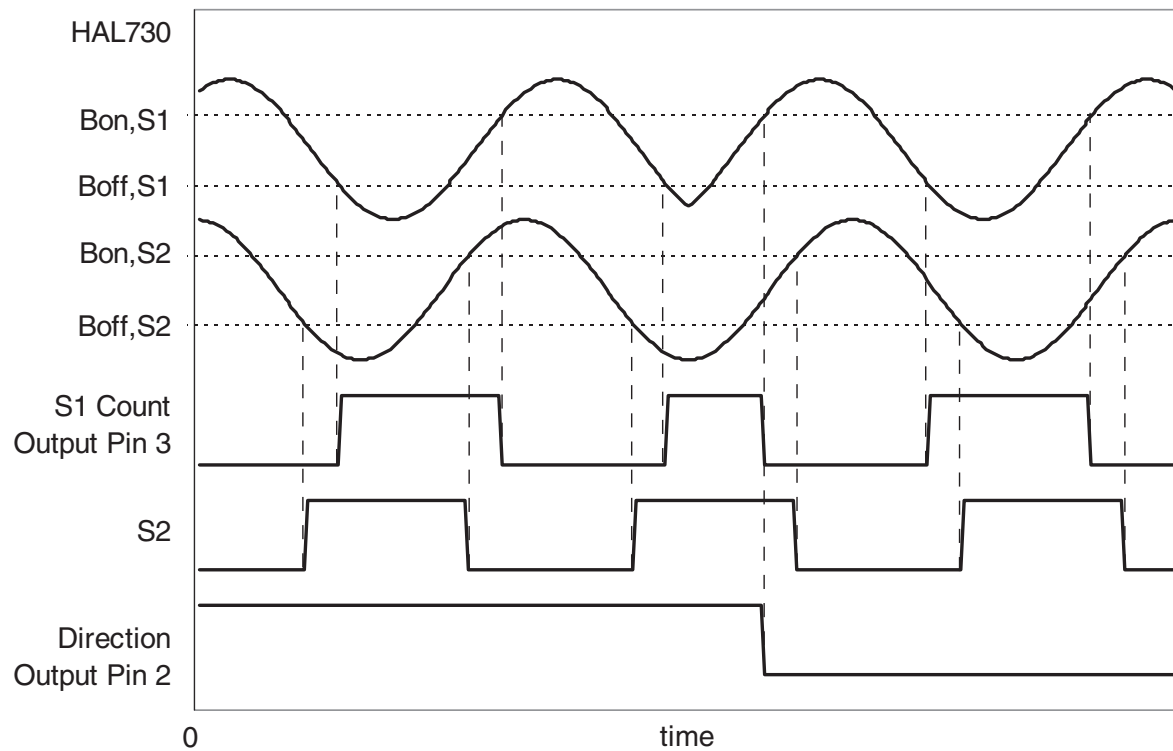

Fig. 2-3: HAL 730 timing diagram

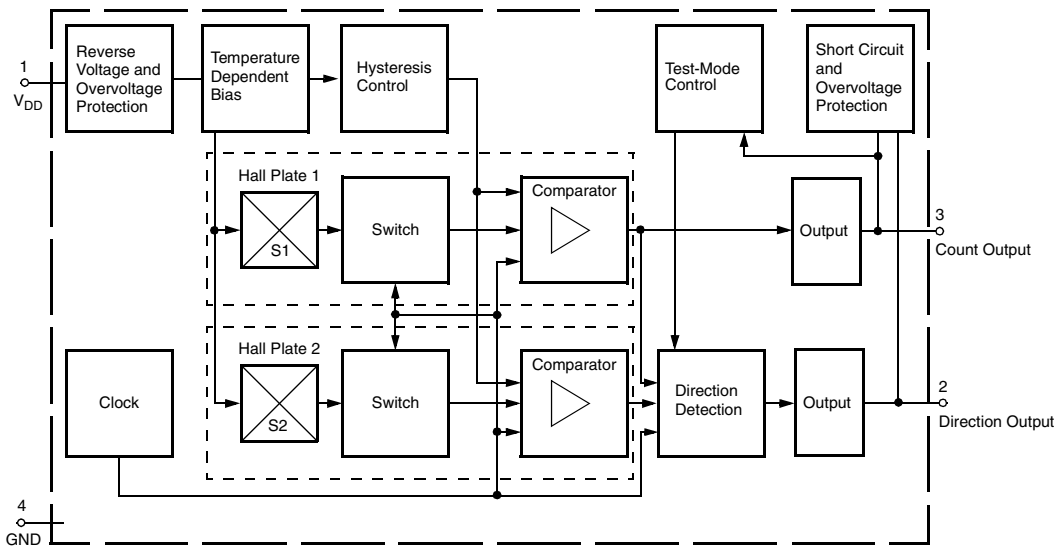

Fig. 2-4: HAL 710 and HAL 730 block diagram

3. Specifications

3.1. Outline Dimensions

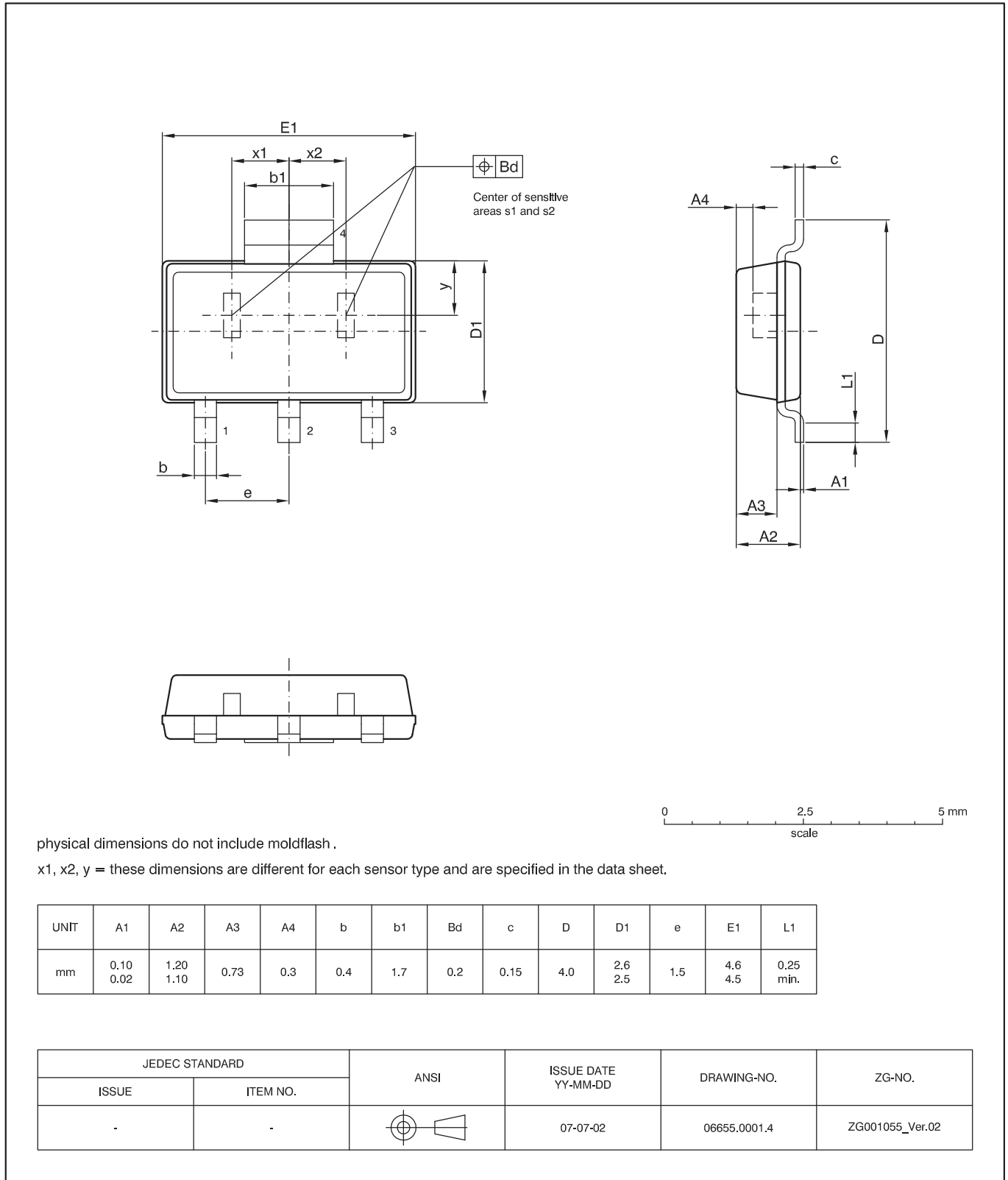

Fig. 3-1:
SOT89B-2: Plastic Small Outline Transistor package, 4 leads, with two sensitive areas
 Weight approximately 0.034 g

3.2. Dimensions of Sensitive Area

0.25 mm × 0.12 mm

3.3. Positions of Sensitive Areas

	SOT89B-2
$x_1 + x_2$	(2.35±0.001) mm
$x_1 = x_2$	1.175 mm
y	0.975 mm

3.4. Absolute Maximum Ratings

Stresses beyond those listed in the “Absolute Maximum Ratings” may cause permanent damage to the device. This is a stress rating only. Functional operation of the device at these conditions is not implied. Exposure to absolute maximum rating conditions for extended periods will affect device reliability.

This device contains circuitry to protect the inputs and outputs against damage due to high static voltages or electric fields; however, it is advised that normal precautions be taken to avoid application of any voltage higher than absolute maximum-rated voltages to this high-impedance circuit.

All voltages listed are referenced to ground (GND).

Symbol	Parameter	Pin No.	Min.	Max.	Unit
V_{DD}	Supply Voltage	1	-15	28 ¹⁾	V
V_O	Output Voltage	2, 3	-0.3	28 ¹⁾	V
I_O	Continuous Output Current	2, 3	-	20 ¹⁾	mA
T_J	Junction Temperature Range		-40	170	°C

¹⁾ as long as T_{Jmax} is not exceeded

3.4.1. Storage and Shelf Life

The permissible storage time (shelf life) of the sensors is unlimited, provided the sensors are stored at a maximum of 30 °C and a maximum of 85% relative humidity. At these conditions, no Dry Pack is required.

Solderability is guaranteed for one year from the date code on the package.

3.5. Recommended Operating Conditions

Functional operation of the device beyond those indicated in the “Recommended Operating Conditions” of this specification is not implied, may result in unpredictable behavior of the device and may reduce reliability and lifetime.

All voltages listed are referenced to ground (GND).

Symbol	Parameter	Pin No.	Min.	Typ.	Max.	Unit
V_{DD}	Supply Voltage	1	3.8	-	24	V
I_O	Continuous Output Current	3	0	-	10	mA
V_O	Output Voltage (output switch off)	3	0	-	24	V

3.6. Characteristics

at $T_J = -40\text{ }^\circ\text{C}$ to $+140\text{ }^\circ\text{C}$, $V_{DD} = 3.8\text{ V}$ to 24 V , $GND = 0\text{ V}$

at Recommended Operation Conditions if not otherwise specified in the column "Conditions".

Typical Characteristics for $T_J = 25\text{ }^\circ\text{C}$ and $V_{DD} = 5\text{ V}$.

Symbol	Parameter	Pin No.	Min.	Typ.	Max.	Unit	Test Conditions
I_{DD}	Supply Current	1	3	5.5	9	mA	$T_J = 25\text{ }^\circ\text{C}$
I_{DD}	Supply Current over Temperature Range	1	2	7	10	mA	
V_{DDZ}	Overshoot Protection at Supply	1	-	28.5	32	V	$I_{DD} = 25\text{ mA}$, $T_J = 25\text{ }^\circ\text{C}$, $t = 2\text{ ms}$
V_{OZ}	Overshoot Protection at Output	2,3	-	28	32	V	$I_{OL} = 20\text{ mA}$, $T_J = 25\text{ }^\circ\text{C}$, $t = 15\text{ ms}$
V_{OL}	Output Voltage	2,3	-	130	280	mV	$I_{OL} = 10\text{ mA}$, $T_J = 25\text{ }^\circ\text{C}$
V_{OL}	Output Voltage over Temperature Range	2,3	-	130	400	mV	$I_{OL} = 10\text{ mA}$,
I_{OH}	Output Leakage Current	2,3	-	0.06	0.1	μA	Output switched off, $T_J = 25\text{ }^\circ\text{C}$, $V_{OH} = 3.8\text{ V}$ to 24 V
I_{OH}	Output Leakage Current over Temperature Range	2,3	-	-	10	μA	Output switched off, $T_J \leq 140\text{ }^\circ\text{C}$, $V_{OH} = 3.8\text{ V}$ to 24 V
f_{osc}	Internal Sampling Frequency over Temperature Range	-	100	150	-	kHz	
$t_{en(O)}$	Enable Time of Output after Setting of V_{DD}	1	-	50	-	μs	$V_{DD} = 12\text{ V}$, $B > B_{on} + 2\text{ mT}$ or $B < B_{off} - 2\text{ mT}$
t_r	Output Rise Time	2,3	-	0.2	-	μs	$V_{DD} = 12\text{ V}$, $R_L = 2.4\text{ k}\Omega$, $C_L = 20\text{ pF}$
t_f	Output FallTime	2,3	-	0.2	-	μs	$V_{DD} = 12\text{ V}$, $R_L = 2.4\text{ k}\Omega$, $C_L = 20\text{ pF}$
R_{thSB} case SOT89B-2	Thermal Resistance Junction to Substrate Backside	-	-	150	200	K/W	Fiberglass Substrate 30 mm x 10 mm x 1.5 mm, pad size

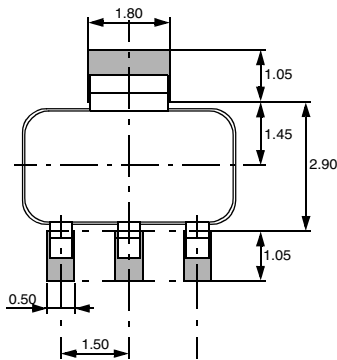
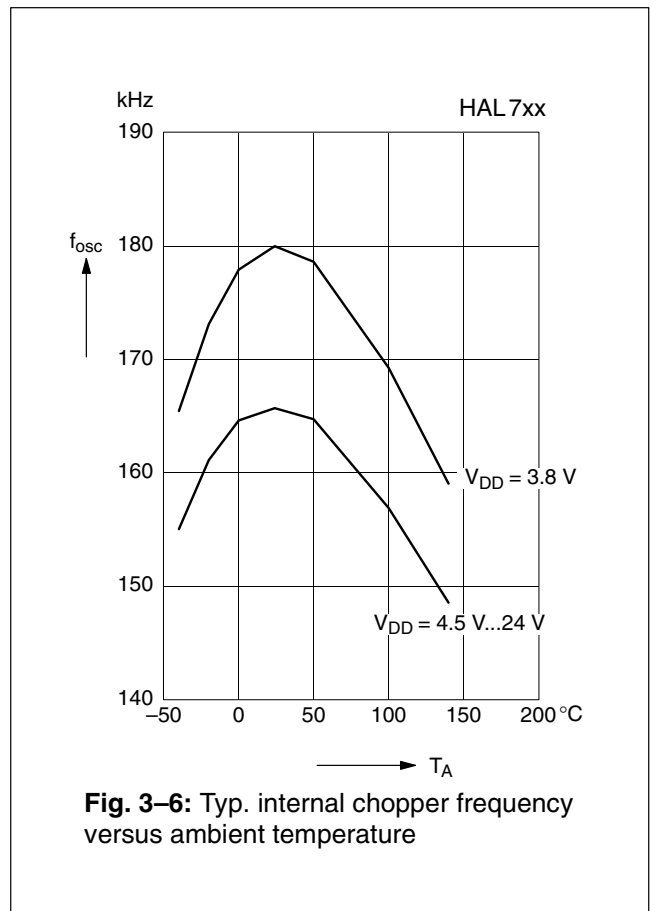
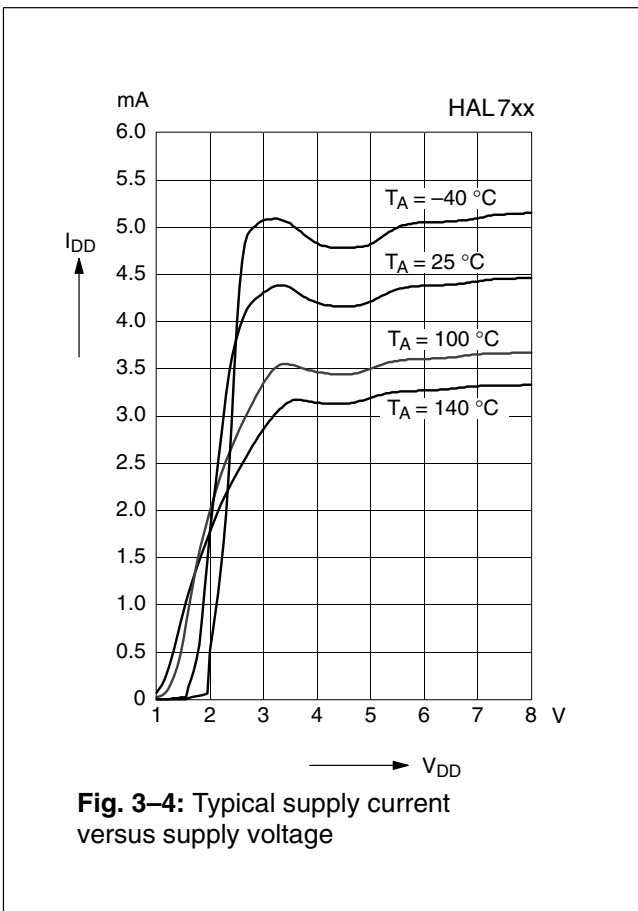
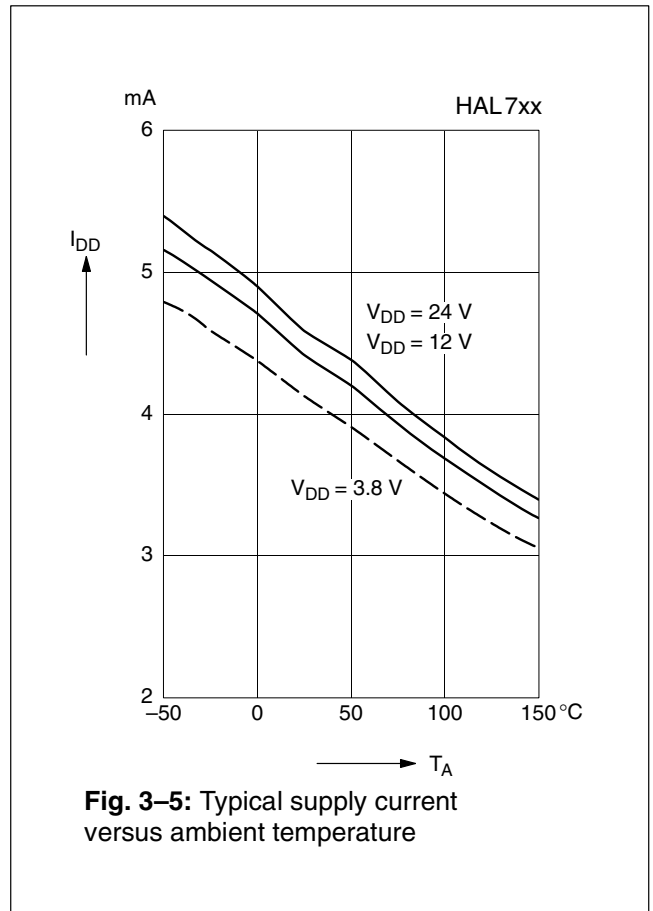
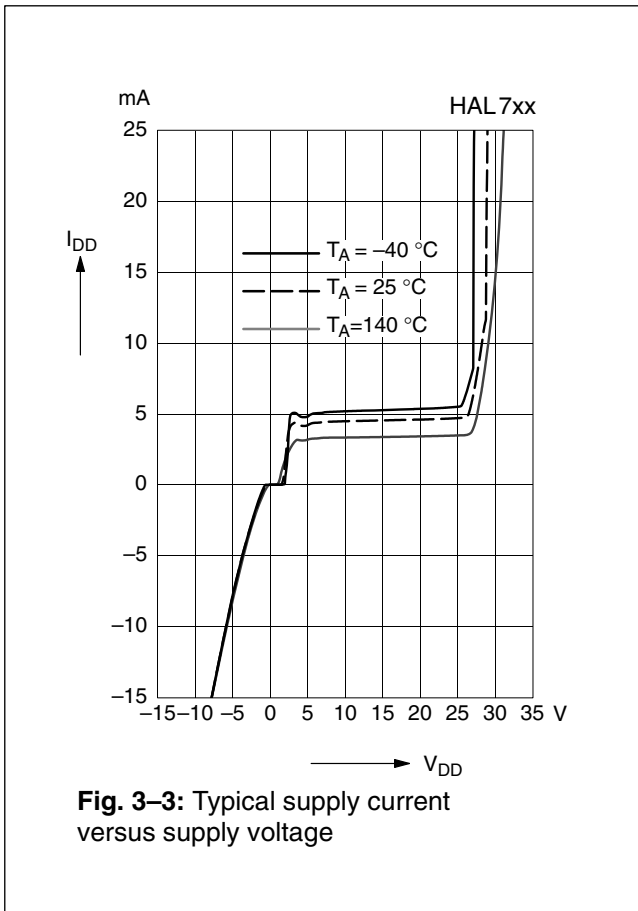

Fig. 3-2: Recommended pad size SOT89B-2
Dimensions in mm



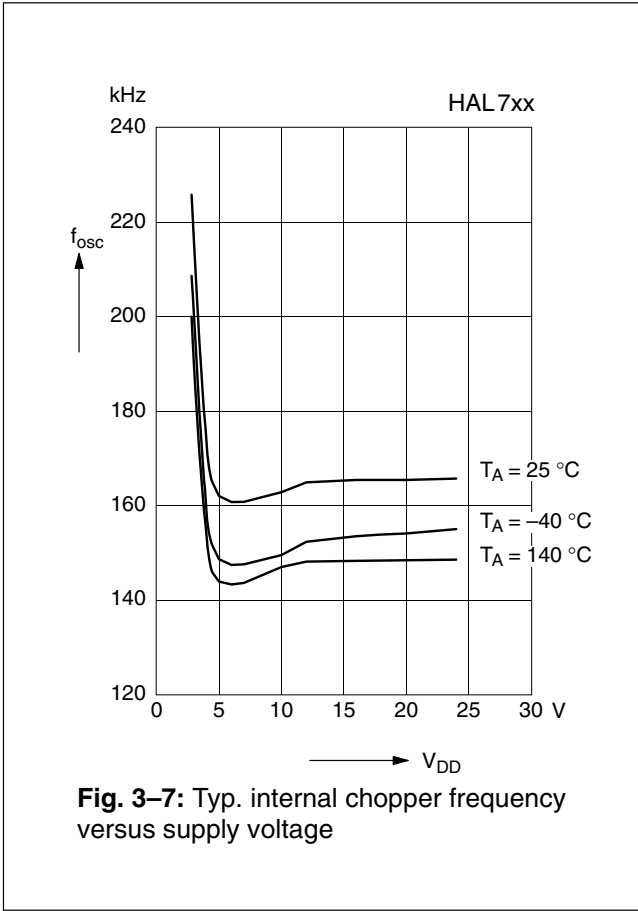

Fig. 3-7: Typ. internal chopper frequency versus supply voltage

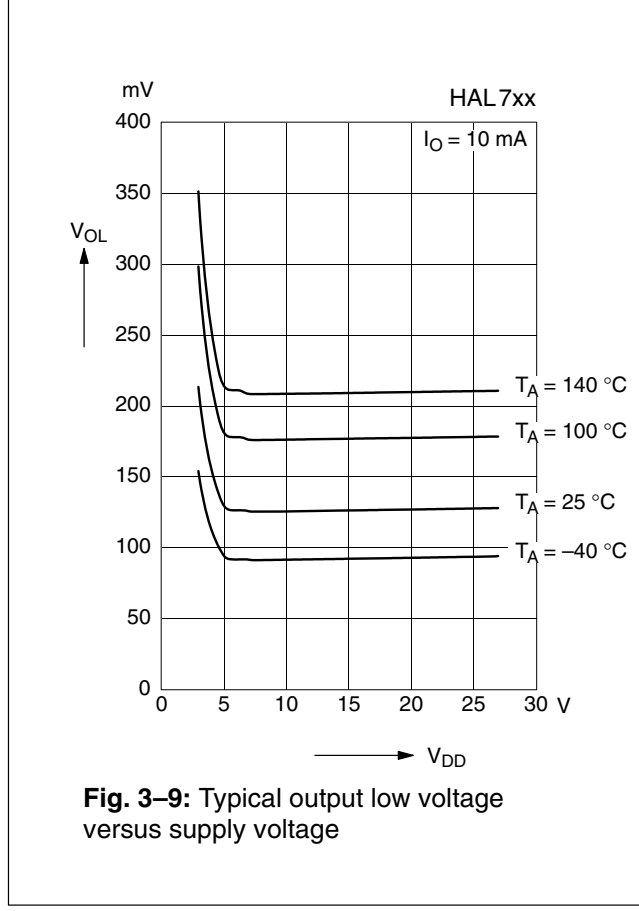

Fig. 3-9: Typical output low voltage versus supply voltage

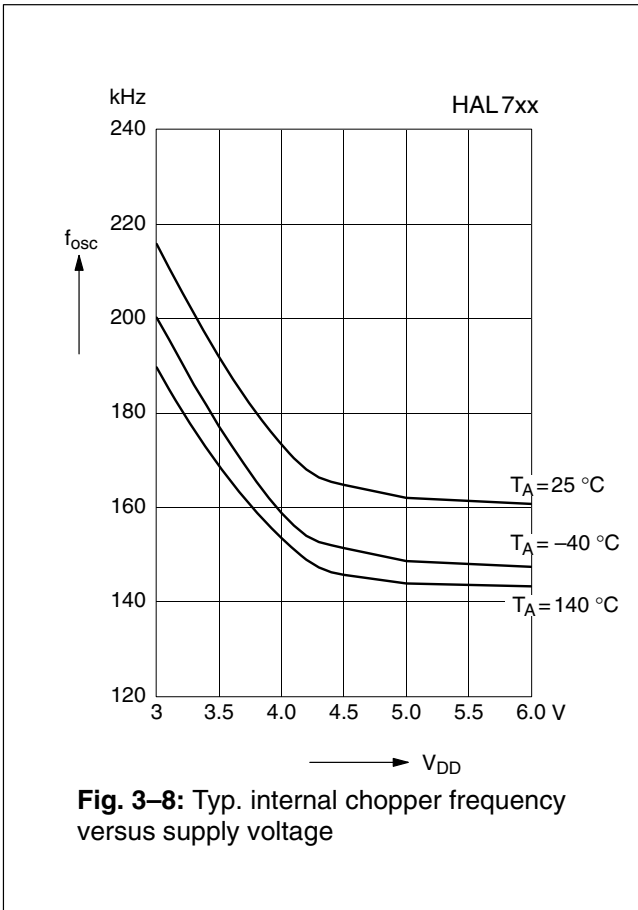

Fig. 3-8: Typ. internal chopper frequency versus supply voltage

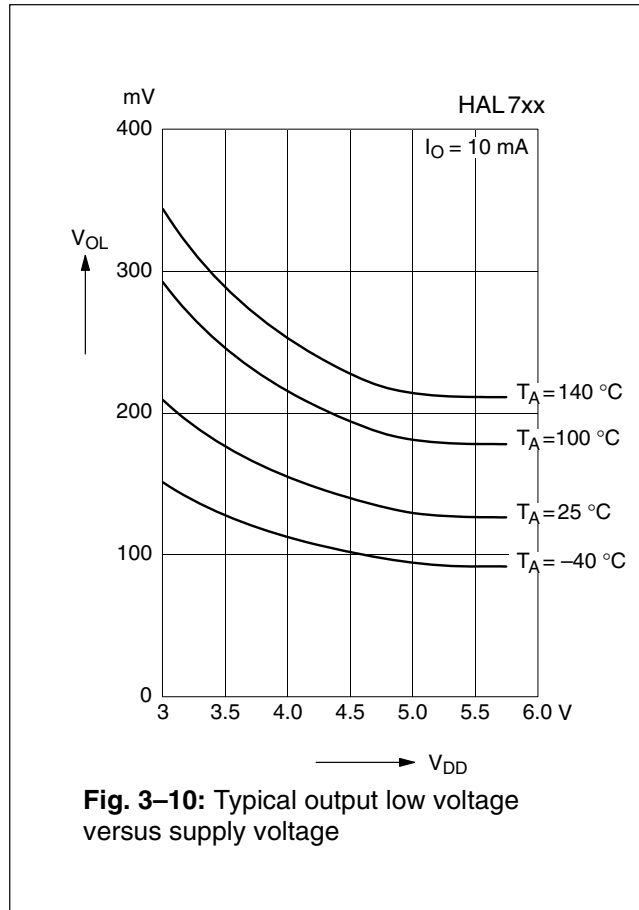
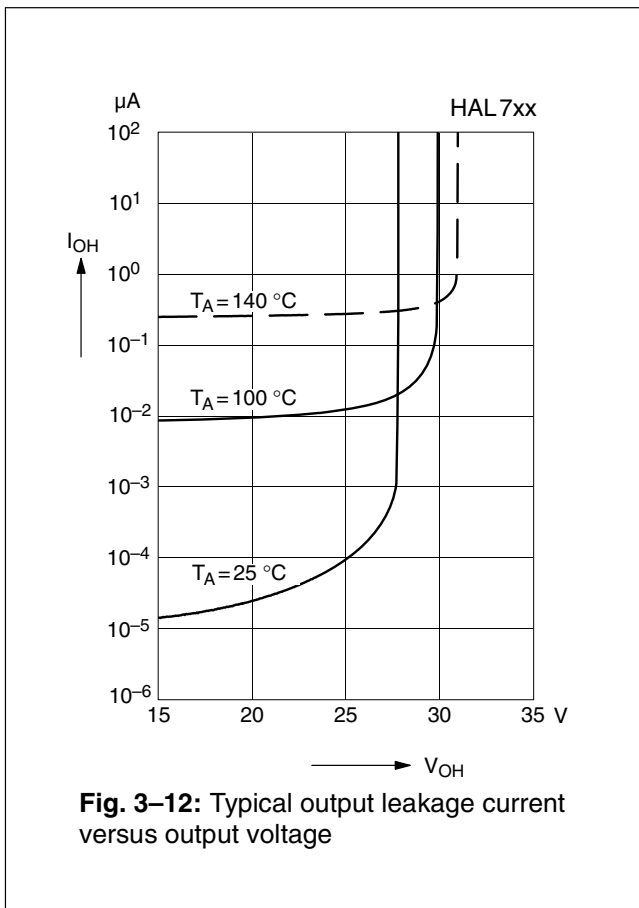
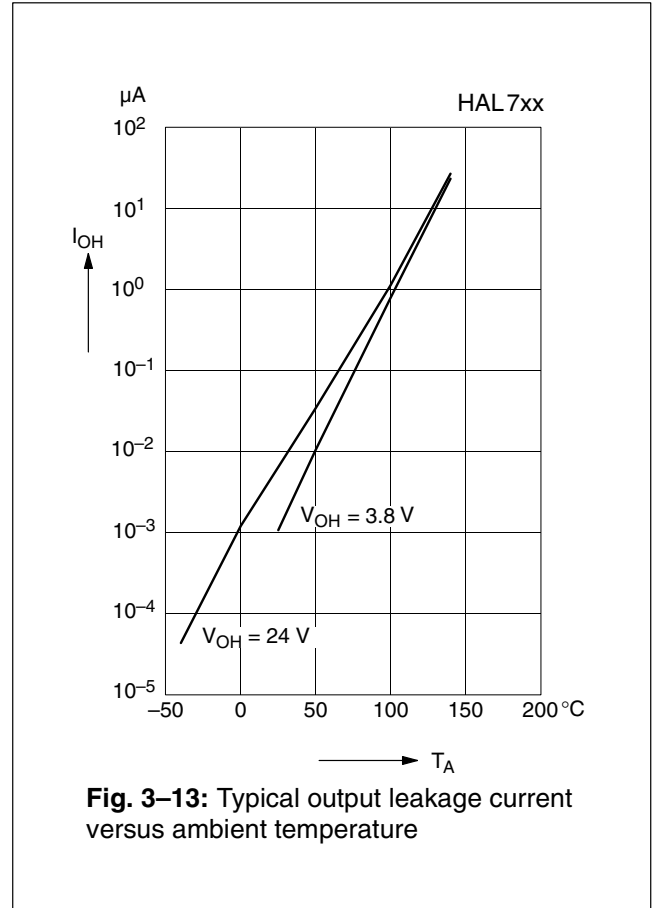
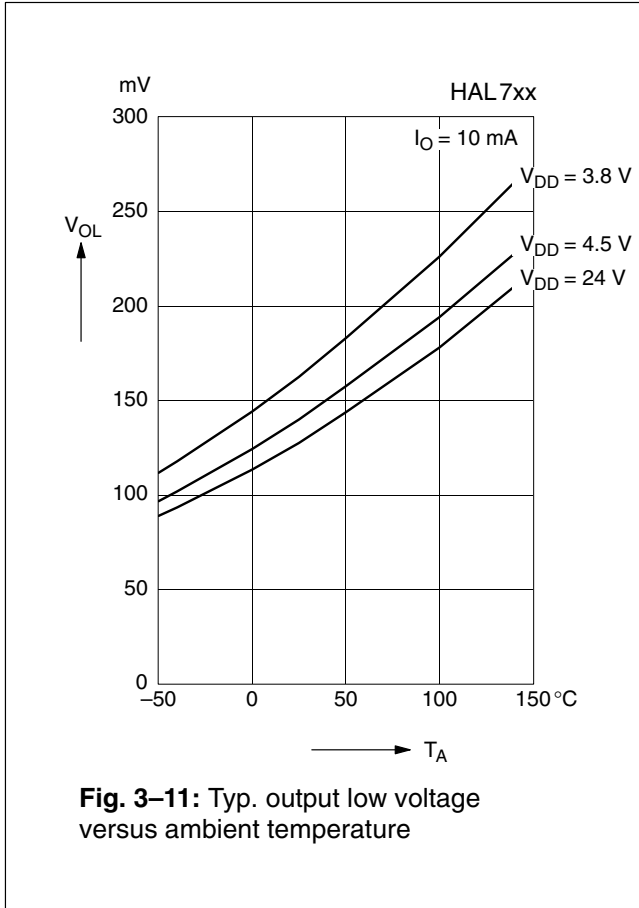

Fig. 3-10: Typical output low voltage versus supply voltage



4. Type Description

4.1. HAL 710, HAL 730

The types differ according to the behavior of the Direction Output (see Section 1.2. on page 4).

Magnetic Features

- typical B_{ON} : 14.9 mT at room temperature
- typical B_{OFF} : -14.9 mT at room temperature
- temperature coefficient of -2000 ppm/K in all magnetic characteristics
- operation with static magnetic fields and dynamic magnetic fields up to 10 kHz

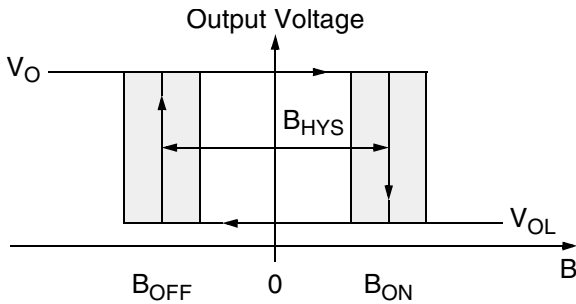

Fig. 4-1: Definition of magnetic switching points for the HAL 710

Positive flux density values refer to magnetic south pole at the branded side of the package.

Applications

The HAL 710 and the HAL 730 are the optimal sensors for position-control applications with direction detection and alternating magnetic signals such as:

- multipole magnet applications,
- rotating speed and direction measurement, position tracking (active targets), and
- window lifters.

Magnetic Thresholds

(quasi stationary: $dB/dt < 0.5$ mT/ms)

at $T_J = -40$ °C to $+140$ °C, $V_{DD} = 3.8$ V to 24 V, as not otherwise specified

Typical characteristics for $T_J = 25$ °C and $V_{DD} = 5$ V

Parameter	On-Point B_{S1on}, B_{S2on}			Off-Point B_{S1off}, B_{S2off}			Unit
	Min.	Typ.	Max.	Min.	Typ.	Max.	
T_J							
-40 °C	12.5	16.3	20	-20	-16.3	-12.5	mT
25 °C	10.7	14.9	19.1	-19.1	-14.9	-10.7	mT
100 °C	7.7	12.5	17.3	-17.3	-12.5	-7.7	mT
140 °C	6.0	10.9	16.0	-16.0	-10.9	-6.0	mT

Matching B_{S1} and B_{S2}

(quasi stationary: $dB/dt < 0.5$ mT/ms)

at $T_J = -40$ °C to $+140$ °C, $V_{DD} = 3.8$ V to 24 V, as not otherwise specified

Typical characteristics for $T_J = 25$ °C and $V_{DD} = 5$ V

Parameter	$B_{S1on} - B_{S2on}$			$B_{S1off} - B_{S2off}$			Unit
	Min.	Typ.	Max.	Min.	Typ.	Max.	
T_J							
-40 °C	-7.5	0	7.5	-7.5	0	7.5	mT
25 °C	-7.5	0	7.5	-7.5	0	7.5	mT
100 °C	-7.5	0	7.5	-7.5	0	7.5	mT
140 °C	-7.5	0	7.5	-7.5	0	7.5	mT

Hysteresis Matching

(quasi stationary: $dB/dt < 0.5$ mT/ms)

at $T_J = -40$ °C to $+140$ °C, $V_{DD} = 3.8$ V to 24 V, as not otherwise specified

Typical characteristics for $T_J = 25$ °C and $V_{DD} = 5$ V

Parameter	$(B_{S1on} - B_{S1off}) / (B_{S2on} - B_{S2off})$			Unit
	Min.	Typ.	Max.	
T_J				
-40 °C	0.85	1.0	1.2	-
25 °C	0.85	1.0	1.2	-
100 °C	0.85	1.0	1.2	-
140 °C	0.85	1.0	1.2	-

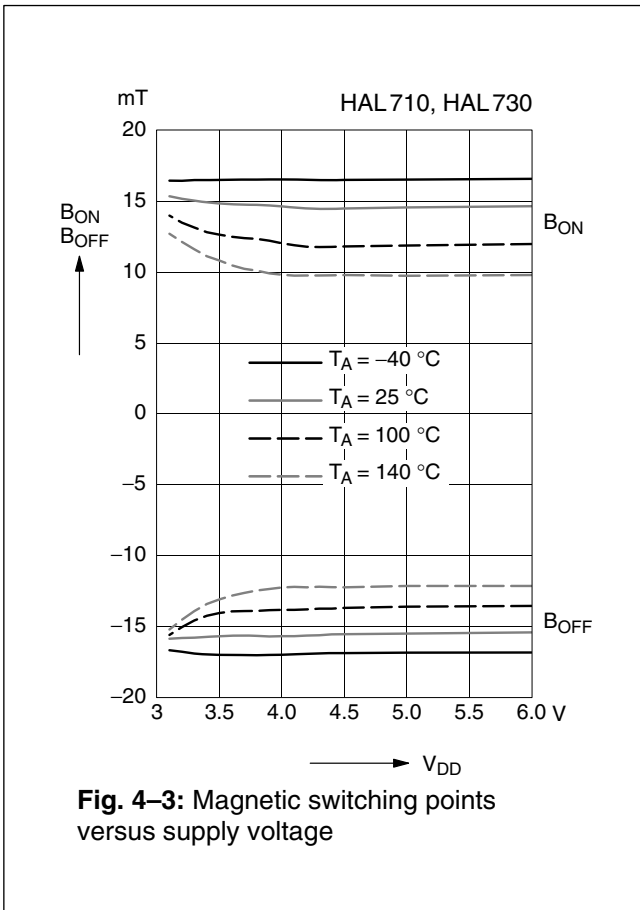
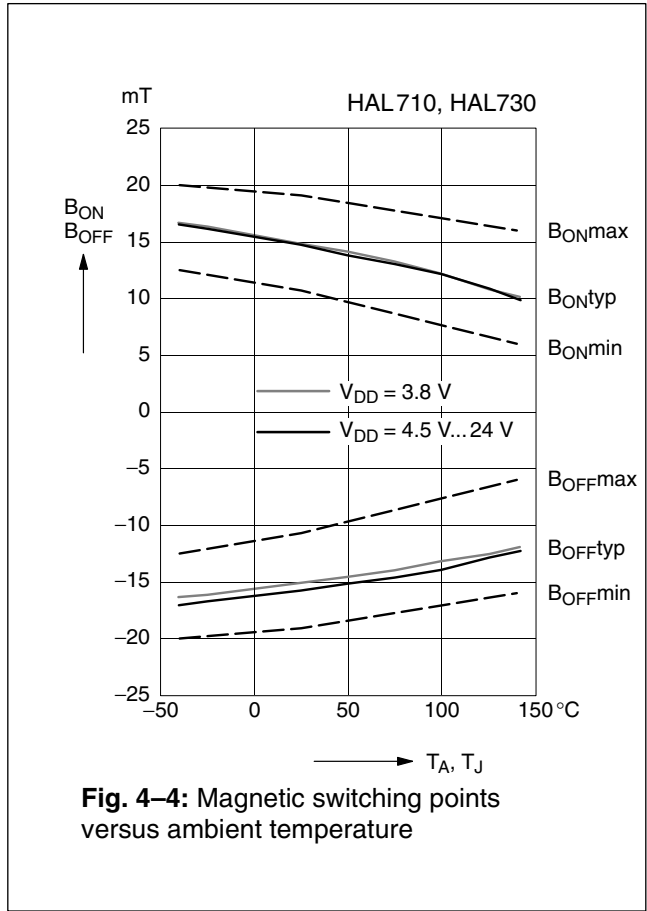
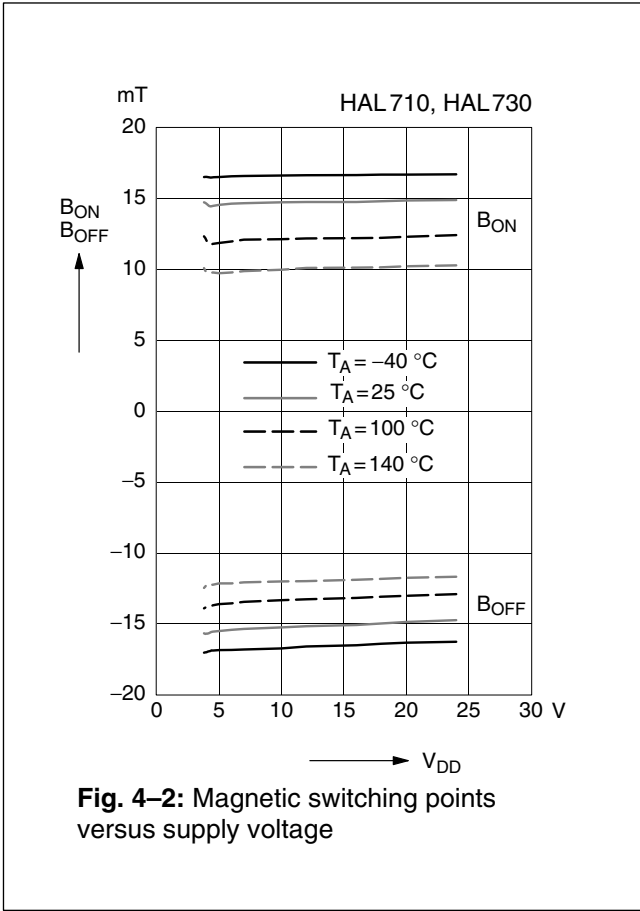

5. Application Notes

5.1. Ambient Temperature

Due to the internal power dissipation, the temperature on the silicon chip (junction temperature T_J) is higher than the temperature outside the package (ambient temperature T_A).

$$T_J = T_A + \Delta T$$

At static conditions and continuous operation, the following equation applies:

$$\Delta T = I_{DD} \times V_{DD} \times R_{th}$$

For typical values, use the typical parameters. For worst case calculation, use the max. parameters for I_{DD} and R_{th} , and the max. value for V_{DD} from the application.

For all sensors, the junction temperature range T_J is specified. The maximum ambient temperature T_{Amax} can be calculated as:

$$T_{Amax} = T_{Jmax} - \Delta T$$

5.2. Extended Operating Conditions

All sensors fulfill the electrical and magnetic characteristics when operated within the Recommended Operating Conditions (see Section 3.5. on page 10).

Supply Voltage Below 3.8 V

Typically, the sensors operate with supply voltages above 3 V, however, below 3.8 V some characteristics may be outside the specification.

Note: The functionality of the sensor below 3.8 V is not tested. For special test conditions, please contact Micronas.

5.3. Signal Delay

The extra circuitry required for the direction detection increases the latency of the Count and Direction Signal compared to a simple switch (e.g., HAL 525). This extra delay corresponds to 0.5 and 1 clock period for the Direction Signal and Count Signal respectively.

5.4. Test Mode Activation

In order to obtain the normal operation as described above, two external pull-up resistors with appropriate values are required to connect each output to an external supply, such that the potential at the open-drain output rises to at least 3 V in less than 10 μ s after having turned off the corresponding pull-down transistor or after having applied V_{DD} .

If the Direction Output is pulled low externally (the potential does not rise after the internal pull-down transistor has been turned off), the device enters Manufacturer Test Mode.

Direction detection is not functional in Manufacturer Test Mode. The device returns to normal operation as soon as the Count Output goes high.

Note: The presence of a Manufacturer Test Mode requires appropriate measures to prevent accidental activation (e.g., in response to EMC events).

5.5. EMC and ESD

For applications that cause disturbances on the supply line or radiated disturbances, a series resistor and a capacitor are recommended (see Fig. 5–1). The series resistor and the capacitor should be placed as closely as possible to the Hall sensor.

Please contact Micronas for detailed investigation reports with EMC and ESD results.

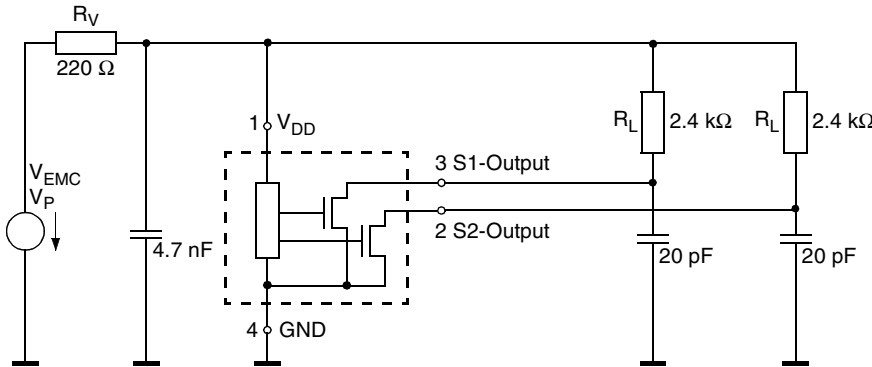

Fig. 5–1: Test circuit for EMC investigations

5.6. Start-up Behavior

Due to the active offset compensation, the sensors have an initialization time (enable time $t_{en(O)}$) after applying the supply voltage. The parameter $t_{en(O)}$ is specified in the “Characteristics” (see Section 3.6. on page 11).

During the initialization time, the output states are not defined and the outputs can toggle. After $t_{en(O)}$, both outputs will be either high or low for a stable magnetic field (no toggling) and the Count Output will be low if the applied magnetic field B exceeds B_{ON} . The Count Output will be high if B drops below B_{OFF} . The Direction Output will have the correct state after the second edge (rising or falling) in the same direction.

The device contains a Power-On Reset circuit (POR) generating a reset when V_{DD} rises. This signal is used to disable Test Mode. The generation of this reset signal is guaranteed when V_{DD} at the chip rises to a minimum 3.8 V in less than 4 μ s monotonically. If this condition is violated, the internal reset signal might be missing. Under these circumstances, the chip will still operate according to the specification, but the risk of toggling outputs during $t_{en(O)}$ increases; and for magnetic fields between B_{OFF} and B_{ON} , the output states of the Hall sensor after applying V_{DD} will be either low or high. In order to achieve a well-defined output state, the applied magnetic field then must exceed B_{ONmax} , respectively, drop below B_{OFFmin} .

6. Data Sheet History

1. Data Sheet: "HAL710, HAL730 Hall-Effect Sensors with Direction Detection", May 13, 2002, 6251-478-1DS. First release of the data sheet.
2. Data Sheet: "HAL710, HAL730 Hall-Effect Sensors with Direction Detection", Sept. 15, 2004, 6251-478-2DS. Second release of the data sheet. Major changes:
 - new package diagram for SOT89B-2
3. Data Sheet: "HAL710, HAL730 Hall-Effect Sensors with Direction Detection", July 31, 2006, 6251-478-3DS. Third release of the data sheet. Major changes:
 - section 5.5 EMC and ESD added
4. Data Sheet: "HAL 710, HAL 730 Hall-Effect Sensors with Direction Detection", Oct.13, 2009, DSH000031_002EN. Fourth release of the data sheet. Major changes:
 - Patents mentioned on disclaimer page updated
 - Section 1.6. on page 5 "Solderability and Welding" updated
 - Package diagram updated