

# FEMALE PLUG M8 STRAIGHT

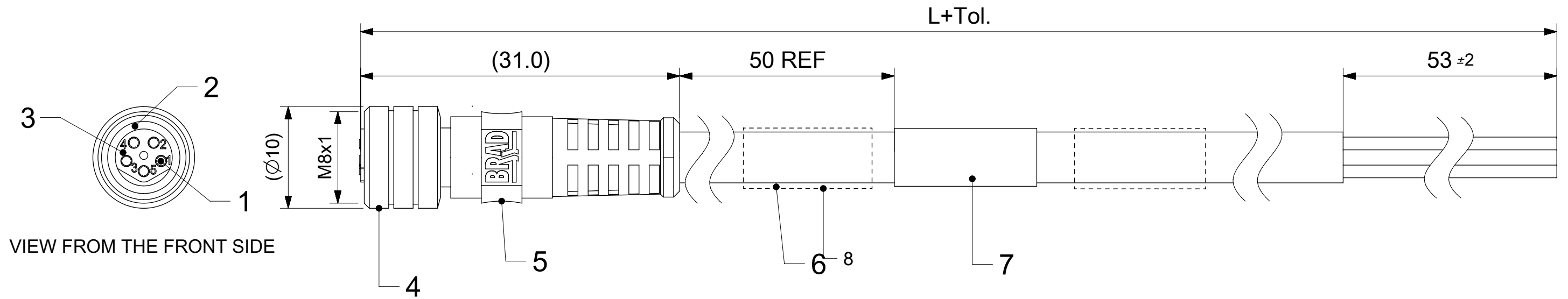

VIEW FROM THE FRONT SIDE

- NOTES:**
- RATED VOLTAGE: 3 contacts 60V AC/DC  
4 and 5 contacts 30V AC/DC
  - CURRENT RATING: 3, 4, 5 contacts 3A
  - PROTECTION CLASS: IP 67
  - TEMPERATURE: -25°C / +80°C

CONTACTS POSITION FRONT VIEW:

	3 CONTACTS		4 CONTACTS		5 CONTACTS	
FEMALE						
CONNECTIONS	PIN	WIRE	PIN	WIRE	PIN	WIRE
	1	BROWN	1	BROWN	1	BROWN
	3	BLUE	2	WHITE	2	WHITE
	4	BLACK	3	BLUE	3	BLUE
			4	BLACK	4	BLACK
					5	GREY

CODING ACCORDING TO IEC 61076-2-104

FOR OPTIONS SEE - NUMERICAL CODE - ON SHEET 2

ITEM	QTY.	DESCRIPTION	MATERIAL	FINISH
8	2	I/D CARRIER (SEE MATRIX)	---	---
7	1	LABEL YELLOW	VINYL	---
	-	PRINTING FOR CABLES Ixx	---	---
6	-	CABLE	SEE SHEET 2	---
5	-	OVERMOULDING BLACK	TPU	---
4	1	COUPLING NUT M8 FEMALE	BRASS	NICKEL
3	1	INSERT FEMALE BLACK	TPU	---
2	1	O-RING RED	FKM	---
1	3 / 4 / 5	CONTACT M8 FEMALE	BRASS	SELECTIVE Au OVER Ni

SYMBOLS	THIS DRAWING CONTAINS INFORMATION THAT IS PROPRIETARY TO MOLEX ELECTRONIC TECHNOLOGIES, LLC AND SHOULD NOT BE USED WITHOUT WRITTEN PERMISSION	CURRENT REV DESC:		<b>molex</b>	
	DIMENSION UNITS: <b>mm</b> SCALE: <b>2:1</b> GENERAL TOLERANCES (UNLESS SPECIFIED) ANGULAR TOL: ± °	EC NO: 600840 DRWN: FDAFERNER 2018/06/29 CHK'D: RSILLER 2018/07/05 APPR: RSILLER 2018/07/05			
▽ = 0 4 PLACES ± ▽ = 0 3 PLACES ± ▽ = 0 2 PLACES ± ▽ = 0 1 PLACE ± ▽ = 0 0 PLACES ± ■ = 0 DRAFT WHERE APPLICABLE MUST REMAIN WITHIN DIMENSIONS	INITIAL REVISION: DRWN: AKONDRACIUK 2017/02/16 APPR: MIWASIECZKO 2017/11/16		PRODUCT CUSTOMER DRAWING		DOCUMENT NUMBER <b>1200860594</b>
THIRD ANGLE PROJECTION 	DRAWING <b>A3-SIZE</b>	SERIES <b>120086</b>	MATERIAL NUMBER SEE SHEET 3-4	CUSTOMER GENERAL MARKET	DOC TYPE DOC PART REVISION PSD 000 <b>A2</b> SHEET NUMBER 1 OF 4

# ENGINEERING NO. - NUMERICAL CODE (Available parts see PART LIST table. Other parts available upon request).

## OPTIONS

4 0 X 0 0 0 X X X X X X X X

40=Nano-Change  
M8x1  
Double ended

Contacts:  
3=3 Contacts  
4=4 Contacts  
5=5 Contacts

Heads style:  
000=Plug Female Straight

Cable type: See Table

Units:  
M=Meter  
C=Centimeter

Length  
Examples:  
005=0.5 unit  
010=1 unit  
100=10 unit

Overmold color:  
Blank (Standard)=Black  
A = Grey / G=Black / Y=Yellow

Coupling Nut:  
Blank (Standard)=Knurled Brass Ni Plated  
9 = Knurled / Hexagonal SW9 Brass Ni Plated

7 = Teflon

H = 2 pcs. of I/D Carrier PVC Transparent  
(Cables lxx & P82 always with 2 pcs. of I/D Carrier)

COUPLING NUT  
FEMALE

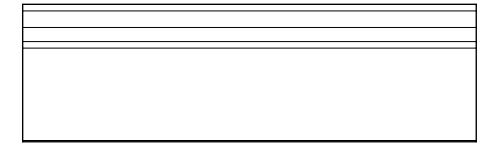
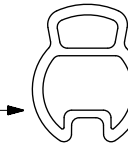
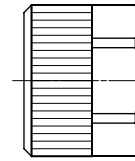
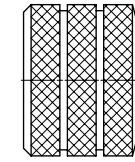

## CABLE INFORMATION (for more information see Cable Data Sheet).

CABLE TYPE	NO. OF WIRES	CROSS SECTION	CABLE JACKET	UL	CSA	STATIC: TEMP. / BENDING RADIUS	DYNAMIC: TEMP. / BENDING RADIUS	DRAG CHAIN	SHIELD
E02	3 / 4 / 5	0.25mm <sup>2</sup>	PVC BLACK	UL 2464/1729	C22.2 I/II A/B 80°C/300V	-30°C to +80°C, >10xO.D.	-10°C to +80°C, >15xO.D.	-	-
E18	3 / 4	0.20mm <sup>2</sup>	PVC YELLOW	-	-	-30°C to +70°C	-5°C to +70°C	-	-
E51	4	0.25mm <sup>2</sup>	PVC GREY	-	-	-	-	-	-
E52	3 / 4 / 8	0.34mm <sup>2</sup>	PVC GREY	-	-	-30°C to +70°C	-5°C to +70°C	-	-
E54	3	0.25mm <sup>2</sup>	PVC GREY	-	-	-25°C to +70°C	-5°C to +70°C	-	-
H08	3 / 4 / 5	0.25mm <sup>2</sup>	PUR BLACK LS0H	UL 21198/10493	C22.2 I/II A/B 80°C/300V	-40°C to +80°C, >5xO.D.	-25°C to +80°C, >10xO.D.	2 000 000 cycles at 20°C, Temp. range +5°C to +60°C	-
H09	3 / 4 / 5	0.34mm <sup>2</sup>	PUR BLACK LS0H	UL 21198/10493	C22.2 I/II A/B 80°C/300V	-40°C to +80°C, >5xO.D.	-25°C to +80°C, >10xO.D.	2 000 000 cycles at 20°C, Temp. range +5°C to +60°C	-
H69	4	0.20mm <sup>2</sup>	PUR GRAY LS0H	-	-	-	-	-	-
I02	3 / 4	0.25mm <sup>2</sup>	PVC CEI GREY	-	-	-30°C to +70°C	-5°C to +70°C	-	-
P02	3 / 4 / 5	0.25mm <sup>2</sup>	PUR / PVC BLACK	-	-	-30°C to +80°C, >7xO.D.	-5°C to +80°C, >15xO.D.	-	-
P03	3 / 4 / 5	0.34mm <sup>2</sup>	PUR / PVC BLACK	-	-	-30°C to +80°C, >7xO.D.	-5°C to +80°C, >15xO.D.	-	-
P18	4	0.20mm <sup>2</sup>	PUR YELLOW	-	-	-	-	-	-
P82	3	0.34mm <sup>2</sup>	PUR IRR ORANGE	-	-	-50°C to +105°C, >5xO.D.	-40°C to +105°C, >7.5xO.D.	-	-
K05	3 / 4 / 5	0.34mm <sup>2</sup>	TPE YELLOW	UL ITC E195601 or PLC	I/II A/B 90°C/300V	-	-	-	-
L03	3	0.34mm <sup>2</sup>	Blend PUR ORANGE	-	-	-30°C to +90°C	-5°C to +90°C	-	-
A10	3 / 4 / 5	0.25mm <sup>2</sup>	PVC YELLOW	UL 2661	I/II A/B 105°C/300V	-	-	-	-

## CABLE LENGTH TOLERANCES

OVER	UP TO AND INCLUDING	TOLERANCES
0	305mm	+19mm
305mm	915mm	+45mm
915mm	1830mm	+56mm
1830mm	3660mm	+89mm
3660mm	7320mm	+165mm
7320mm	14640mm	+317mm
14640mm	30500mm	+610mm
30500mm	>	+2% of finished length

SYMBOLS	THIS DRAWING CONTAINS INFORMATION THAT IS PROPRIETARY TO MOLEX ELECTRONIC TECHNOLOGIES, LLC AND SHOULD NOT BE USED WITHOUT WRITTEN PERMISSION		CURRENT REV DESC:		molex	
▽ = 0	DIMENSION UNITS	SCALE	EC NO: 600840		M8 SINGLE ENDED FEMALE STRAIGHT	
▽ = 0	mm	2:1	DRWN: FDAFERNER 2018/06/29		PRODUCT CUSTOMER DRAWING	
▽ = 0	GENERAL TOLERANCES (UNLESS SPECIFIED)		CHK'D: RSILLER 2018/07/05		DOCUMENT NUMBER	
▽ = 0	ANGULAR TOL ± °		APPR: RSILLER 2018/07/05		1200860594	
▽ = 0	4 PLACES ±		INITIAL REVISION:		DOC TYPE DOC PART REVISION	
▽ = 0	3 PLACES ±		DRWN: AKONDRACIUK 2017/02/16		PSD 000 A2	
▽ = 0	2 PLACES ±		APPR: MIWASIECZKO 2017/11/16		SHEET NUMBER	
▽ = 0	1 PLACE ±		THIRD ANGLE PROJECTION		SEE SHEET 3-4	
▽ = 0	0 PLACES ±		DRAWING		GENERAL MARKET	
▽ = 0	DRAFT WHERE APPLICABLE MUST REMAIN WITHIN DIMENSIONS		SERIES		2 OF 4	
▽ = 0			A3-SIZE			
▽ = 0			120086			
▽ = 0			MATERIAL NUMBER			
▽ = 0			CUSTOMER			

# PART LIST

Pos.	Part. No	Engineering No.	Cable Length
1	1200270066	403000E02M020	2m
2	1200270067	403000E02M030	3m
3	1200270068	403000E02M050	5m
4	1200270070	403000E02M100	10m
5	1200270127	404000E02M020	2m
6	1200270129	404000E02M050	5m
7	1200270131	404000E02M100	10m
8	1200270132	404000E02M150	15m
9	1200270133	404000E02M200	20m
10	1200270400	403000E02M010	1m
11	1200270549	404000E02M010	1m
12	1200271410	403000E02M012	1.2m
13	1200271417	403000E02M006	0.6m
14	1200271418	403000E02M015	1.5m
15	1200271419	403000E02M025	2.5m
16	1200271423	404000E02M005	0.5m
17	1200865038	403000E02M250	25m
18	1200868015	403000E02M200	20m
19	1200868067	404000E02M050G	5m
20	1200868068	404000E02M100G	10m
21	1200868069	404000E02M200G	20m
22	1200868070	404000E02M300G	30m
23	1200868071	404000E02M400G	40m
24	1200868072	404000E02M500G	50m
25	1200868073	404000E02M700G	70m
26	1200868074	404000E02M1K0G	100m
27	1200868075	404000E02M020G	2m
28	1200868090	403000E02M150	15m
29	1200868099	405000E02M020	2m
30	1200868109	403000E02M100G	10m
31	1200868114	404000E02M030	3m
32	1200868151	405000E02M040	4m
33	1200868171	405000E02M050	5m
34	1200868172	405000E02M100	10m
35	1200868262	403000E02M002	0.2m

Pos.	Part. No	Engineering No.	Cable Length
36	1200868263	403000E02M003	0.3m
37	1200868264	403000E02M020H	2m
38	1200868265	403000E02M035	3.5m
39	1200868266	403000E02M045	4.5m
40	1200868267	403000E02M0501	5m
41	1200868268	403000E02M060	6m
42	1200868339	404000E02C200	2m
43	1200868340	404000E02M015	1.5m
44	1200868341	404000E02M0201	2m
45	1200868342	404000E02M040	4m
46	1200868343	404000E02M0501	5m
47	1200868344	404000E02M080	8m
48	1200868345	404000E02M110	11m
49	1200868346	404000E02M170	17m
50	1200868347	404000E02M210	21m
51	1200868348	404000E02M250	25m
52	1200868423	403000E02M1001	10m
53	1200868442	403000E02M020Y	2m
54	1200868443	403000E02M050Y	5m
55	1200868444	403000E02M100Y	10m
56	1200868452	404000E02M050Y	5m
57	1200868453	404000E02M100Y	10m
58	1200868454	404000E02M150Y	15m
59	1200868467	403000E02M150Y	15m
60	1200868473	404000E02M1001	10m
61	1200868508	404000E02M050H	5m
62	1200868509	404000E02M100H	10m
63	1200868510	404000E02M150H	15m
64	1200868511	404000E02M030H	3m
65	1200868518	404000E02C230	2.3m
66	1200868571	405000E02M120	12m
67	1200868572	405000E02M030	3m
68	1200868685	403000E02M050H	5m
69	1200868696	404000E02M0509H	5m
70	1200868697	404000E02M1009H	10m

Pos.	Part. No	Engineering No.	Cable Length
71	1200868698	404000E02M1509H	15m
72	1200868774	404000E02M060	6m
73	1200868776	404000E02M070	7m
74	1200271409	403000H08M010	1m
75	1200271442	403000H08M020G	2m
76	1200868045	403000H08M020	2m
77	1200868053	404000H08M050	5m
78	1200868060	404000H08M030	3m
79	1200868101	403000H08M050	5m
80	1200868115	403000H08M100	10m
81	1200868116	403000H08M200	20m
82	1200868117	404000H08M100	10m
83	1200868118	404000H08M200	20m
84	1200868122	403000H08M030	3m
85	1200868162	404000H08M040	4m
86	1200868207	404000H08M020	2m
87	1200868209	403000H08M015	1.5m
88	1200868214	403000H08M005	0.5m
89	1200868215	404000H08M005	0.5m
90	1200868395	405000H08M020	2m
91	1200868404	405000H08M050	5m
92	1200868405	405000H08M100	10m
93	1200868468	403000H08M050Y	5m
94	1200868469	403000H08M100Y	10m
95	1200868487	404000H08M010	1m
96	1200868596	403000H08M010Y	1m
97	1200868476	403000H09M020	2m
98	1200860468	403000P03M050GQ	5m
99	1200868030	404000P03M200G	20m
100	1200270709	405000P02M020	2m
101	1200270854	405000P02M075G	7.5m
102	1200860475	405000P02M050	5m
103	1200860594	405000P02M100	10m
104	1200868001	403000P02M020	2m
105	1200868002	403000P02M050	5m

Pos.	Part. No	Engineering No.	Cable Length
106	1200868003	403000P02M100	10m
107	1200868148	405000P02M005	0.5m
108	1200868156	404000P02M020	2m
109	1200868157	404000P02M050	5m
110	1200868158	404000P02M100	10m
111	1200868274	403000P02C350	3.5m
112	1200868275	403000P02M002	0.2m
113	1200868276	403000P02M002G	0.2m
114	1200868277	403000P02M003	0.3m
115	1200868278	403000P02M003G	0.3m
116	1200868279	403000P02M005	0.5m
117	1200868280	403000P02M006	0.6m
118	1200868281	403000P02M010	1m
119	1200868282	403000P02M012	1.2m
120	1200868283	403000P02M018	1.8m
121	1200868284	403000P02M022	2.2m
122	1200868285	403000P02M030	3m
123	1200868286	403000P02M032	3.2m
124	1200868287	403000P02M035	3.5m
125	1200868288	403000P02M040	4m
126	1200868289	403000P02M050G	5m
127	1200868290	403000P02M055	5.5m
128	1200868291	403000P02M080	8m
129	1200868292	403000P02M150	15m
130	1200868351	404000P02M003	0.3m
131	1200868352	404000P02M030	3m
132	1200868353	404000P02M040	4m
133	1200868354	404000P02M070	7m
134	1200868355	404000P02M500	50m
135	1200868517	403000P02M200	20m
136	1200868530	404000P02M010	1m
137	1200868627	405000P02M050Y	5m
138	1200868773	404000P02M060	6m
139	1200868775	404000P02M200	20m
140	1200270637	403000E52M050G	5m









<b>SYMBOLS</b> = 0 = 0 = 0 = 0 = 0 = 0 = 0 = 0	THIS DRAWING CONTAINS INFORMATION THAT IS PROPRIETARY TO MOLEX ELECTRONIC TECHNOLOGIES, LLC AND SHOULD NOT BE USED WITHOUT WRITTEN PERMISSION DIMENSION UNITS: <b>mm</b> SCALE: <b>2:1</b>	CURRENT REV DESC:  EC NO: 600840 DRWN: FDAFERNER 2018/06/29 CHK'D: RSILLER 2018/07/05 APPR: RSILLER 2018/07/05  INITIAL REVISION: DRWN: AKONDRACIUK 2017/02/16 APPR: MIWASIECZKO 2017/11/16	<b>molex</b>		
	GENERAL TOLERANCES (UNLESS SPECIFIED) ANGULAR TOL ± ° 4 PLACES ± 3 PLACES ± 2 PLACES ± 1 PLACE ± 0 PLACES ±		M8 SINGLE ENDED FEMALE STRAIGHT		
	DRAFT WHERE APPLICABLE MUST REMAIN WITHIN DIMENSIONS THIRD ANGLE PROJECTION DRAWING: SERIES: <b>A3-SIZE</b> MATERIAL NUMBER: <b>120086</b> CUSTOMER: <b>SEE PART LIST</b> SHEET NUMBER: <b>3 OF 4</b>		PRODUCT CUSTOMER DRAWING		
			DOCUMENT NUMBER: <b>1200860594</b> DOC TYPE: <b>PSD</b> DOC PART: <b>000</b> REVISION: <b>A2</b>		

# PART LIST

Pos.	Part. No	Engineering No	Cable Length
141	1200860340	403000K05M050	5m
142	1200868431	403000K05M150	15m
143	1200270642	403000L03M005A	0.5m
144	1200270080	403000I02M003	0.3m
145	1200270081	403000I02M020	2m
146	1200270082	403000I02M030	3m
147	1200270083	403000I02M050	5m
148	1200270084	403000I02M100	10m
149	1200270148	404000I02M020	2m
150	1200270149	404000I02M050	5m
151	1200270360	404000I02M100	10m
152	1200860041	404000I02M030	3m
153	1200868269	403000I02M005	0.5m
154	1200868270	403000I02M006	0.6m
155	1200868271	403000I02M010	1m
156	1200868272	403000I02M025	2.5m
157	1200868273	403000I02M150	15m
158	1200868349	404000I02M003	0.3m
159	1200868350	404000I02M050G	5m
160	1200868445	403000I02M030Y	3m
161	1200868446	403000I02M050Y	5m
162	1200868447	403000I02M100Y	10m
163	1200868455	404000I02M020Y	2m
164	1200868456	404000I02M050Y	5m
165	1200868460	404000I02M100Y	10m
166	1200868507	403000I02M020Y	2m
167	1200868566	404000I02M030Y	3m
168	1200270147	404000H69M020	2m
169	1200868100	404000H69M100	10m
170	1200868184	404000H69M010	1m
171	1200270445	404000H69M050	5m
172	1200271440	403000H69M050	5m
173	1200271441	403000H69M020	2m
174	1200270032	403000P82M050	5m
175	1200271042	404000P82M0207	2m

Pos.	Part. No	Engineering No	Cable Length
176	1200271180	403000P82M020	2m
177	1200271305	404000P82M050	5m
178	1200271450	404000P82M0507	5m
179	1200868183	403000P82M0507	5m
180	1200868192	403000P82M0207	2m
181	1200868212	403000P82M005	0.5m
182	1200868213	404000P82M005	0.5m
183	1200868232	404000P82M010	1m
184	1200868233	403000P82M010	1m
185	1200868420	403000P82M1007	10m
186	1200868461	404000P82M0207Y	2m
187	1200868470	403000P82M0207Y	2m
188	1200868481	404000P82M010Y	1m
189	1200868482	403000P82M010Y	1m
190	1200868567	404000P82M0307Y	3m
191	1200868602	404000P82M050Y	5m
192	1200270341	404000P18M050	5m
193	1200270346	404000P18M100	10m
194	1200270863	404000P18M005	0.5m
195	1200271449	403000P18M070	7m
196	1200860101	403000A10M015	1.5m
197	1200860102	403000A10M020	2m
198	1200860107	403000A10M050	5m
199	1200860111	403000A10M100	10m
200	1200860112	403000A10M150	15m
201	1200860144	404000A10M020	2m
202	1200860145	404000A10M030	3m
203	1200860147	404000A10M050	5m
204	1200860155	404000A10M100	10m
205	1200860191	405000A10M020	2m
206	1200270140	404000E18M050	5m
207	1200270581	403000E18M020	2m
208	1200270606	403000E18M100	10m
209	1200868017	403000E18M050	5m
210	1200868028	404000E18M020	2m

Pos.	Part. No	Engineering No	Cable Length
211	1200868029	404000E18M030	3m
212	1200270078	403000E54M050A	5m
213	1200868018	403000E54M030A	3m
214	1200270143	404000E51M020A	2m
215	1200270145	404000E51M050A	5m
216	1200868666	405000B41M100	10m
217	1200868659	404000B41M010	1m
218	1200868656	403000B41M020	2m
219	1200868657	403000B41M050	5m
220	1200868658	403000B41M100	10m
221	1200860667	405000P02M200	20m
222	1200868849	405000H08M010	1m
223	1200868857	405000E02M010	1m
224			
225			
226			
227			
228			
229			
230			
231			
232			
233			
234			
235			
236			
237			
238			
239			
240			
241			
242			
243			
244			
245			

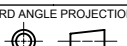
<b>SYMBOLS</b>  = 0  = 0  = 0  = 0  = 0  = 0  = 0  = 0	THIS DRAWING CONTAINS INFORMATION THAT IS PROPRIETARY TO MOLEX ELECTRONIC TECHNOLOGIES, LLC AND SHOULD NOT BE USED WITHOUT WRITTEN PERMISSION DIMENSION UNITS: <b>mm</b> SCALE: <b>1:1</b>		CURRENT REV DESC: EC NO: 600840 DRWN: FDAFERNER    2018/06/29 CHK'D: RSILLER    2018/07/05 APPR: RSILLER    2018/07/05		 M8 SINGLE ENDED FEMALE STRAIGHT			
	GENERAL TOLERANCES (UNLESS SPECIFIED) ANGULAR TOL ± °		INITIAL REVISION: DRWN: AKONDRACIUK    2017/02/16 APPR: MIWASIECZKO    2017/11/16				PRODUCT CUSTOMER DRAWING	
	4 PLACES ± 3 PLACES ± 2 PLACES ± 1 PLACE ± 0 PLACES ±		DRAFT WHERE APPLICABLE MUST REMAIN WITHIN DIMENSIONS		THIRDS ANGLE PROJECTION: 		DOCUMENT NUMBER: <b>1200860594</b> DOC TYPE: PSD    DOC PART: 000    REVISION: A2	
			DRAWING: <b>A3-SIZE</b> SERIES: <b>120086</b>		MATERIAL NUMBER: SEE PART LIST    CUSTOMER: GENERAL MARKET		SHEET NUMBER: <b>4 OF 4</b>	

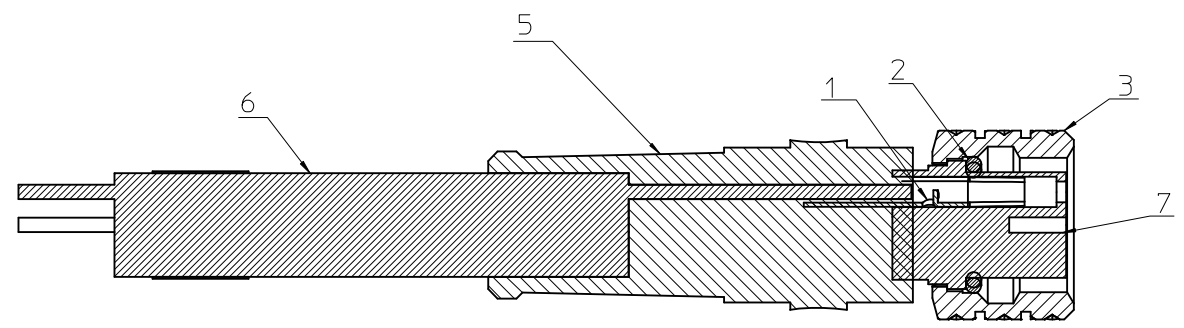
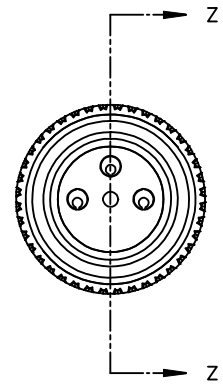
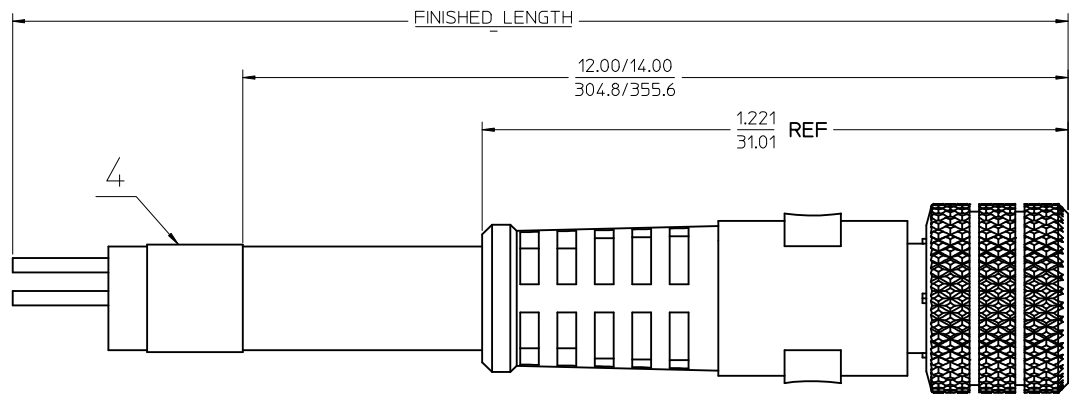
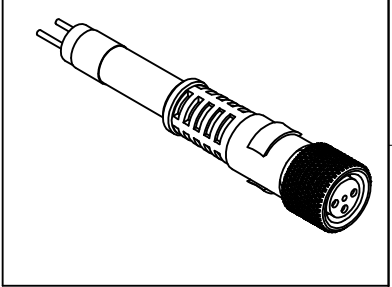

Section Z-Z

FEMALE INSERT FRONT VIEW		
3 POLE	4 POLE	5 POLE
1 BROWN 3 BLUE 4 BLACK	1 BROWN 2 WHITE 3 BLUE 4 BLACK	1 BROWN 2 WHITE 3 BLUE 4 BLACK 5 GREY

ENTER DESCRIPTION EC NO: MNA2009-0804 DRAWN BY: DRWINAKUMAR01 2009/06/30 CHKD: JFMURPHY APPR: JFMURPHY 2009/07/08 REV: A	DESCRIPTION QUALITY SYMBOLS ▽=0 ▽=0
---	--

GENERAL TOLERANCES (UNLESS SPECIFIED) 4 PLACES ± --- ± --- 3 PLACES ± --- ± --- 2 PLACES ± --- ± --- 1 PLACE ± --- ± --- ANGULAR ±1/2° DRAFT WHERE APPLICABLE MUST REMAIN WITHIN DIMENSIONS
---

DIMENSION STYLE IN/MM DRAWN BY: NKUMAR01 CHECKED BY: BWOODMAN APPROVED BY: JFMURPHY MATERIAL NO. SEE SHEET 2	DATE: 30/06/09 DATE: 30/06/09 DATE: 30/06/09
--	--

SCALE: 5:1 DESIGN UNITS: INCH THIRD ANGLE PROJECTION	TITLE: NC 3P FP 2M COUPLER 24AWG PVC MOLEX INCORPORATED DOCUMENT NO. SD-120086-102 SHEET NO. 1 OF 2
THIS DRAWING CONTAINS INFORMATION THAT IS PROPRIETARY TO MOLEX INCORPORATED AND SHOULD NOT BE USED WITHOUT WRITTEN PERMISSION	

				ASSEMBLY		
				3 POLE	4 POLE	5 POLE
SL.No	DESCRIPTION	MATERIAL	FINISH	QTY		
1	CONTACT SOCKET	COPPER ALLOY	GOLD PLATED	3	4	5
2	O-RING	VITON	RED	1	1	1
3	COUPLING NUT	BRASS	NICKEL PLATED			
4	LABEL	PLASTIC FILM	BLACK/YELLOW			
5	OVER MOLD	TPE	YELLOW			
6	CABLE, 24 AWG, 3 CONDUCTOR	PVC JACKET	YELLOW	1		
	CABLE, 24 AWG, 4 CONDUCTOR	PVC JACKET	YELLOW		1	
	CABLE, 24 AWG, 5 CONDUCTOR	PVC JACKET	YELLOW			1
7	INSERT FEMALE 3 POLE	PUR	BLACK	1		
	INSERT FEMALE 4 POLE	PUR	BLACK		1	
	INSERT FEMALE 5 POLE	PUR	BLACK			1

PART NUMBER	DESCRIPTION	FINISHED LENGTH
1200860102	403000A10M020	2M +90MM -0 [6' 6" +3.5" -0]
1200860106	403000A10M040	4M +150MM -0 [13' 1" +6" -0]
1200860107	403000A10M050	5M +150MM -0 [16' 4" +6" -0]
1200860108	403000A10M060	6M +150MM -0 [19' 7" +6" -0]
1200860111	403000A10M100	10M +300MM -0 [32' 4" +12" -0]
1200860144	404000A10M020	2M +90MM -0 [6' 6" +3.5" -0]
1200860146	404000A10M040	4M +150MM -0 [13' 1" +6" -0]
1200860147	404000A10M050	5M +150MM -0 [16' 4" +6" -0]
1200860148	404000A10M060	6M +150MM -0 [19' 7" +6" -0]
1200860155	404000A10M100	10M +300MM -0 [32' 4" +12" -0]
1200860191	405000A10M020	2M +90MM -0 [6' 6" +3.5" -0]
1200860192	405000A10M040	4M +150MM -0 [13' 1" +6" -0]
1200860193	405000A10M050	5M +150MM -0 [16' 4" +6" -0]
1200860578	405000A10M060	6M +150MM -0 [19' 7" +6" -0]
1200860194	405000A10M100	10M +300MM -0 [32' 4" +12" -0]

<b>ENTER DESCRIPTION</b> EC NO: MNA2009-0804 DRWN: NKUMAR01 2009/06/30 CHKD: APPR: JFMURPHY 2009/07/09 REV: A	QUALITY SYMBOLS =0 =0	GENERAL TOLERANCES (UNLESS SPECIFIED)		DIMENSION STYLE IN/MM	SCALE 5:1	DESIGN UNITS INCH	THIRD ANGLE PROJECTION		
		4 PLACES ± --- ± --- 3 PLACES ± --- ± --- 2 PLACES ± --- ± --- 1 PLACE ± --- ± ---	mm INCH ± --- ± --- ± --- ± --- ± --- ± --- ± --- ± ---	DRAWN BY NKUMAR01	DATE 30/06/09	TITLE NC 3P FP 2M COUPLER 24AWG PVC			
		ANGULAR ±1/2°		CHECKED BY BWOODMAN	DATE 30/06/09	MOLEX INCORPORATED			
		DRAFT WHERE APPLICABLE MUST REMAIN WITHIN DIMENSIONS		APPROVED BY JFMURPHY	DATE 30/06/09	MATERIAL NO. SEE CHART	DOCUMENT NO. SD-120086-102	SHEET NO. 2 OF 2	

THIS DRAWING CONTAINS INFORMATION THAT IS PROPRIETARY TO MOLEX INCORPORATED AND SHOULD NOT BE USED WITHOUT WRITTEN PERMISSION