

THIS DRAWING IS UNPUBLISHED. RELEASED FOR PUBLICATION  
 © COPYRIGHT - BY TYCO ELECTRONICS CORPORATION. ALL RIGHTS RESERVED.

LOC	DIST	REVISIONS			
P	LTR	DESCRIPTION	DATE	DWN	APVD
H	-	A	DRAWING RELEASED PER ECR-11-017294	22AUG2011	JvdH TdB
		B	REVISED PER ECR-15-016753	24NOV2015	FL FY

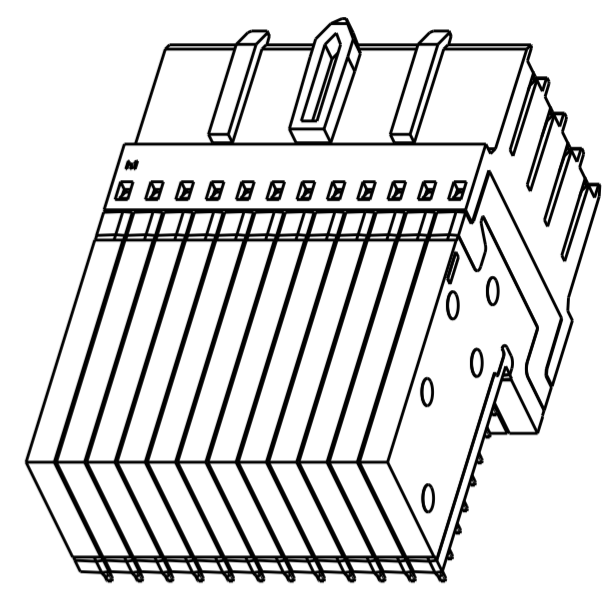

SCALE 3:1

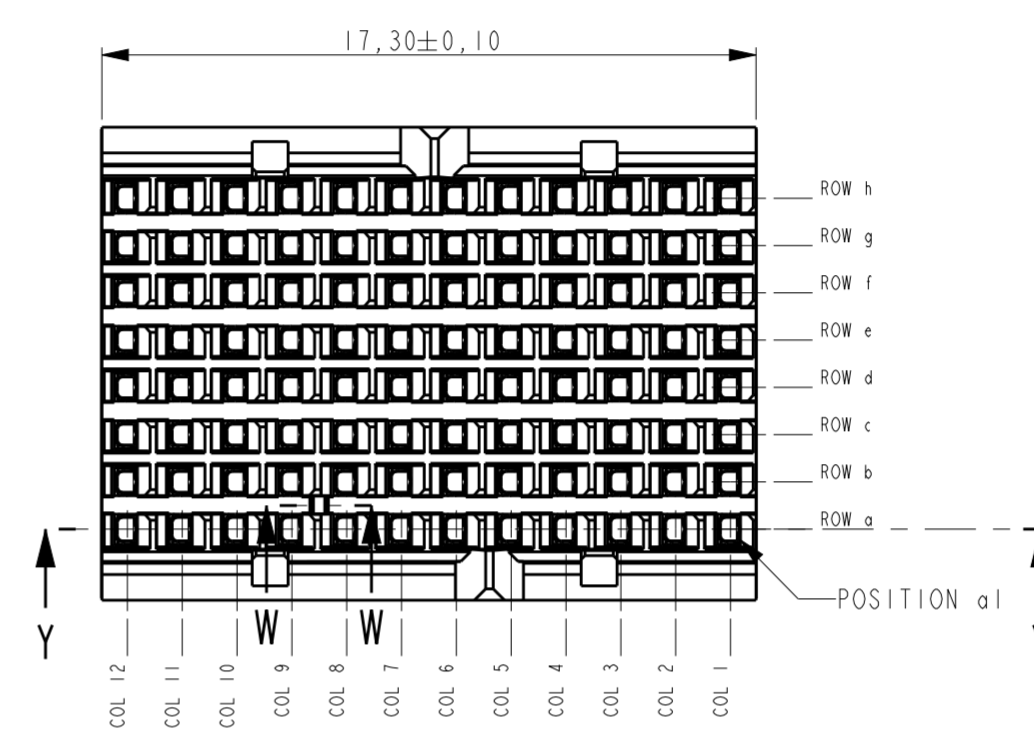
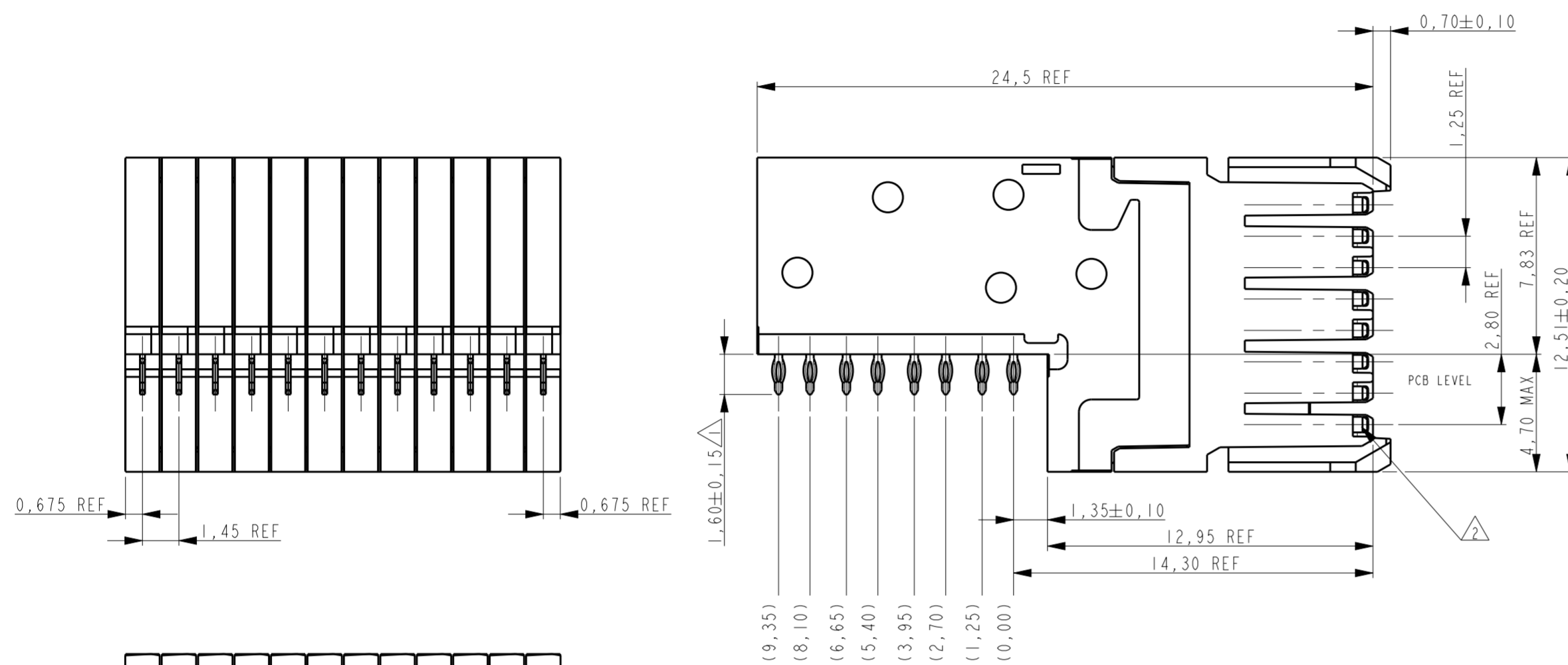
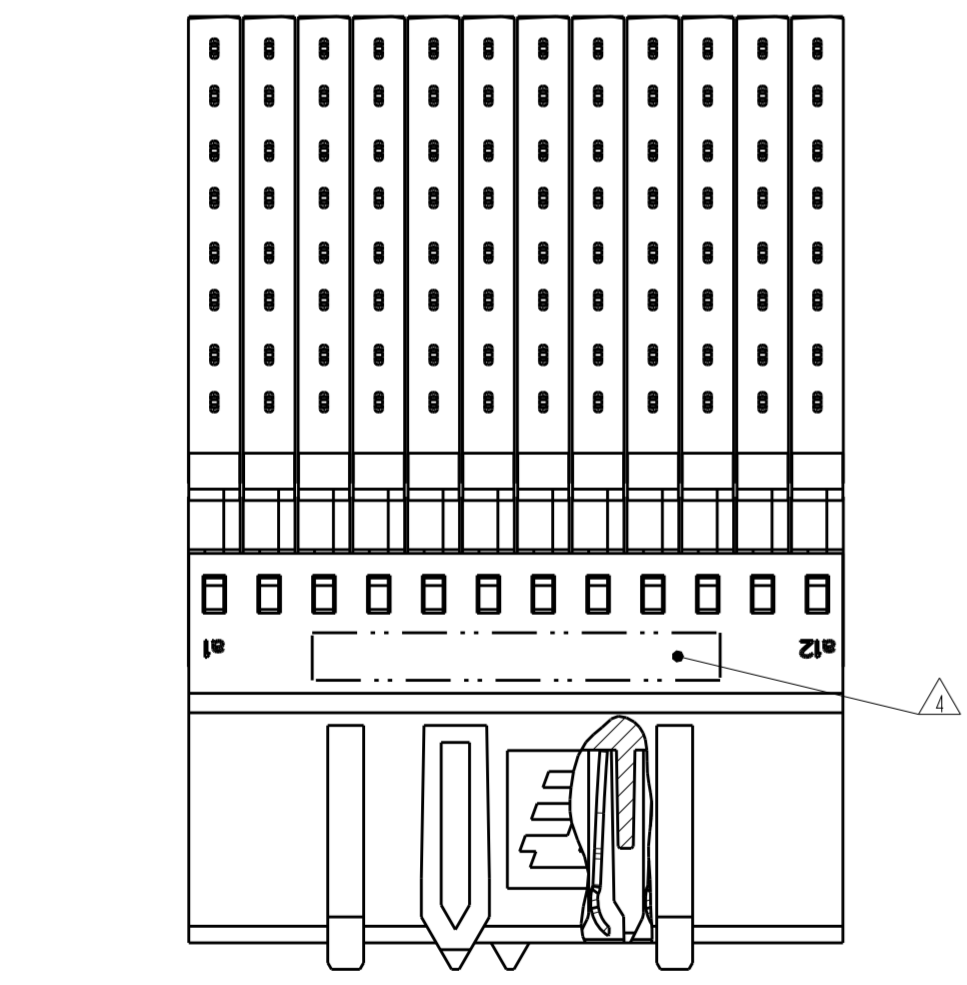

SECTION W-W  
(KEY POSITION)

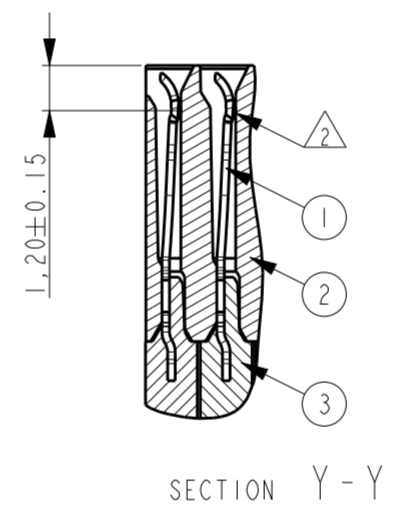

SECTION Y-Y

NOTES:

- 1 PLATING: 0,5µm MIN. TIN OVER NICKEL.
- 2 PLATING:

PARTNUMBER	PERFORMANCE LEVEL
1857657-1	PERFORMANCE LEVEL 1: CONNECTOR TESTED AND QUALIFIED AGAINST TELCORDIA GR-1217-CORE QUALITY LEVEL III: UNCONTROLLED ENVIRONMENT APPLICATIONS. SEE PRODUCT SPEC 108-19353
1857657-2	PERFORMANCE LEVEL 2: CONFORMS TO ALL TESTING ACCORDING PRODUCT SPEC 108-19320, -250 MATING CYCLES, 4 DAYS MIXED GAS TEST PER IEC 60068-2-60 METHOD 1

- 3 CONSULT APPLICATION SPEC OR CONTACT TE CONNECTIVITY FOR PERMISSIBLE CONTACT ASSIGNMENTS.
- 4 CONNECTOR MARKED WITH PARTNUMBER AND DATE CODE. DATE CODE DEFINITION: YYWW.

3	OVERMOLD	LCP 30% GF NATURAL
2	HOUSING	LCP 30% GF NATURAL
1	CONTACT	COPPER ALLOY
ITEM NO.	DESCRIPTION	MATERIAL

THIS DRAWING IS A CONTROLLED DOCUMENT.		DWN J.V.D. HEIJDEN 30 OCT 2006	TE Connectivity <b>FEMALE CONNECTOR</b> <b>Z-PACK Slim UHD High Speed</b>		
DIMENSIONS: mm		CHK J. TUIN 30 OCT 2006			NAME
TOLERANCES UNLESS OTHERWISE SPECIFIED:		APVD J. BROEKSTEEG 30 OCT 2006			SIZE
0 PLC ± 1 PLC ± 2 PLC ± 3 PLC ± 4 PLC ± ANGLES ± FINISH ±		PRODUCT SPEC SEE NOTE 1			CAGE CODE
MATERIAL		APPLICATION SPEC 114-19106	DRAWING NO	RESTRICTED TO	
		WEIGHT	A2 00779 C-1857657		
CUSTOMER DRAWING		SCALE 5:1	SHEET 1 OF 2	REV B	

THIS DRAWING IS UNPUBLISHED. RELEASED FOR PUBLICATION  
 © COPYRIGHT - BY TYCO ELECTRONICS CORPORATION. ALL RIGHTS RESERVED.

LOC	DIST	REVISIONS			
P	LTR	DESCRIPTION	DATE	DWN	APVD
H	-	SEE SHEET 1	-	-	-

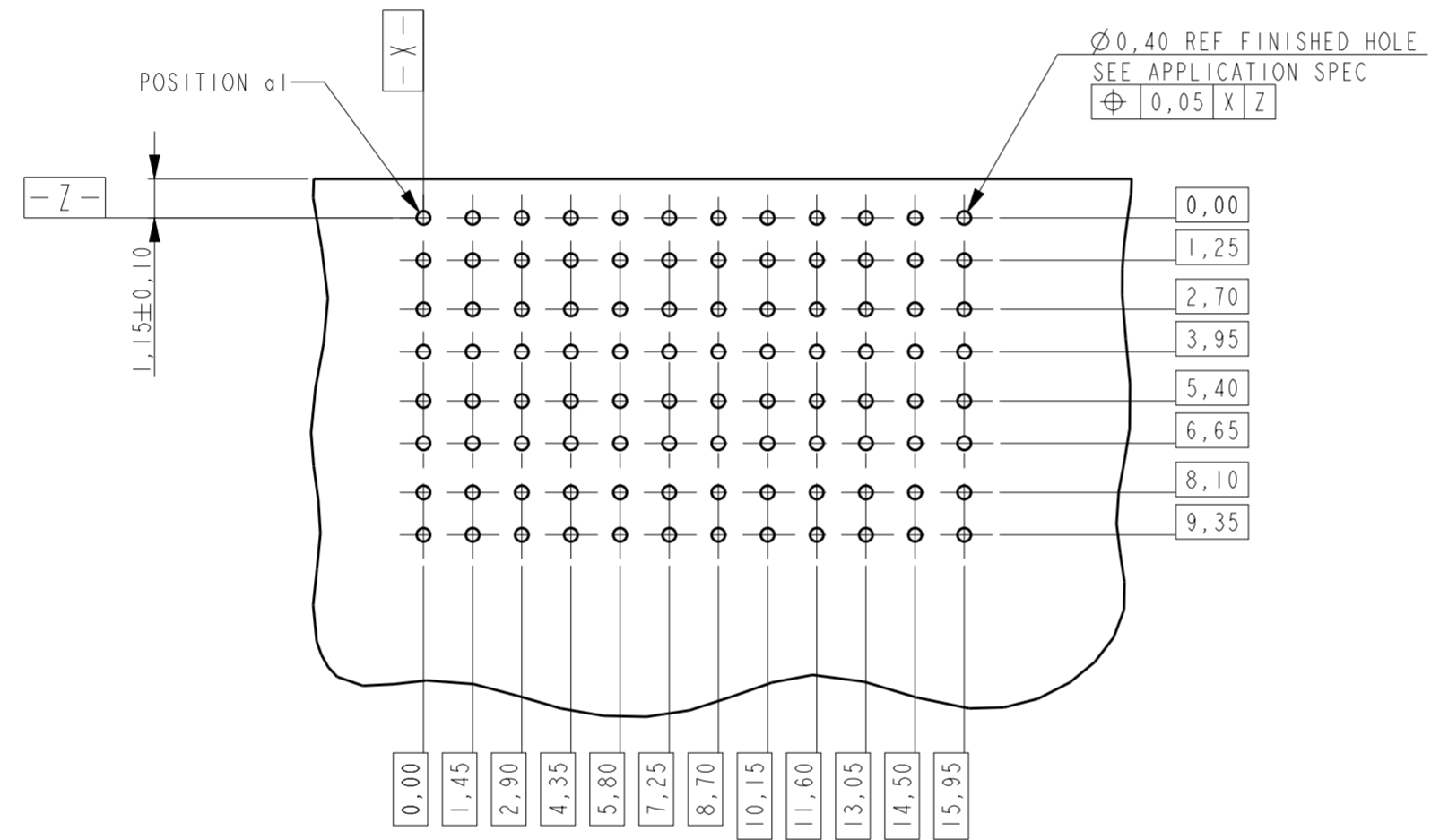

BOARD THICKNESS 1,2 MIN

RECOMMENDED PCB LAYOUT  
(COMPONENT SIDE SHOWN)

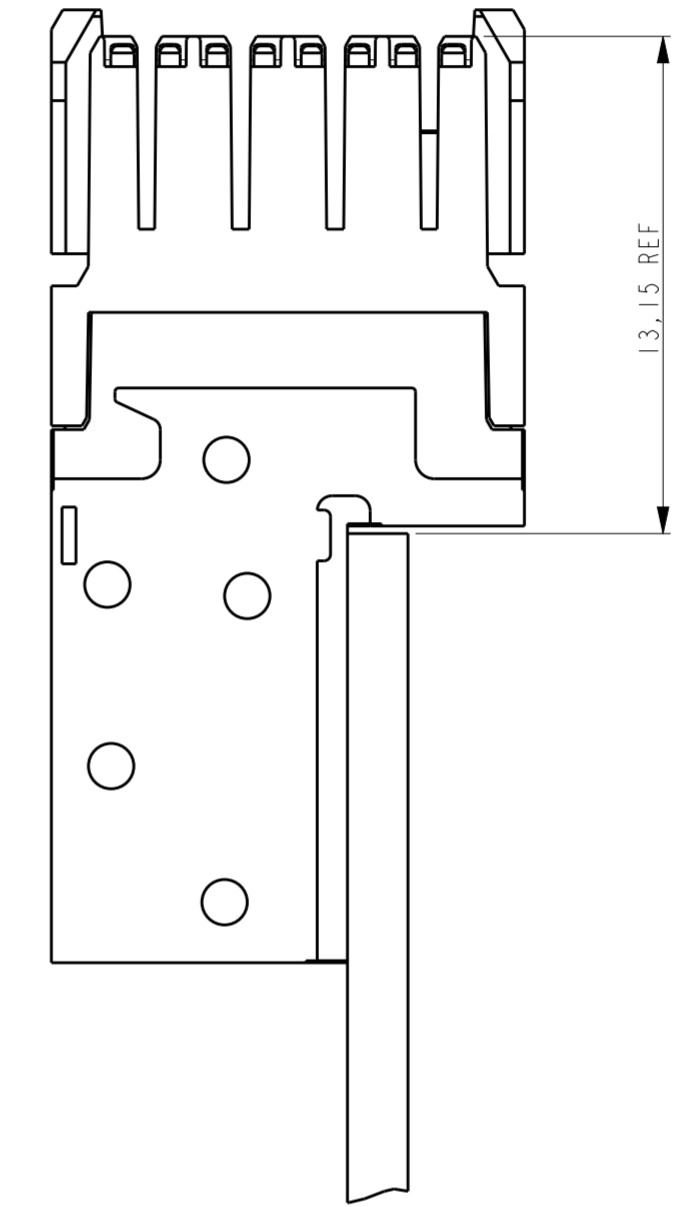

PRODUCT HAS NOT COMPLETED  
QUALIFICATION TESTING

THIS DRAWING IS A CONTROLLED DOCUMENT.		DWN J.V.D. HEIJDEN 30 OCT 2006	TE Connectivity	
DIMENSIONS: mm		CHK J.TWIN 30 OCT 2006		
TOLERANCES UNLESS OTHERWISE SPECIFIED:		APVD J.BROEKSTEEG 30 OCT 2006	NAME FEMALE CONNECTOR Z-PACK Slim UHD High Speed	
0 PLC ± 1 PLC ± 2 PLC ± 3 PLC ± 4 PLC ± ANGLES ± FINISH		PRODUCT SPEC SEE SHEET 1	RESTRICTED TO	
MATERIAL		APPLICATION SPEC SEE SHEET 1	SIZE A2	CAGE CODE 00779
		WEIGHT -	DRAWING NO C-1857657	
		CUSTOMER DRAWING	SCALE 5:1	SHEET 2 OF 2
			REV A	