

CAVITY No.

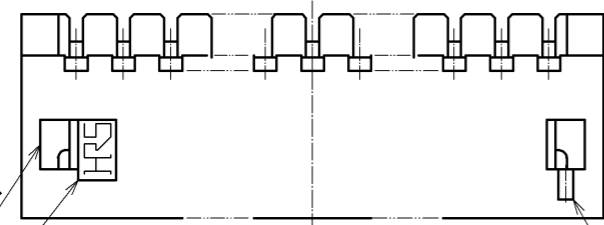
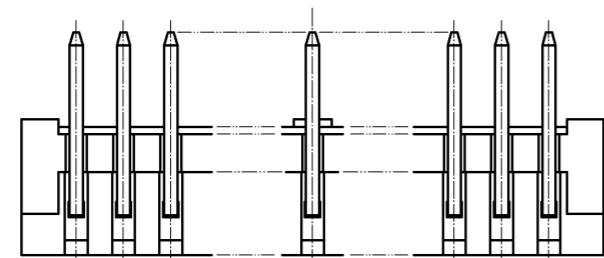
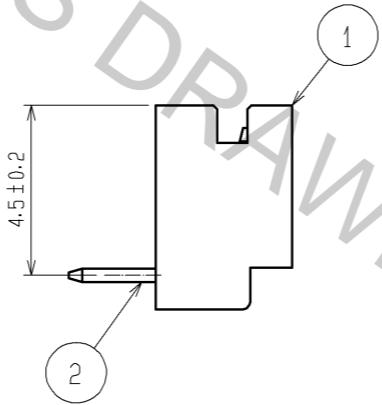
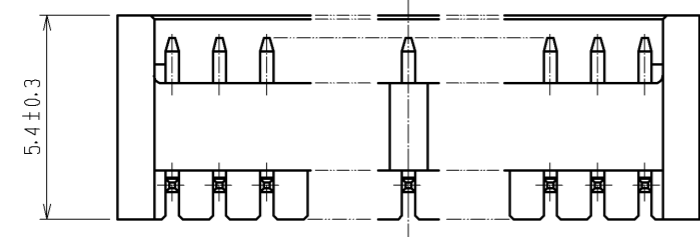

HRS MARKING

POLARIZATION MARKING

PART No.	CODE No.	NUMBER OF CONTACTS	A	B	C
DF13- 2P-1.25DS(50)	CL536-0151-7-50	2	1.25	3.15	4.15
DF13- 3P-1.25DS(50)	CL536-0152-0-50	3	2.50	4.40	5.40
DF13- 4P-1.25DS(50)	CL536-0153-2-50	4	3.75	5.65	6.65
DF13- 5P-1.25DS(50)	CL536-0154-5-50	5	5.00	6.90	7.90
DF13- 6P-1.25DS(50)	CL536-0155-8-50	6	6.25	8.15	9.15
DF13- 7P-1.25DS(50)	CL536-0156-0-50	7	7.50	9.40	10.40
DF13- 8P-1.25DS(50)	CL536-0157-3-50	8	8.75	10.65	11.65
DF13- 9P-1.25DS(50)	CL536-0158-6-50	9	10.00	11.90	12.90
DF13-10P-1.25DS(50)	CL536-0159-9-50	10	11.25	13.15	14.15
DF13-11P-1.25DS(50)	CL536-0160-8-50	11	12.50	14.40	15.40
DF13-12P-1.25DS(50)	CL536-0161-0-50	12	13.75	15.65	16.65
DF13-14P-1.25DS(50)	CL536-0163-6-50	14	16.25	18.15	19.15
DF13-15P-1.25DS(50)	CL536-0164-9-50	15	17.50	19.40	20.40

2 APPLICATION FIGURE

RECOMMENDED PATTERN (BOARD THICKNESS 1mm)

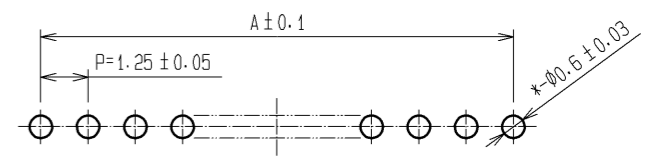
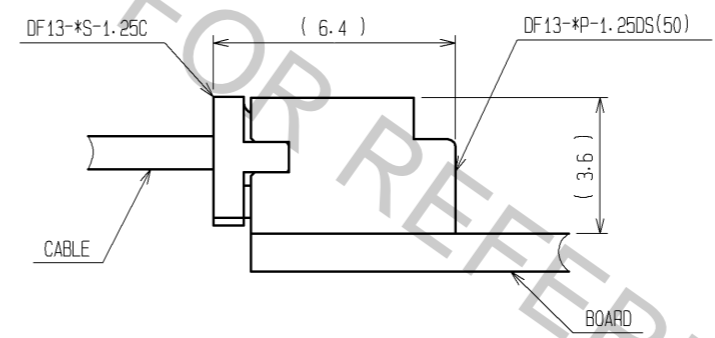

NOTE 1 WHEN THIS CONNECTOR HAS TWO OR THREE CONTACTS, THE LOCK OF CONNECTOR SHALL BE SET AT THE CENTER OF HOUSING. IN CASE THAT THE NUMBER OF CONTACTS IS MORE THAN FOUR, THE TWO LOCKS SHALL BE SET IN ACCORDANCE WITH THE LEFT DRAWINGS.

2 WHEN THIS CONNECTOR MATES WITH DF13-\*S-1.25C, THE MATING LENGTH IS 6.4mm.

2	BRASS	SURFACE:GOLD PLATED 0.2µm min. UNDER:NICKLE PLATED 0.5µm min.	4	ELASTOMER	STOPPER, GRAY
1	POLYAMIDE	BEIGE(NATURAL), UL94V-0	3	P S	ELECTROSTATIC PROTECTION, CLEAR
NO.	MATERIAL	FINISH, REMARKS	NO.	MATERIAL	FINISH, REMARKS
UNITS	mm	SCALE 5:1	COUNT	DESCRIPTION OF REVISIONS	
DESIGNED		CHECKED		DATE	
APPROVED : TS. SAKATA		08.11.17		DRAWING NO. EDC3-162420-04	
CHECKED : TS. KUMAZAWA		08.11.14		PART NO. DF13-*P-1.25DS(50)	
DESIGNED : SN. KOBAYASHI		08.11.14		CODE NO. CL536-	
DRAWN : YK. NAKATSU		08.11.11			

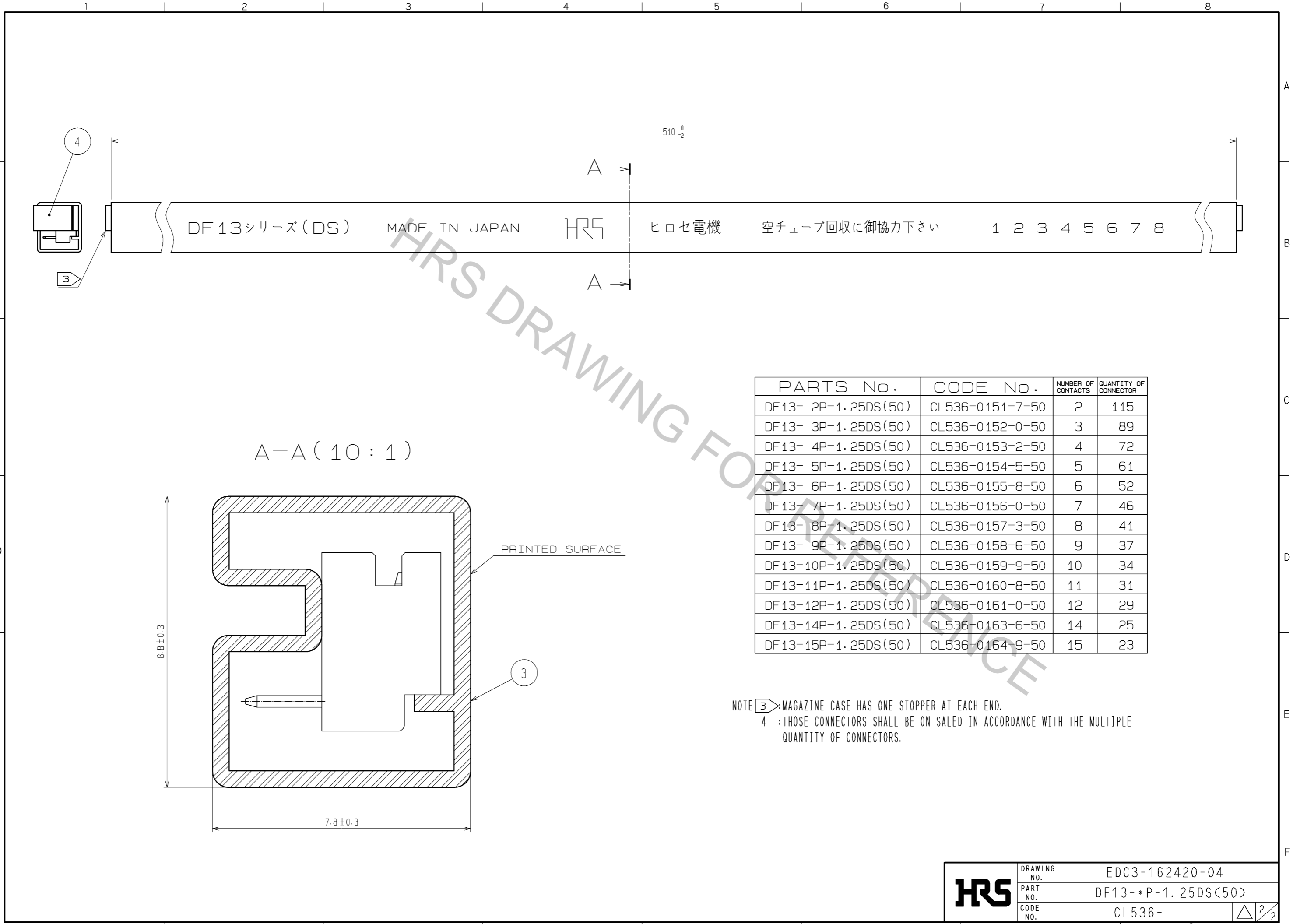

A-A (10:1)

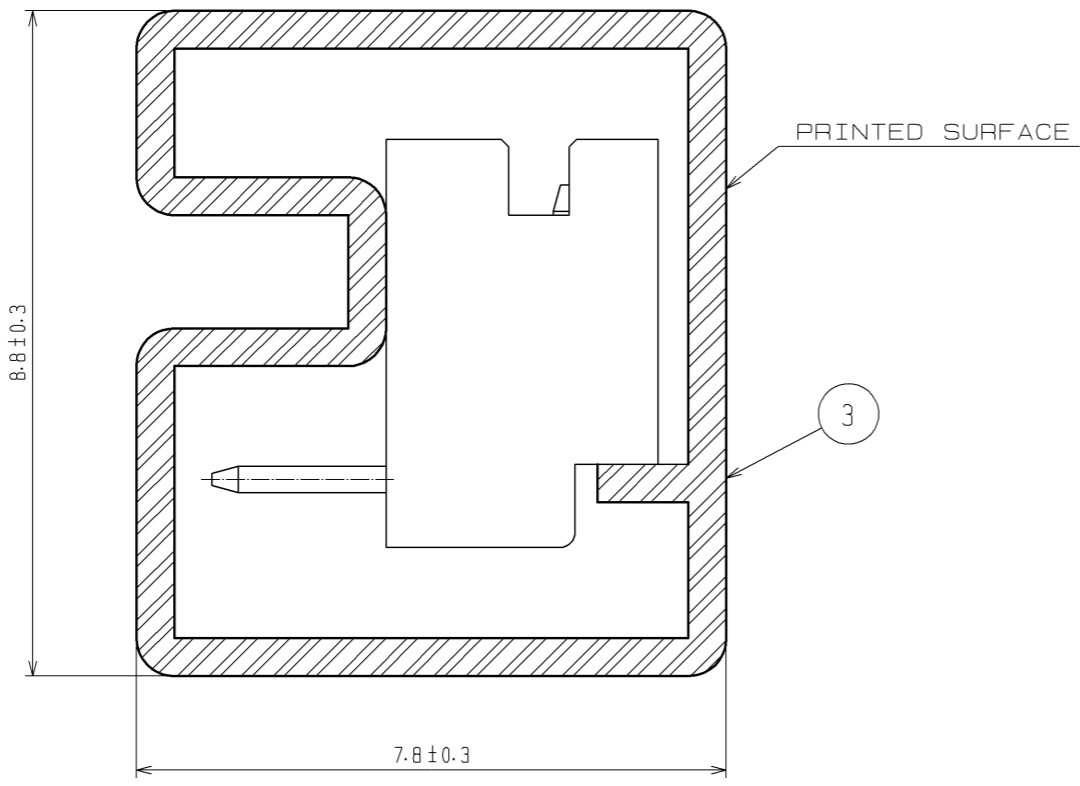

PARTS No.	CODE No.	NUMBER OF CONTACTS	QUANTITY OF CONNECTOR
DF13- 2P-1.25DS(50)	CL536-0151-7-50	2	115
DF13- 3P-1.25DS(50)	CL536-0152-0-50	3	89
DF13- 4P-1.25DS(50)	CL536-0153-2-50	4	72
DF13- 5P-1.25DS(50)	CL536-0154-5-50	5	61
DF13- 6P-1.25DS(50)	CL536-0155-8-50	6	52
DF13- 7P-1.25DS(50)	CL536-0156-0-50	7	46
DF13- 8P-1.25DS(50)	CL536-0157-3-50	8	41
DF13- 9P-1.25DS(50)	CL536-0158-6-50	9	37
DF13-10P-1.25DS(50)	CL536-0159-9-50	10	34
DF13-11P-1.25DS(50)	CL536-0160-8-50	11	31
DF13-12P-1.25DS(50)	CL536-0161-0-50	12	29
DF13-14P-1.25DS(50)	CL536-0163-6-50	14	25
DF13-15P-1.25DS(50)	CL536-0164-9-50	15	23

NOTE ③: MAGAZINE CASE HAS ONE STOPPER AT EACH END.  
 ④: THOSE CONNECTORS SHALL BE ON SALED IN ACCORDANCE WITH THE MULTIPLE QUANTITY OF CONNECTORS.

<b>HRS</b>	DRAWING NO.	EDC3-162420-04
	PART NO.	DF13-*P-1.25DS(50)
	CODE NO.	CL536-

△ 2/2