

Insulated Gate Bipolar Transistor

Features

- Standard: Optimized for minimum saturation voltage and low operating frequencies (< 1kHz)
- Generation 4 IGBT design provides tighter parameter distribution and higher efficiency than Generation 3
- Industry standard TO-247AD package
- Lead-Free
- Automotive Qualified*

Benefits

- Generation 4 IGBT's offer highest efficiency available
- IGBT's optimized for specified application conditions
- Designed to be a "drop-in" replacement for equivalent industry-standard Generation 3 IR IGBT's

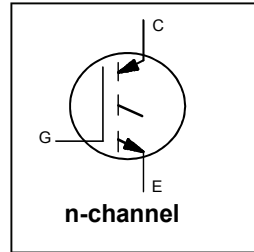

$V_{CES} = 600V$
$V_{CE(ON)} \text{ typ.} = 1.32V$
@ $V_{GE} = 15V, I_C = 31A$

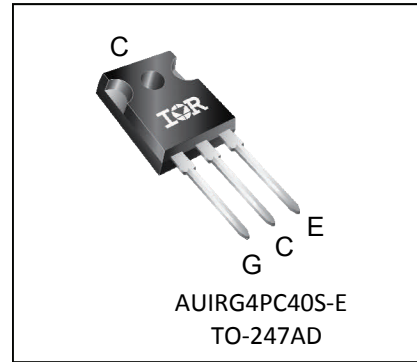

G	C	E
Gate	Collector	Emitter

Base part number	Package Type	Standard Pack		Orderable Part Number
		Form	Quantity	
AUIRG4PC40S-E	TO-247AD	Tube	25	AUIRG4PC40S-E

Absolute Maximum Ratings

	Parameter	Max.	Units
V_{CES}	Collector-to-Emitter Voltage	600	V
$I_C @ T_C = 25^\circ C$	Continuous Collector Current	60	A
$I_C @ T_C = 100^\circ C$	Continuous Collector Current	31	
I_{CM}	Pulse Collector Current ①	120	
I_{LM}	Clamped Inductive Load Current ②	120	
V_{GE}	Continuous Gate-to-Emitter Voltage	± 20	V
E_{ARV}	Reverse Voltage Avalanche Energy ③	15	
$P_D @ T_C = 25^\circ C$	Maximum Power Dissipation	160	W
$P_D @ T_C = 100^\circ C$	Maximum Power Dissipation	65	
T_J T_{STG}	Operating Junction and Storage Temperature Range	-55 to +150	C
	Soldering Temperature, for 10 sec.	300 (0.063 in. (1.6mm) from case)	
	Mounting Torque, 6-32 or M3 Screw	10 lbf-in (1.1 N-m)	

Thermal Resistance

	Parameter	Typ.	Max.	Units
$R_{\theta JC}$	Thermal Resistance Junction-to-Case	—	0.77	$^\circ C/W$
$R_{\theta CS}$	Thermal Resistance, Case-to-Sink (flat, greased surface)	0.24	—	
$R_{\theta JA}$	Thermal Resistance, Junction-to-Ambient (typical socket mount)	—	40	
Wt	Weight	6 (0.21)	—	g (oz)

* Qualification standard can be found at [http:// www.irf.com/](http://www.irf.com/)

Electrical Characteristics @ T_J = 25°C (unless otherwise specified)

	Parameter	Min.	Typ.	Max.	Units	Conditions
V _{(BR)CES}	Collector-to-Emitter Breakdown Voltage	600	—	—	V	V _{GE} = 0V, I _C = 250μA
V _{(BR)ECS}	Emitter-to-Collector Breakdown Voltage ④	18	—	—		V _{GE} = 0V, I _C = 1.0A
ΔV _{(BR)CES} /ΔT _J	Temperature Coeff. of Breakdown Voltage	—	0.75	—	V/°C	V _{GE} = 0V, I _C = 1mA
V _{CE(on)}	Collector-to-Emitter Saturation Voltage	—	1.32	1.5	V	I _C = 31A, V _{GE} = 15V, T _J = 25°C
		—	1.68	—		I _C = 60A, V _{GE} = 15V, See Fig. 2,5
		—	1.32	—		I _C = 31A, V _{GE} = 15V, T _J = 150°C
V _{GE(th)}	Gate Threshold Voltage	3.0	—	6.0	V	V _{CE} = V _{GE} , I _C = 250μA
ΔV _{GE(th)} /ΔT _J	Threshold Voltage Temperature Coeff.	—	-9.3	—	mV/°C	V _{CE} = V _{GE} , I _C = 250μA
g _{fe}	Forward Transconductance⑤	12	21	—	S	V _{CE} = 100V, I _C = 31A
I _{CES}	Collector-to-Emitter Leakage Current	—	—	250	μA	V _{GE} = 0V, V _{CE} = 600V
		—	—	2.0		V _{GE} = 0V, V _{CE} = 10V, T _J = 25°C
		—	—	1000		V _{GE} = 0V, V _{CE} = 600V, T _J = 150°C
I _{GES}	Gate-to-Emitter Leakage Current	—	—	±100	nA	V _{GE} = ±20V

Switching Characteristics @ T_J = 25°C (unless otherwise specified)

	Parameter	Min.	Typ.	Max	Units	Conditions
Q _g	Total Gate Charge (turn-on)	—	100	150	nC	I _C = 31A V _{GE} = 15V V _{CC} = 400V See Fig.8
Q _{ge}	Gate-to-Emitter Charge (turn-on)	—	14	21		
Q _{gc}	Gate-to-Collector Charge (turn-on)	—	34	51		
t _{d(on)}	Turn-On delay time	—	22	—	ns	I _C = 31A, V _{CC} = 480V, V _{GE} =15V R _G = 10Ω, T _J = 25°C Energy losses include "tail"
t _r	Rise time	—	18	—		
t _{d(off)}	Turn-Off delay time	—	650	980		
t _f	Fall time	—	380	570		
E _{on}	Turn-On Switching Loss	—	0.45	—	mJ	See Fig. 10, 11, 13, 14
E _{off}	Turn-Off Switching Loss	—	6.5	—		
E _{ts}	Total Switching Loss	—	6.95	9.9		
t _{d(on)}	Turn-On delay time	—	23	—	ns	I _C = 31A, V _{CC} = 480V, V _{GE} =15V R _G = 10Ω, T _J = 150°C Energy losses include "tail"
t _r	Rise time	—	21	—		
t _{d(off)}	Turn-Off delay time	—	1000	—		
t _f	Fall time	—	940	—		
E _{ts}	Total Switching Loss	—	12	—	mJ	See Fig. 13, 14
L _E	Internal Emitter Inductance	—	13	—	nH	Measured 5mm from package
C _{ies}	Input Capacitance	—	2200	—	pF	V _{GE} = 0V V _{CC} = 30V f = 1.0Mhz See Fig. 7
C _{oes}	Output Capacitance	—	140	—		
C _{res}	Reverse Transfer Capacitance	—	26	—		

Notes:

- ① Repetitive rating; V_{GE} = 20V, pulse width limited by max. junction temperature. (See fig. 13b)
- ② V_{CC} = 80%(V_{CES}), V_{GE} = 20V, L = 10μH, R_G = 10Ω, (See fig. 13a)
- ③ Repetitive rating; pulse width limited by maximum junction temperature.
- ④ Pulse width ≤ 80μs; duty factor ≤ 0.1%.
- ⑤ Pulse width 5.0μs, single shot.

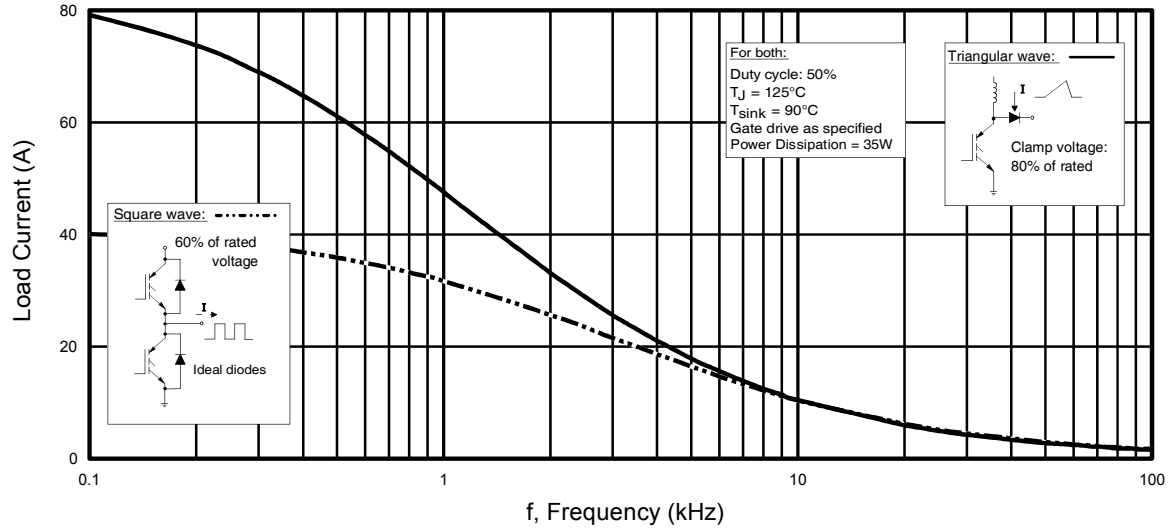

Fig. 1 - Typical Load Current vs. Frequency
 (For square wave, $I = I_{RMS}$ of fundamental; for triangular wave, $I = I_{PK}$)

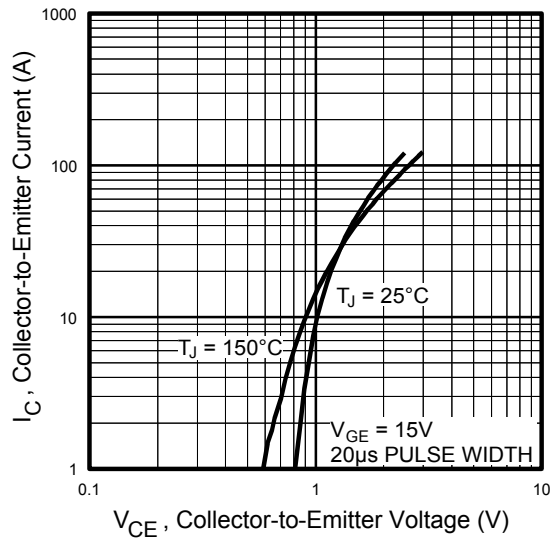

Fig. 2 - Typical Output Characteristics

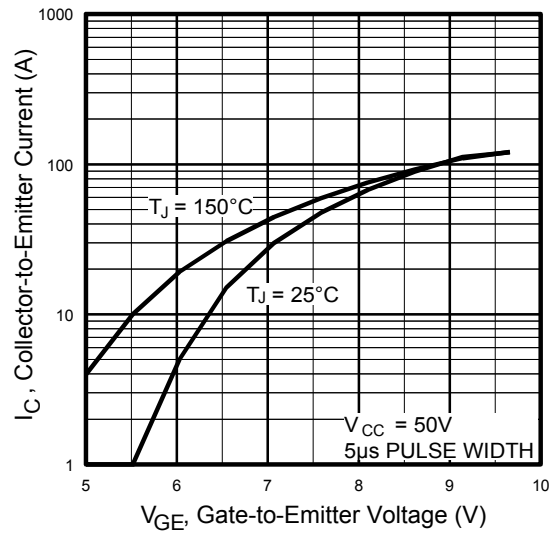

Fig. 3 - Typical Transfer Characteristics

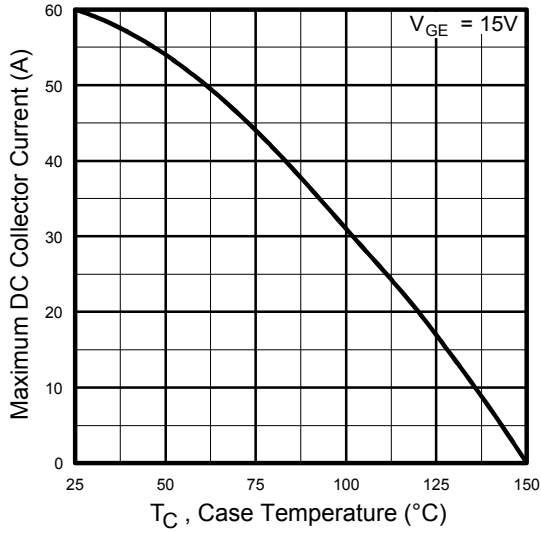

Fig. 4 - Maximum Collector Current vs. Case Temperature

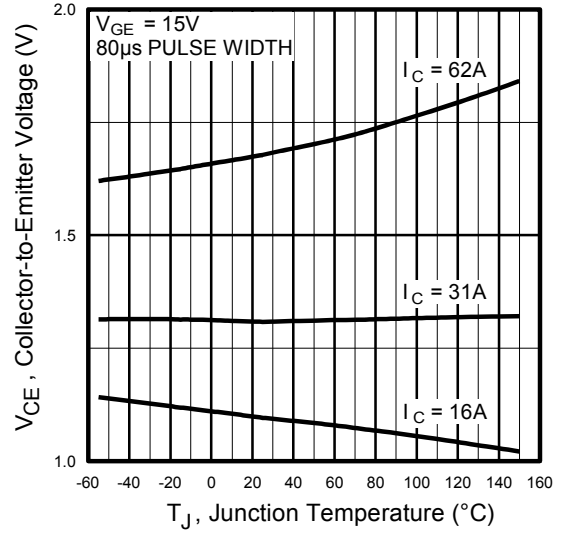

Fig. 5 - Collector-to-Emitter Voltage vs. Junction Temperature

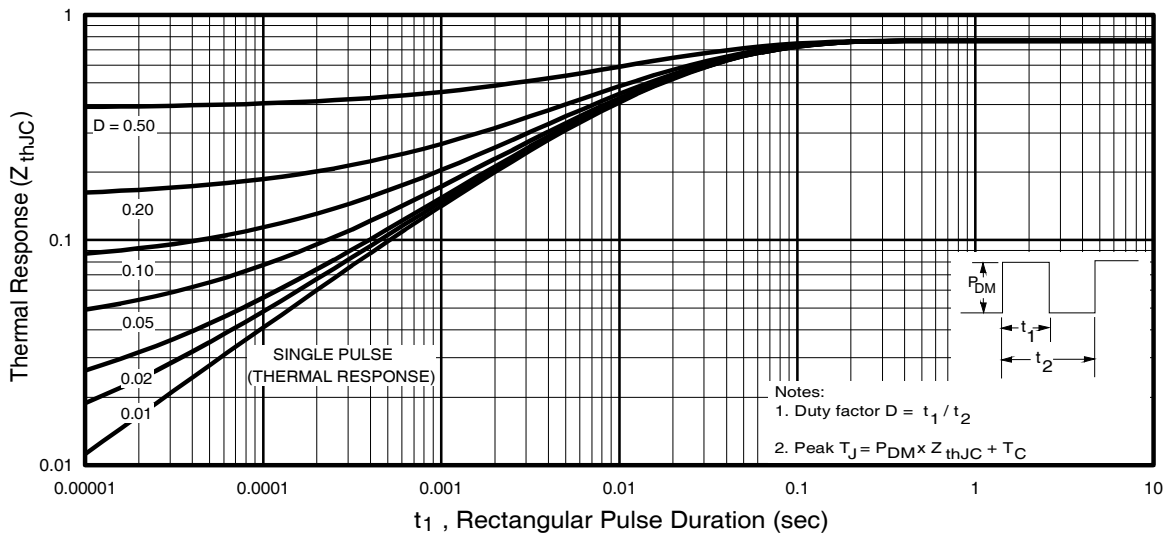

Fig. 6 - Maximum Effective Transient Thermal Impedance, Junction-to-Case

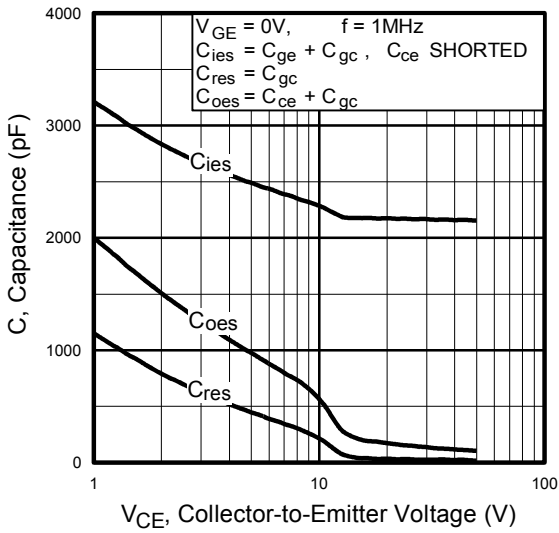

Fig. 7 - Typical Capacitance vs. Collector-to-Emitter Voltage

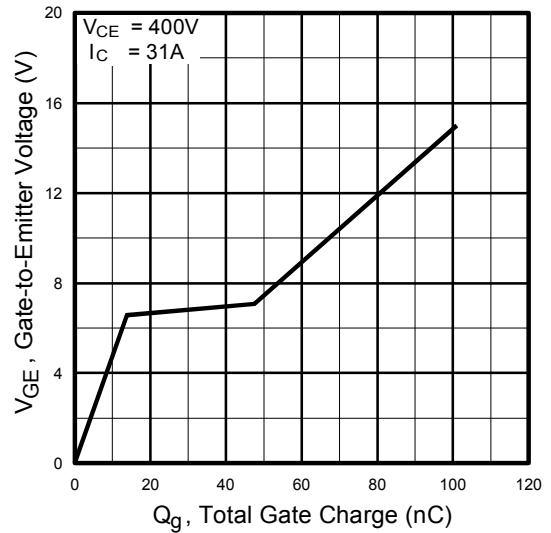

Fig. 8 - Typical Gate Charge vs. Gate-to-Emitter Voltage

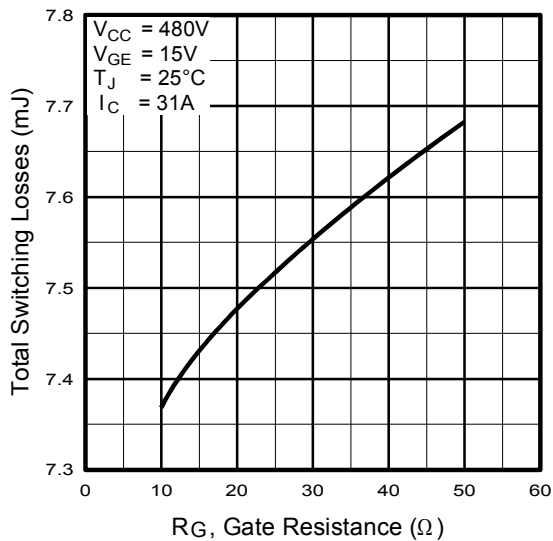

Fig. 9 - Typical Switching Losses vs. Gate Resistance

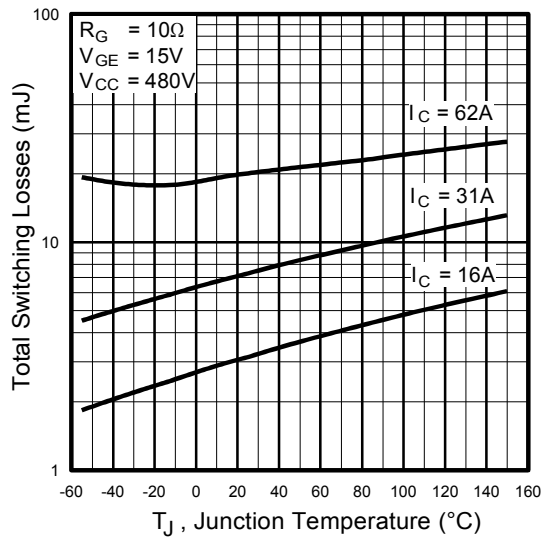

Fig. 10 - Typical Switching Losses vs. Junction Temperature

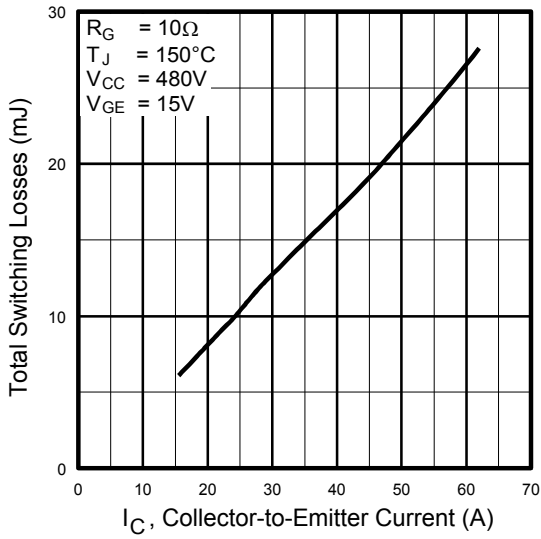

Fig. 11 - Typical Switching Losses vs. Collector-to-Emitter Current

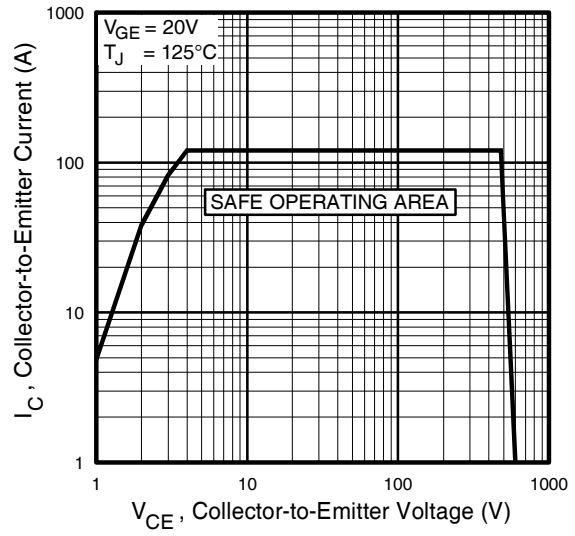
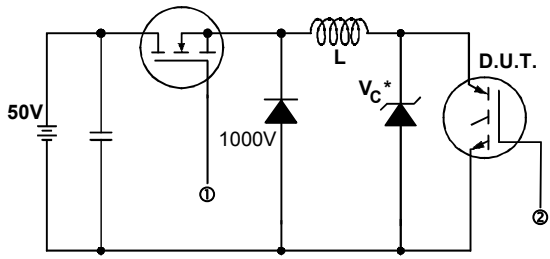

Fig. 12 - Turn-Off SOA



* Driver same type as D.U.T.; $V_c = 80\%$ of $V_{ce(max)}$
 * Note: Due to the 50V power supply, pulse width and inductor will increase to obtain rated I_d .

Fig. 13a - Clamped Inductive Load Test Circuit

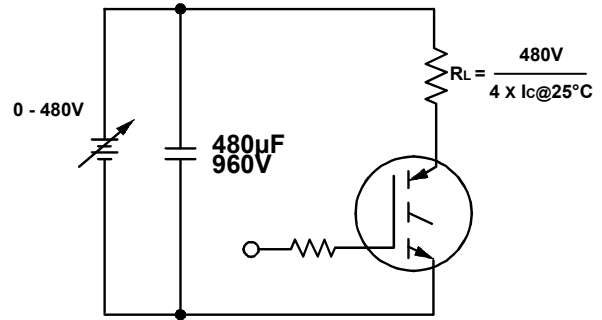
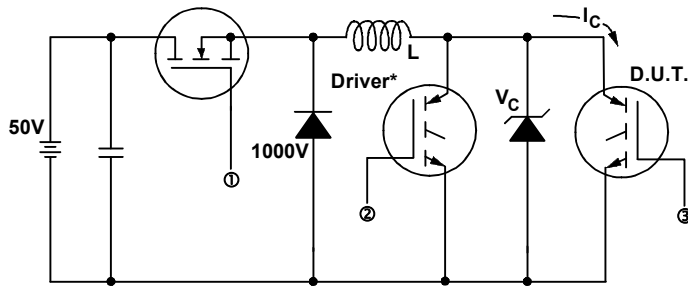

Fig. 13b - Pulsed Collector Current Test Circuit



* Driver same type as D.U.T., $V_c = 480V$

Fig. 14a - Switching Loss Test Circuit

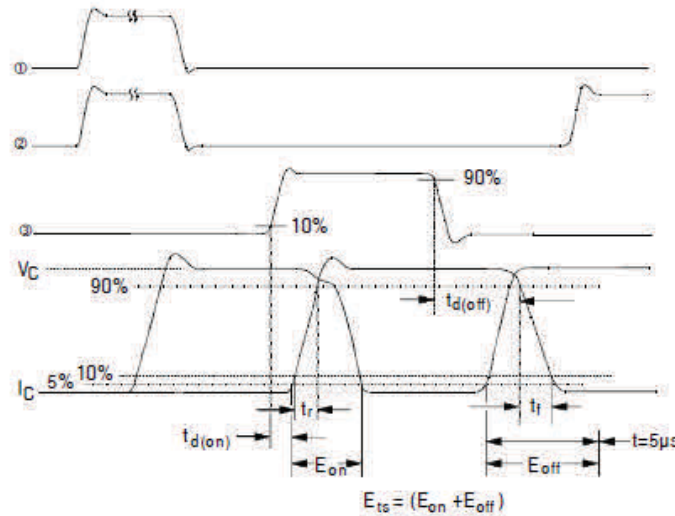
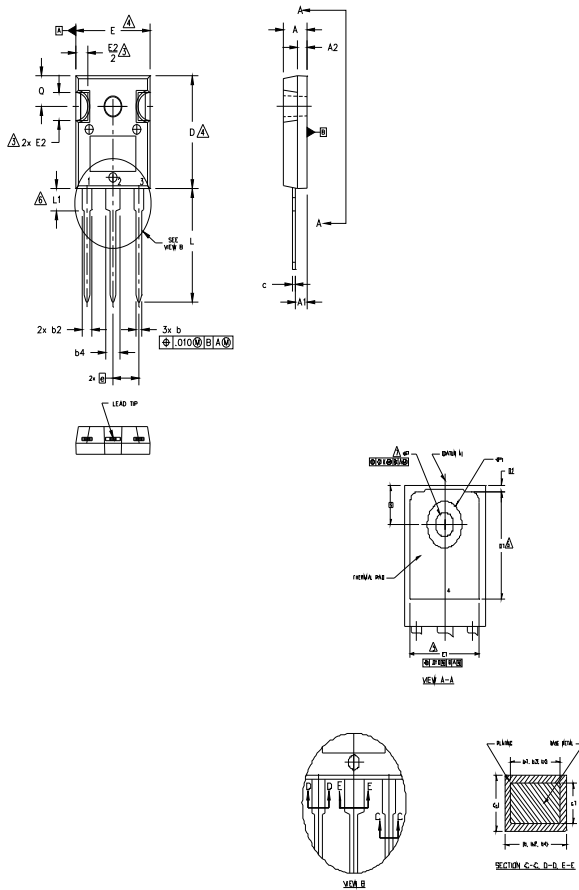

Fig. 14b - Switching Loss Waveforms

TO-247AD Package Outline

Dimensions are shown in millimeters (inches)



NOTES:

1. DIMENSIONING AND TOLERANCING AS PER ASME Y14.5M 1994.
2. DIMENSIONS ARE SHOWN IN INCHES.
3. CONTOUR OF SLOT OPTIONAL.
4. DIMENSION D & E DO NOT INCLUDE MOLD FLASH. MOLD FLASH SHALL NOT EXCEED .005" (0.127) PER SIDE. THESE DIMENSIONS ARE MEASURED AT THE OUTERMOST EXTREMES OF THE PLASTIC BODY.
5. THERMAL PAD CONTOUR OPTIONAL WITHIN DIMENSIONS D1 & E1.
6. LEAD FINISH UNCONTROLLED IN L1.
7. ØP TO HAVE A MAXIMUM DRAFT ANGLE OF 1.5 ° TO THE TOP OF THE PART WITH A MAXIMUM HOLE DIAMETER OF .154 INCH.
8. OUTLINE CONFORMS TO JEDEC OUTLINE TO-247AD.

SYMBOL	DIMENSIONS				NOTES
	INCHES		MILLIMETERS		
	MIN.	MAX.	MIN.	MAX.	
A	.183	.209	4.65	5.31	
A1	.087	.102	2.21	2.59	
A2	.059	.098	1.50	2.49	
b	.039	.056	0.99	1.40	
b1	.039	.053	0.99	1.35	
b2	.065	.094	1.65	2.39	
b3	.065	.092	1.65	2.34	
b4	.102	.135	2.59	3.43	
b5	.102	.133	2.59	3.38	
c	.015	.036	0.38	0.89	
c1	.015	.033	0.38	0.84	
D	.776	.815	19.71	20.70	4
D1	.515	-	13.08	-	5
D2	.020	.053	0.51	1.35	
E	.602	.625	15.29	15.87	4
E1	.530	-	13.46	-	
E2	.178	.216	4.52	5.49	
e	.215 BSC		5.48 BSC		
Øk	.010		0.25		
L	.780	.827	19.57	21.00	
L1	.146	.169	3.71	4.29	
ØP	.140	.144	3.56	3.66	
ØP1	-	.291	-	7.39	
Q	.209	.224	5.31	5.69	
S	.217 BSC		5.51 BSC		

LEAD ASSIGNMENTS

HEXFET

- 1.- GATE
- 2.- DRAIN
- 3.- SOURCE
- 4.- DRAIN

IGBTs, CoPACK

- 1.- GATE
- 2.- COLLECTOR
- 3.- EMITTER
- 4.- COLLECTOR

DIODES

- 1.- ANODE/OPEN
- 2.- CATHODE
- 3.- ANODE

TO-247AD Part Marking Information

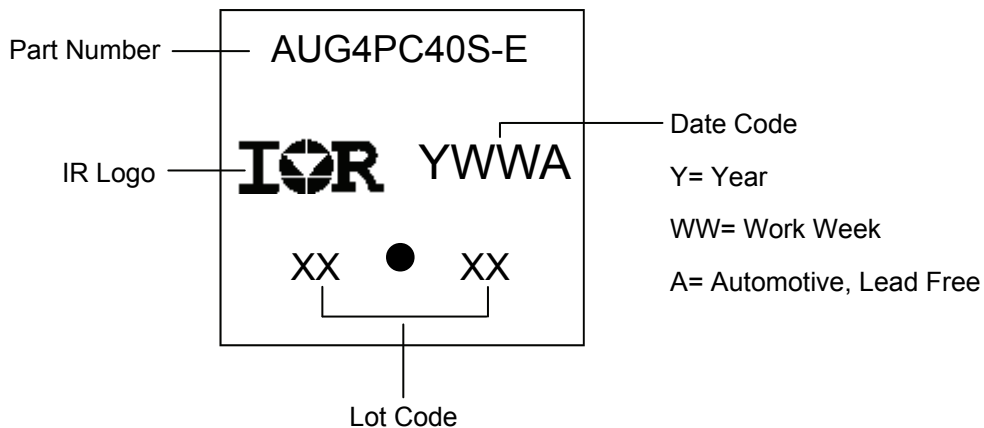

TO-247AD package is not recommended for Surface Mount Application.

Note: For the most current drawing please refer to IR website at <http://www.irf.com/package/>

Qualification Information†

Qualification Level		Automotive (per AEC-Q101) ††	
		Comments: This part number(s) passed Automotive qualification. IR's Industrial and Consumer qualification level is granted by extension of the higher Automotive level.	
Moisture Sensitivity Level		TO-247AD	N/A
ESD	Human Body Model	Class H1C (+/- 2000V) AEC-Q101-001	
	Charged Device Model	Class C5 (+/- 2000V) AEC-Q101-005	
RoHS Compliant		Yes	

† Qualification standards can be found at International Rectifier's web site: <http://www.irf.com/>

†† Exceptions to AEC-Q101 requirements are noted in the qualification report.

IMPORTANT NOTICE

Unless specifically designated for the automotive market, International Rectifier Corporation and its subsidiaries (IR) reserve the right to make corrections, modifications, enhancements, improvements, and other changes to its products and services at any time and to discontinue any product or services without notice. Part numbers designated with the “AU” prefix follow automotive industry and / or customer specific requirements with regards to product discontinuance and process change notification. All products are sold subject to IR’s terms and conditions of sale supplied at the time of order acknowledgment.

IR warrants performance of its hardware products to the specifications applicable at the time of sale in accordance with IR’s standard warranty. Testing and other quality control techniques are used to the extent IR deems necessary to support this warranty. Except where mandated by government requirements, testing of all parameters of each product is not necessarily performed.

IR assumes no liability for applications assistance or customer product design. Customers are responsible for their products and applications using IR components. To minimize the risks with customer products and applications, customers should provide adequate design and operating safeguards.

Reproduction of IR information in IR data books or data sheets is permissible only if reproduction is without alteration and is accompanied by all associated warranties, conditions, limitations, and notices. Reproduction of this information with alterations is an unfair and deceptive business practice. IR is not responsible or liable for such altered documentation. Information of third parties may be subject to additional restrictions.

Resale of IR products or serviced with statements different from or beyond the parameters stated by IR for that product or service voids all express and any implied warranties for the associated IR product or service and is an unfair and deceptive business practice. IR is not responsible or liable for any such statements.

IR products are not designed, intended, or authorized for use as components in systems intended for surgical implant into the body, or in other applications intended to support or sustain life, or in any other application in which the failure of the IR product could create a situation where personal injury or death may occur. Should Buyer purchase or use IR products for any such unintended or unauthorized application, Buyer shall indemnify and hold International Rectifier and its officers, employees, subsidiaries, affiliates, and distributors harmless against all claims, costs, damages, and expenses, and reasonable attorney fees arising out of, directly or indirectly, any claim of personal injury or death associated with such unintended or unauthorized use, even if such claim alleges that IR was negligent regarding the design or manufacture of the product.

IR products are neither designed nor intended for use in military/aerospace applications or environments unless the IR products are specifically designated by IR as military-grade or “enhanced plastic.” Only products designated by IR as military-grade meet military specifications. Buyers acknowledge and agree that any such use of IR products which IR has not designated as military-grade is solely at the Buyer’s risk, and that they are solely responsible for compliance with all legal and regulatory requirements in connection with such use.

IR products are neither designed nor intended for use in automotive applications or environments unless the specific IR products are designated by IR as compliant with ISO/TS 16949 requirements and bear a part number including the designation “AU”. Buyers acknowledge and agree that, if they use any non-designated products in automotive applications, IR will not be responsible for any failure to meet such requirements

For technical support, please contact IR’s Technical Assistance Center

<http://www.irf.com/technical-info/>

WORLD HEADQUARTERS:

101N.Sepulveda blvd, El Segundo, California 90245

Tel: (310) 252-7105