

ESY, Aluminum Electrolytic, 105C LowZ, 330 uF, 20%, 25 VDC, -40/+105C, Lead Spacing = 3.5mm

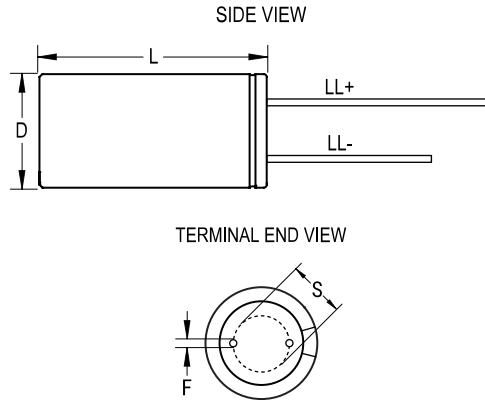

Dimensions	
D	8mm +/-0.5mm
L	16mm +2mm
S	3.5mm +/-0.5mm
LL Negative	15mm MIN
LL Positive	20mm MIN
F	0.6mm NOM

Packaging Specifications	
Packaging:	Bulk, Bag
Packaging Quantity:	5000

General Information	
Supplier:	KEMET
Series:	ESY
Dielectric:	Aluminum Electrolytic
Description:	LowZ Single Ended Aluminum Electrolytic
Features:	Low Z
RoHS:	Yes
Lead:	Wire Leads

Specifications	
Capacitance:	330 uF
Capacitance Tolerance:	20%
Voltage DC:	25 VDC, 32 VDC (Surge)
Temperature Range:	-40/+105C
Rated Temperature:	105C
Life:	3000 Hrs
Dissipation Factor:	14.00%
Resistance:	0.056 Ohms (100kHz)
Ripple Current:	1000 mAmps (100kHz 105C)
Leakage Current:	82.5 uA (2min 20C)
Impedance Ratio at -25C:	2
Impedance Ratio at -40C:	3