

## TINA-RS

~13° spot beam optimized for LUXEON Rebel.  
Assembly with holder and installation tape.

### TECHNICAL SPECIFICATIONS:

Dimensions	Ø 16.1 mm
Height	9.4 mm
Fastening	tape, pin
Colour	black
Box size	470 x 240 x 105 mm
Box weight	4.1 kg
Quantity in Box	2016 pcs
ROHS compliant	yes ⓘ



### MATERIAL SPECIFICATIONS:

Component	Type	Material	Colour
TINA-XP-RS	Lens	PMMA	clear
TINA-H-TAPE-RE-BLK	Holder	PC	black
TINA-TAPE3	Tape	PU tape	black

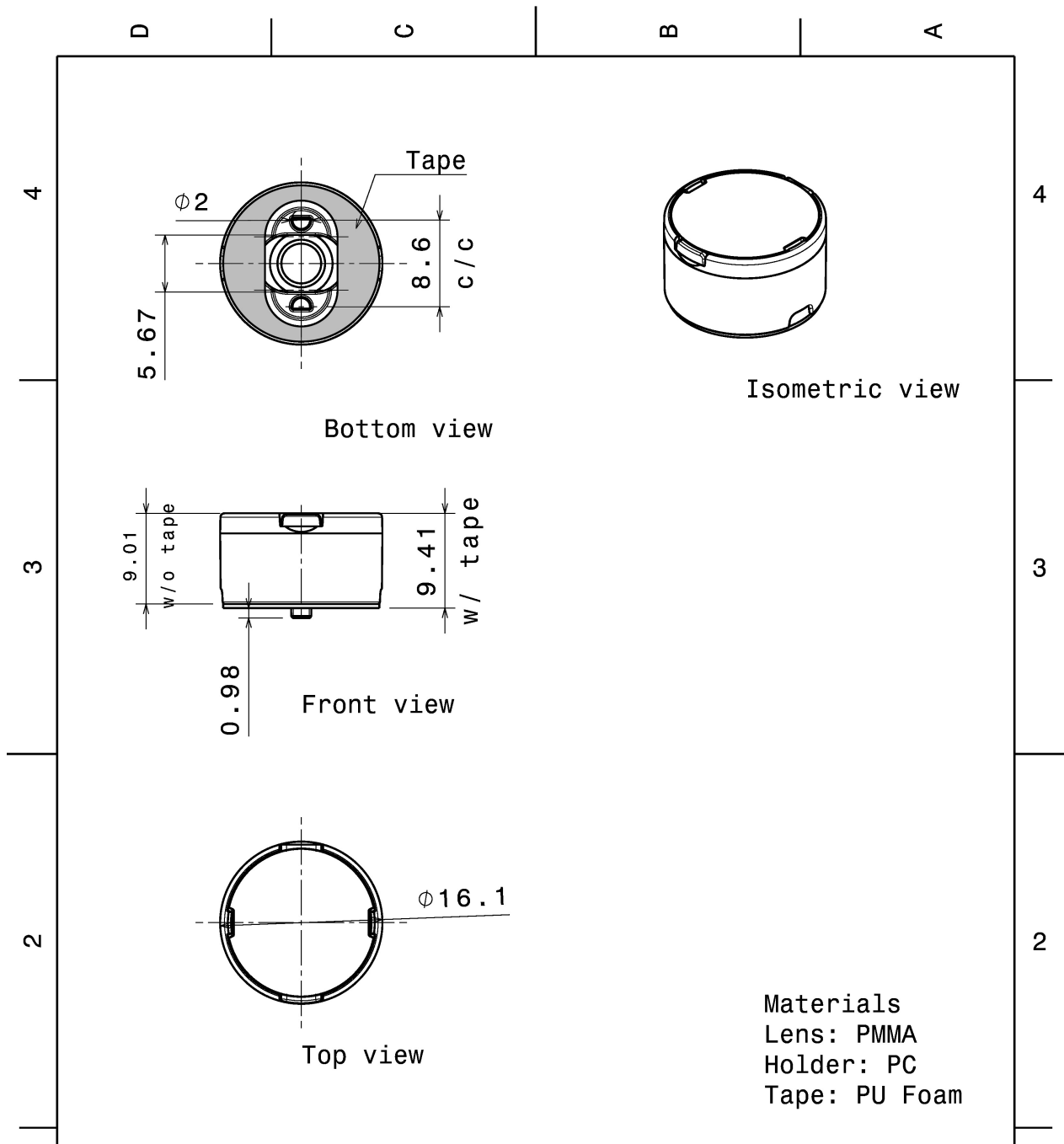

Materials  
 Lens: PMMA  
 Holder: PC  
 Tape: PU Foam

This drawing is our property. It can't be reproduced or communicated without our written agreement.		<b>LEDiL</b> Ledil Oy Salorankatu 10 FIN 24240 SALO Finland	
DRAWING TITLE		Mechanical Drawing	
DRAWN BY	DATE	TINA-RE	
as	10.9.2012		
CHECKED BY	DATE	SIZE	PART NUMBER
sn	-	A4	TINA-RE
DESIGNED BY	DATE	SCALE	WEIGHT
-	-	2:1	1,46 g
		SHEET	1/1

#### PHOTOMETRIC DATA (MEASURED):



LED XB-H  
 FWHM 15.0°  
 Efficiency 88 %  
 Peak intensity 10.300 cd/Im  
 Required components:

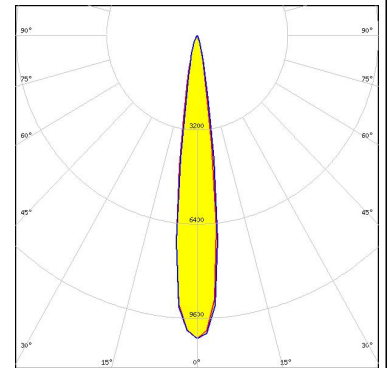
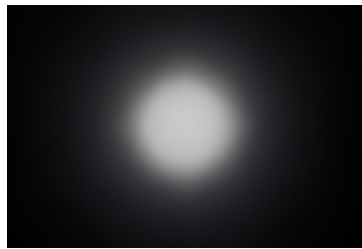

LED LUXEON Rebel  
 FWHM 10.0°  
 Efficiency 93 %  
 Peak intensity 16.900 cd/Im  
 Required components:



LED LUXEON TX  
 FWHM 15.0°  
 Efficiency 88 %  
 Peak intensity 10.500 cd/Im  
 Required components:

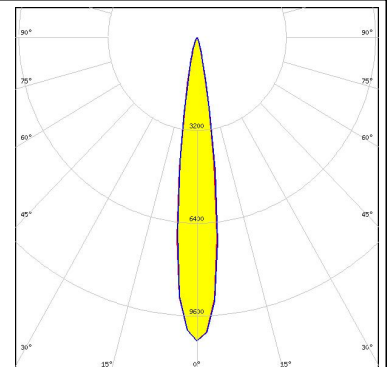
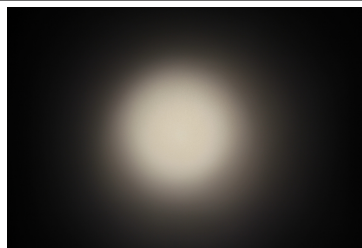

LED LUXEON Z ES  
 FWHM 12.0°  
 Efficiency 89 %  
 Peak intensity 19.800 cd/Im  
 Required components:

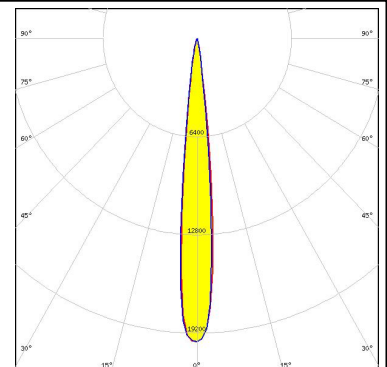
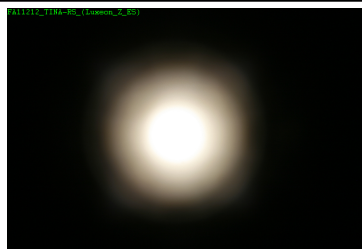

### PHOTOMETRIC DATA (SIMULATED):

#### LUMILEDS

LED LUXEON H50-2  
FWHM 16.0°  
Efficiency 92 %  
Peak intensity 8.500 cd/lm  
Required components:

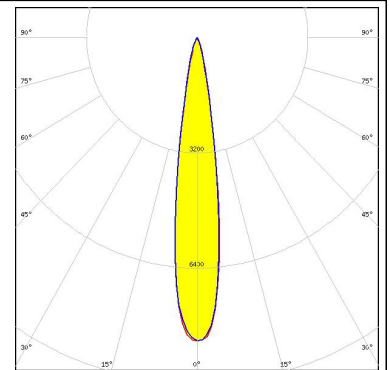

#### LUMILEDS

LED LUXEON T  
FWHM 16.0°  
Efficiency 92 %  
Peak intensity 8.840 cd/lm  
Required components:

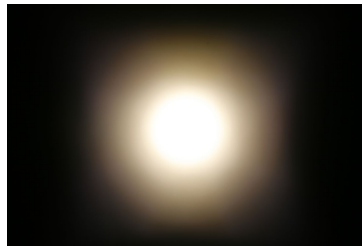

### GENERAL INFORMATION:

NOTE: The typical beam angle will be changed by different color, chip size and chip position tolerance. The typical total beam angle is the full angle measured where the luminous intensity is half of the peak value.

### MATERIALS:

As part of our continuous research and improvement processes, and to ensure the best possible quality and availability of our products, LEDiL reserves the right to change material grades without notice.

### PRODUCT DATA USER AGREEMENT AND DISCLAIMER:

The measured data in the provided downloadable LEDiL Product Datasheets and Mechanical 2D-Drawings is rounded and provided as reference for planning. LEDiL Oy's optical specifications have been verified by conducting performance testing of the products in accordance with the company's quality system. The reported data are averaged results of multiple measurements with typical variation. LEDiL Oy reserves the right to without prior notification make changes and improvements to its products.

LEDiL Oy assumes neither warranty, nor guarantee nor any other liability of any kind for the contents and correctness of the provided data. The provided data has been generated with highest diligence but the provided data may in reality not represent the complete possible variation range of all intrinsic parameters. Therefore, in certain cases a deviation from the provided data could occur.

LEDiL Oy reserves the right to undertake technical changes of its products without further notification which could lead to changes in the provided data. LEDiL Oy assumes no liability of any kind for the possible deviation from any provided data or any other damage resulting from the usage of the provided data.

The user agrees to this disclaimer and user agreement with the download or usage of the provided files.

#### LEDiL Oy

Joensuunkatu 13  
FI-24240 SALO  
Finland

#### LEDiL Inc.

228 West Page Street  
Suite D  
Sycamore IL 60178  
USA

#### Local sales and technical support

[www.ledil.com/  
where\\_to\\_buy](http://www.ledil.com/where_to_buy)

#### Shipping locations

Salo, Finland  
Hong Kong, China

#### Distribution Partners

[www.ledil.com/  
where\\_to\\_buy](http://www.ledil.com/where_to_buy)